

# DRVNA INDUSTRIJA

ZNANSTVENI ČASOPIS ZA PITANJA DRVNE TEHNOLOGIJE • ZAGREB • VOLUMEN 70 • BROJ 4  
SCIENTIFIC JOURNAL OF WOOD TECHNOLOGY • ZAGREB • VOLUME 70 • NUMBER 4



*Quercus alba* L.

4/19

# DRVNA INDUSTRIJA

ZNANSTVENI ČASOPIS ZA PITANJA DRVNE TEHNOLOGIJE  
SCIENTIFIC JOURNAL OF WOOD TECHNOLOGY

**IZDAVAČ I UREDNIŠTVO**  
**Publisher and Editorial Office**

Šumarski fakultet Sveučilišta u Zagrebu  
Faculty of Forestry, Zagreb University  
10000 Zagreb, Svetošimunska 25  
Hrvatska – Croatia  
Tel. (+385 1) 235 25 53

**SUIZDAVAČI**  
**Co-Publishers**

Hrvatsko šumarsko društvo, Zagreb  
Hrvatske šume d.o.o., Zagreb  
Hrvatska komora inženjera šumarstva i drvne tehnologije

**OSNIVAČ**  
**Founder**

Institut za drvnoindustrijska istraživanja, Zagreb

**GLAVNA I ODGOVORNA UREDNICA**  
**Editor-in-Chief**

Ružica Beljo Lučić

**POMOĆNIK GLAVNE UREDNICE**  
**Assistant Editor-in-chief**

Josip Miklečić

**UREDNIČKI ODBOR**  
**Editorial Board**

Vlatka Jirouš-Rajković, Hrvatska  
Stjepan Pervan, Hrvatska  
Tomislav Sinković, Hrvatska  
Anka Ozana Čavlović, Hrvatska  
Jaroslav Kljak, Hrvatska  
Bogoslav Šefc, Hrvatska  
Igor Đukić, Hrvatska  
Zoran Vlaović, Hrvatska  
Andreja Pirc Barčić, Hrvatska  
Kristina Klarić, Hrvatska  
Jerzy Smardzewski, Poljska  
Marko Petrič, Slovenija  
Katarina Čufar, Slovenija  
Christian Brischke, Njemačka  
Kazimierz Orłowski, Poljska  
Jakub Sandak, Italija  
Željko Gorišek, Slovenija  
Borche Iliev, Makedonija  
Leon Oblak, Slovenija  
Hubert Paluš, Slovačka

**IZDAVAČKI SAVJET**  
**Publishing Council**

prof. dr. sc. Ivica Grbac (predsjednik),  
prof. dr. sc. Stjepan Risović,  
prof. dr. sc. Stjepan Pervan,  
Šumarski fakultet Sveučilišta u Zagrebu;  
Zdravko Jelčić, dipl. oec., Spin Valis d.d.;  
Krunoslav Jakupčić, dipl. ing., Hrvatske šume d.o.o.;  
Oliver Vlanić, dipl. ing., Hrvatsko šumarsko društvo;  
Mato Ravlić, Hrast Strizivojna d.o.o.;  
Mladen Galeković, PPS-Galeković Tvornica parketa;  
Silvija Zec, dipl. ing., Hrvatska komora inženjera  
šumarstva i drvne tehnologije

**TEHNIČKI UREDNIK**  
**Technical Editor**

Zoran Vlaović

**POMOĆNICA UREDNIŠTVA**  
**Assistant to Editorial Office**

Dubravka Cvetan

**LEKTORICE**  
**Linguistic Advisers**

Zlata Babić, prof. (hrvatski – Croatian)  
Maja Zajšek-Vrhovac, prof. (engleski – English)

DRVNA INDUSTRIJA je časopis koji objavljuje znanstvene i stručne radove te ostale priloge iz cjelokupnog područja iskorištavanja šuma, istraživanja svojstava i primjene drva, mehaničke i kemijske prerade drva, svih proizvodnih grana te trgovine drvom i drvnim proizvodima.

Časopis izlazi četiri puta u godini.

DRVNA INDUSTRIJA journal contains research contributions and reviews covering the entire field of forest exploitation, wood properties and application, mechanical and chemical conversion and modification of wood, and all aspects of manufacturing and trade of wood and wood products.

The journal is published quarterly.

# Sadržaj

## Contents

**NAKLADA (Circulation):** 700 komada · **ČASOPIS JE REFERIRAN U (Indexed in):** Science Citation Index Expanded, Scopus, CAB Abstracts, Compendex, Environment Index, Veterinary Science Database, Geobase, DOAJ · **PRILOGE** treba slati na adresu Uredništva. Znanstveni i stručni članci se recenziraju. Rukopisi se ne vraćaju. · **MANUSCRIPTS** are to be submitted to the editorial office. Scientific and professional papers are reviewed. Manuscripts will not be returned. · **KONTAKT s uredništvom (Contact with the Editorial)** e-mail: [editordi@sumfak.hr](mailto:editordi@sumfak.hr) · **PRETPLATA (Subscription):** godišnja pretplata (annual subscription) za sve pretplatnike 55 EUR. Pretplata u Hrvatskoj za sve pretplatnike iznosi 300 kn, a za đake, studente i umirovljenike 100 kn, plativo na žiro račun 2360000 – 1101340148 s naznakom "Drvena industrija" · **ČASOPIS SUFINANCIRA** Ministarstvo znanosti i obrazovanja Republike Hrvatske. · **TISAK (Printed by)** – DENONA d.o.o., Getaldićeva 1, Zagreb, tel. 01/2361777, fax. 01/2332753, E-mail: [denona@denona.hr](mailto:denona@denona.hr); URL: [www.denona.hr](http://www.denona.hr) · **DESIGN** Aljoša Brajdić · **ČASOPIS JE DOSTUPAN NA INTERNETU:** <http://drvnaindustrija.sumfak.hr> · **NASLOVNICA** Presjek drva *Quercus alba* L., ksiloteka Zavoda za znanost o drvu, Šumarski fakultet Sveučilišta u Zagrebu

DRVNA INDUSTRIJA · Vol. 70, 4 · str. 317-422 · zima 2019. · Zagreb  
REDAKCIJA DOVRŠENA 2. 12. 2019.

### ORIGINAL SCIENTIFIC PAPERS

<i>Izvorni znanstveni radovi</i> .....	319-418
INVESTIGATION OF TEMPERATURE FIELDS IN THE AIR ENVIRONMENT ABOVE WOOD SUBJECTED TO THERMAL DEGRADATION Ispitivanje temperaturnih polja u zraku iznad drva podvrgnutoga toplinskoj razgradnji <i>Elena Pivarčiova, Štefan Barčík, Jaroslava Štefková, Emil Škultéty</i> .....	319
THE EFFECT OF CHIP SIZE AND ALKALINE PRE-HYDROLYSIS CONDITIONS ON FOLLOWING SODA PULPING OF HORNBEAM WOOD Utjecaj veličine sječke i uvjeta alkalne predhidrolize na natronski postupak proizvodnje celuloze od grabovine <i>Ahmad Jahan Latibari, Abdulrahim Mohebalian, Ajang Tajdini, Shadman Pourmosua</i> .....	329
ASSESSMENT OF EFFICACY AND EFFECTIVENESS OF SOME EXTRACTED BIO-CHEMICALS AS BIO-FUNGICIDES ON WOOD Procjena učinkovitosti i djelotvornosti ekstrahiranih biokemikalija kao fungicida za drvo <i>Mohamed Z. M. Salem, Safa Abd El-Kader Mohamed Hamed, Maisa M. A. Mansour</i> .....	337
IMPACT OF HEAT TREATMENT ON THE QUALITY OF TREE-OF-HEAVEN WOOD Utjecaj toplinske modifikacije na kvalitetu drva pajasena <i>Ioannis Barboutis, Vasiliki Kamperidou</i> .....	351
ECO-FRIENDLY LAMINATED STRAND LUMBER FROM DATE PALM RACHIS: ANALYSIS OF MECHANICAL PROPERTIES BY TAGUCHI DESIGN OF EXPERIMENT Ekološki prihvatljiva uslojena drvonitna građa od lisnih osi palme datulje: analiza mehaničkih svojstava Taguchi metodom pripreme istraživanja <i>Masoud Shafie, Hamid Zarea-Hosseinabadi</i> .....	359
EFFECT OF VENEER DRYING PROCESS ON SOME TECHNOLOGICAL PROPERTIES OF POLYSTYRENE COMPOSITE PLYWOOD PANELS Utjecaj procesa sušenja furnira na tehnološka svojstva kompozitnih uslojenih drvnih ploča vezanih polistirenom <i>Hasan Ozturk, Aydin Demir, Cenk Demirkir, Gursel Colakoglu</i> .....	369
SURFACE ROUGHNESS AND WETTABILITY OF SURFACE DENSIFIED HEAT-TREATED NORWAY SPRUCE ( <i>PICEA ABIES</i> L. KARST.) Hrapavost i stupanj kvašenja ugušćene površine pregrijane smrekovine ( <i>Picea abies</i> L. Karst.) <i>Nadir Ayrilmis, Mirko Kariz, Jin Heon Kwon, Manja Kitek Kuzman</i> .....	377
THE EFFECT OF USING ALUM MORDANT IN WILD CHERRY BARK DYESTUFF FOR THE PRODUCTION OF UV RESISTANT COLORED PAPER Utjecaj aluminijskog fiksatora u bojilu od kore divlje trešnje na proizvodnju obojenog papira otpornoga na UV svjetlost <i>Ayhan Gençer, Ahmet Can, Aysun Mustak, Ülkü Burcu Gitti</i> .....	383
EFFECT OF ACCELERATED WEATHERING TEST ON SELECTED PROPERTIES OF BAMBOO, SCOTS PINE AND ORIENTAL BEECH WOOD TREATED WITH WATERBORNE PRESERVATIVES Utjecaj ubrzanog izlaganja vremenskim utjecajima na svojstva bambusa, drva bora i drva bukve obrađenih zaštitnim sredstvima na bazi vode <i>Elif Topaloglu</i> .....	391
INFLUENCE OF LAYERED STRUCTURE OF COMPOSITE TIMBER FLOOR BOARDS ON THEIR HARDNESS Utjecaj strukture slojeva na tvrdoću višeslojnih podnih obloga <i>Piotr Borysiuk, Izabela Burawska-Kupniewska, Radosław Auriga, Grzegorz Kowaluk, Paweł Kozakiewicz, Marcin Zbiec</i> .....	399
CONSUMER PERCEPTION OF ENVIRONMENTALLY SUSTAINABLE PRODUCTS OF SLOVAK WOOD PROCESSING ENTERPRISES Korisnička percepcija ekološki održivih proizvoda slovačkih drvoprerađivačkih poduzeća <i>Denisa Malá, Mariana Sedláčiková, Josef Drábek, Denis Jelačić, Martina Minárová</i> .....	407
<i>UZ SLIKU S NASLOVNICE / Species on the cover</i> .....	419-420

# Investigation of Temperature Fields in the Air Environment above Wood Subjected to Thermal Degradation

## Ispitivanje temperaturnih polja u zraku iznad drva podvrgnutoga toplinskoj razgradnji

### Original scientific paper • Izvorni znanstveni rad

Received – prispjelo: 24. 4. 2018.

Accepted – prihvaćeno: 20. 11. 2019.

UDK: 630\*812.14; 630\*814.12

<https://doi.org/10.5552/drvind.2019.1817>

**ABSTRACT** • The paper deals with the visualization of thermal fields above the sample body while observing thermal loading of wood. Via holographic interferometry, thermal fields were visualized in a non-contact manner and the values were recorded in 0, 3, 7 and 15 minutes or earlier in case of degradation. In real time, the ongoing processes were recorded in the thermal boundary layer above the surface of sample bodies in dimensions of 43 mm × 40 mm × 10 mm of beech wood in three different directions: longitudinal, radial, tangential cut. The temperatures of isothermal curves above the heated samples and coefficients of heat transfer  $\alpha$  were determined by a quantitative analysis of holographic interferograms. The heat transfer coefficient  $\alpha$  ranged within 4.6-7.4 W/m<sup>2</sup>K. The simulation of heat transfer for the selected samples was prepared by the Fluent programme. Consequently, the measured values from the experiments were compared with the calculated values. There is a correlation between the measured and calculated values.

**Keywords:** temperature fields, beech wood, interferogram, holographic interferometry, heat transfer coefficient

**SAŽETAK** • Rad se bavi vizualizacijom toplinskih polja iznad površine uzorka tijekom zagrijavanja drva. Uz pomoć holografske interferometrije toplinska su polja beskontaktno vizualizirana nakon 0, 3, 7 i 15 minuta ili ranije u slučaju degradacije drva. U stvarnom vremenu zabilježeni su procesi u graničnome toplinskom sloju iznad površine uzorka od bukova drva dimenzija 43 mm × 40 mm × 10 mm u tri različita smjera: uzdužnome, radijalnome i tangencijalnome. Temperature izotermalnih krivulja iznad zagrijanih uzoraka i koeficijenti prolaska topline  $\alpha$  određeni su kvantitativnom analizom holografskih interferograma. Koeficijent prolaska topline  $\alpha$  kretao se u rasponu od 4,6 do 7,4 W/m<sup>2</sup>K. Simulacija prijenosa topline za odabrane uzorke napravljena je uz pomoć Fluent programa. Slijedom toga, vrijednosti izmjerene u istraživanju uspoređene su s izračunanim vrijednostima. Utvrđena je korelacija između izmjerenih i izračunanih vrijednosti.

**Cljučne riječi:** temperaturna polja, bukovo drvo, interferogram, holografska interferometrija, koeficijent prolaska topline

<sup>1</sup> Authors are associate professor, professor and researchers at Technical University in Zvolen, Faculty of Environmental and Manufacturing Technology, Department of Manufacturing and Automation Technology, Zvolen, Slovakia. <sup>2</sup> Author is researcher at Technical University in Zvolen, Faculty of Wood Sciences and Technology, Institute of Foreign Languages, Zvolen, Slovakia.

<sup>1</sup> Autori su izvanredni profesor, profesor i istraživači Tehničkog sveučilišta u Zvolenu, Fakultet za okolišnu i proizvodnu tehnologiju, Zavod za proizvodnju i automatizaciju, Zvolen, Slovačka. <sup>2</sup> Autorica je istraživačica Tehničkog sveučilišta u Zvolenu, Fakultet drvnih znanosti i tehnologije, Institut za strane jezike, Zvolen, Slovačka.

## 1 INTRODUCTION

### 1. UVOD

The topic of heat transfer by wood has been investigated for many years; however, it is still very current because its investigation can still widen the existing knowledge that can be used to observe heat leakage in wooden constructions, heat absorption for the detection of deformations and flaws, especially on the violin belly during production; to observe heat transfer in the floor heating, to verify fire and technical properties of wood, processes of its ignition, burning and thermic decomposition. Observation of temperature fields during wood heating widens the possibilities of wood utilisation beside its normal acoustic and aesthetic properties in the area of thermal insulation in the interiors and households.

The topic of heat transfer has been elaborated by many authors. Oumarou *et al.* (2014) studied the heat transfer in a numerical manner during thermal processing of wood at a high temperature. They also investigated 3D modelling of conjugated heat and mass transfer. Simo-Tagne *et al.* (2016) modelled heat and mass transfer during tropical wood drying. Kazi *et al.* (2015) calculated the heat transfer coefficient of liquid phloem pulp to monitor the quality of phloem and paper. They found out that the heat transfer was influenced by various properties of fibre such as fibre length, fibre flexibility, chemical and mechanical processing, variations of the fibre by different parts of a tree, as well as different methods used to produce cellulose. Kadem *et al.* (2011) modelled heat and mass transfer during thermal treatment of wood. They designed the simulation enabling the assessment of heat and mass transfer impact for the wood and surrounding air and provided a good insight into the complexity of transfer mechanisms. Zhang *et al.* (2013) experimentally investigated heat transfer mechanisms at flame spread along a horizontal surface of building materials (wood and extruded polystyrene surfaces). Duffy *et al.* (2011) calculated the characteristics of heat transfer and pressure loss for suspension of synthetic and cellulose fibres in an annular flow. Younsi *et al.* (2007) performed computer modelling of heat and mass transfer during high-temperature wood processing. Seoa *et al.* (2014) compared the heat transfer characteristics of wooden floorings according to their installations. Karabay *et al.* (2013) numerically investigated the flow and heat transfer inside a room for floor heating and wall heating. Liu *et al.* (2017) investigated the wood materials used for floor heating, Ding *et al.* (2016) investigated thermal degradation of beech wood, Deliiski *et al.* (2016) investigated modelling and energy consumption for heating, and Sinković *et al.* (2011) compared the physical properties of untreated and heat-treated beech. Many authors (Pavelek *et al.*, 2009; Černecký *et al.*, 2014; Sfarra *et al.*, 2017) investigated the temperature fields by holographic interferometry.

In our research, the temperature fields above heated samples were observed. The aim was to obtain new information about wood properties, especially

time dependencies, continuous change of temperature field and complete picture of a temperature field. The holographic interferometry should be used in visualizing temperature fields, enabling us to visualize temperature fields contact-free and to observe processes occurring in the thermal boundary layer in the interface of wood and surroundings.

## 2 MATERIALS AND METHODS

### 2. MATERIJALI I METODE

#### 2.1 Visualization and analysis of temperature fields

##### 2.1. Vizualizacija i analiza temperaturnih polja

The investigated processes during transfer are so complex that their mathematical analysis is possible only after several simplifications. Even though the sets of differential equations are achieved, they cannot be solved exactly in many cases. The transfer characteristics during thermal loading of wood are difficult to find mathematically; hence, they are often substituted by coefficients and criterion-based dependencies. Considering the complexity of the theoretical solution of the transfer phenomena by mathematical and modelling methods, it is always necessary to provide the prerequisite simplifications. The optic methods enable progress in solving the mentioned issues.

One of the possible applications of holographic interferometry is the visualization of temperature distribution above the sample body during observation of thermal loading of wood in different anatomic directions possibly for other sample bodies based on wood. The interference method enables to assess the observed phenomena in a quantitative way; moreover, it provides a complex picture of size and shape of thermal fields in the particular time while the measured values are not influenced by the reader. Another advantage of the method is the possibility to record a complete course from the beginning of heating of the sample to its ignition or flaming.

As most of the observed thermal fields are transparent environments, they are invisible to the human eye. It is necessary to change some physical parameters, such as temperature, to be able to observe these transparent substances. The thermal field above the sample body represents optical non-homogeneity. At the constant pressure, the relative gas density changes directly proportional to temperature changes. As the refractive index in an environment is the function of its density, the processes connected with the changes of temperature are characterized by the change of the refractive index.

The interference method is based on the identification of light wave phase change. The phase change determines the changes of refractive index. The environment with the higher temperature than the surroundings (reference environment) has a different density compared to it and therefore it also has a different refractive index. The determination of the refractive index in different places in the environment enables to state its density and, thereafter, its temperature.

The formula (1) (Pavelek and Štětina, 1997; Brodnianská and Pivarčiova, 2018) was used to calculate the final functional dependence of temperature on parameters of the ambient environment, sample body length, wavelength (it is included in the constant) and on the number of dark fringes from the place of the homogenous environment:

$$T(x, y) = \frac{T_\infty}{1 - 0.805 \cdot \frac{T_\infty}{l \cdot p_\infty} \cdot \left(s - \frac{1}{2}\right)} \quad (1)$$

Where

$T(x, y)$  – temperature distribution (K),  
 $T_\infty$  – air temperature in the reference area (K),  
 $p_\infty$  – pressure in the given space (Pa),  
 $s$  – order of interference (–),  
 $l$  – model length, along which laser rays verge (m).

Figure 1a shows a square cut through individual isotherms in a specified distance  $x$ , where the values of temperatures  $T(x, y)$  are calculated according to the relation.

An example of the assessment of the temperature profile above heated body is shown in Figure 1b, where the detailed cut-out of the holographic interferogram can be seen. The interferogram shows interference fringes position and distribution of interference orders of the particular cut-out, which transfers the individual colours into the black and white scale. 0 refers to black colour, 255 refers to white colour and then there are the shades of grey. The cut enables specifying the middle position of interference fringes denoted by  $y$  axis, while  $s$  relates to interference orders (Figure 1b).

In the analysis, the calculation of heat transfer from the temperature derivations was used. The value of the local coefficient of heat transfer  $\alpha_x$  depends on many factors, such as flow velocity, surface form, position of the sample body and temperature difference between the surface and the ambient environment. The typical shape of the temperature profile in a thermal boundary layer with the local thickness  $\delta_x$  and local temperature on the sample surface  $T_x$  higher than the temperature of the surrounds  $T_\infty$  is illustrated in Figure 2.

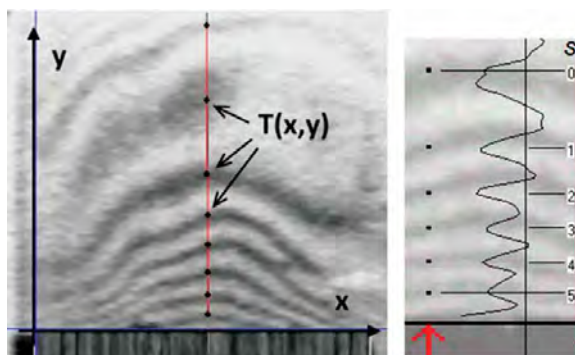

**Figure 1** a) Orientation of axes  $x$  and  $y$  in a recorded interferogram, b) Defining the positions of interference fringes minima and distribution of interference orders  $s$   
**Slika 1.** a) Orijehtacija osi  $x$  i  $y$  u snimljenom interferogramu, b) definiranje položaja najmanjih rubova interferencije i raspodjele interferencijskih naloga  $s$

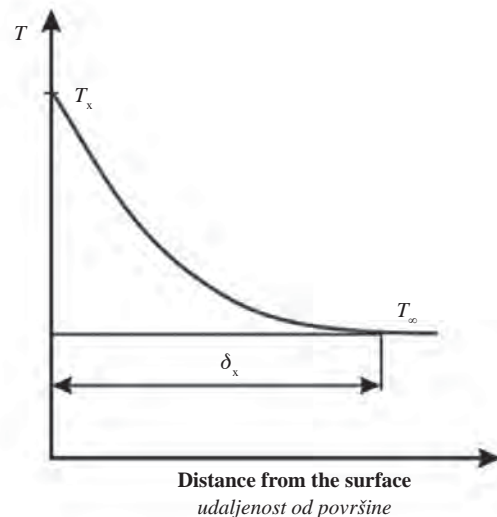

**Figure 2** Temperature profile ( $\delta_x$  – local thickness of thermal boundary layer,  $T_x$  – local temperature on sample surface,  $T_\infty$  – temperature of the surrounding)

**Slika 2.** Temperaturni profil ( $\delta_x$  – lokalna debljina toplinskoga rubnog sloja,  $T_x$  – lokalna temperatura na površini uzorka,  $T_\infty$  – temperatura okoline)

The local coefficient of heat transfer can be expressed by the equation (Brodnianská and Pivarčiova, 2018):

$$\alpha_x = -\lambda_t \left( \frac{dT}{dy} \right)_x \frac{1}{T_x - T_\infty} \quad (2)$$

Where

$\alpha_x$  – local coefficient of heat transfer (W/m<sup>2</sup>K),  
 $\lambda_t$  – coefficient of heat conductivity of the air (W/mK),  
 $T_x$  – area temperature of the local point  $x$  (K),  
 $T_\infty$  – temperature of the surroundings (K),  
 $dT/dy$  – temperature derivation.

## 2.2 Experimental set-up

### 2.2. Postavljanje eksperimenta

To measure the heat transfer in three basic anatomic directions (radial, tangential, longitudinal), sample bodies of beech were used in the dimensions of 43 mm × 40 mm × 10 mm. Considering the aim of the experiment, which was to monitor the heat transfer and not the thermal degradation, two electric infra-red board heating devices of the total power input of 300 W with the option of manual adjustment of the heat output ranging from 15–100 % were used as the heat source. The output restriction was adjusted to 75 %. The distance of the infra-red heating devices from the shield AI with a square opening of 20 mm × 20 mm was 100 mm. The distance of the sample S from the shield was 18 mm (Figure 3).

Holographic interferograms of temperature field above the heated sample body were recorded at the temperature of the surrounding 298 K (25 °C) and pressure of 98 100 Pa. Holograms were recorded when Mach-Zehnder interferometer was set up for the infinite width of interference fringes in the real time. During the experiment, the distribution of temperature field above the heated sample was recorded after the time periods set in advance (3 minutes, 7 minutes, 15

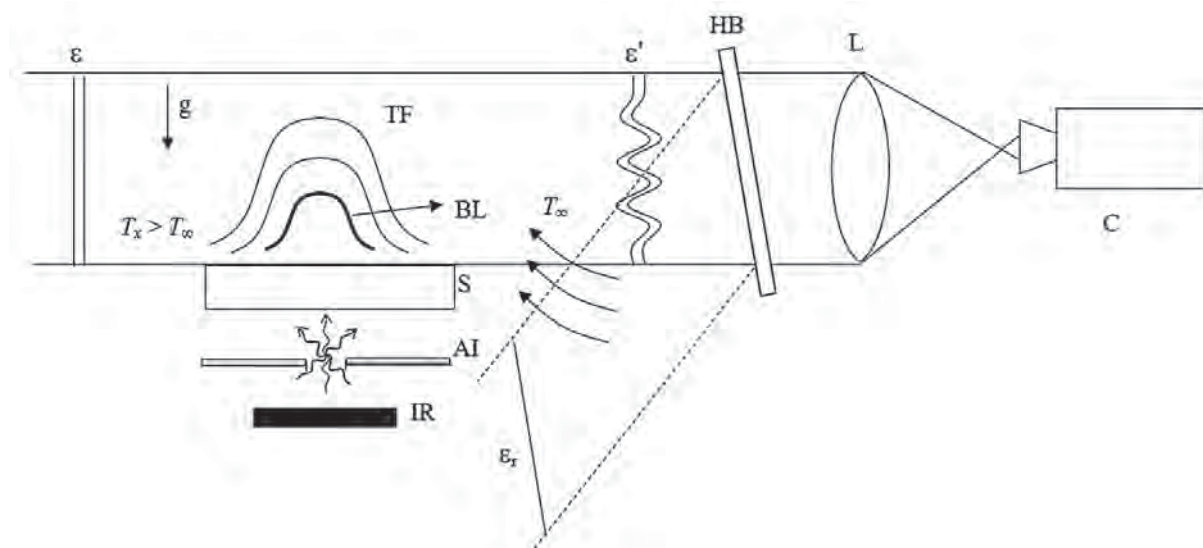

**Figure 3** Heating up the sample body – Experiment scheme (TF – thermal field, BL – boundary layer, S – sample, AI – aperture with insulation, IR – infrared radiator,  $\epsilon$  – wavelength,  $\epsilon'$  – light wave after the transfer through the thermal field,  $e_r$  – reference light wave, HB – holographic board, L – lens, C – camera,  $g$  – gravitational acceleration,  $T_x$  – local temperature on the sample surface at the point  $x$ ,  $T_\infty$  – surrounding temperature)

**Slika 3.** Zagrijavanje uzorka – shema eksperimenta (TF – termalno polje, BL – granični sloj, S – uzorak, AI – otvor s izolacijom, IR – infracrveni radijator,  $\epsilon$  – valna duljina,  $\epsilon'$  – svjetlosni val nakon prijenosa kroz termalno polje,  $e_r$  – referentni svjetlosni val, HB – holografična ploča, L – leća, C – kamera,  $g$  – gravitacijsko ubrzanje,  $T_x$  – lokalna temperatura na površini uzorka, na mjestu  $x$ ,  $T_\infty$  – temperatura okoline)

minutes and or earlier if degradation occurred). During the experiment, the area above the upper side of the sample body was observed because that expresses the best three kinds of heat (convection, radiation, and conduction), thermal and physical properties of the sample body and meanwhile its resistance to destruction.

### 3 RESULTS AND DISCUSSION 3. REZULTATI I RASPRAVA

The method of holographic interferometry in the real time was used to observe temperature fields above the sample bodies from beech wood in three different directions (longitudinal, tangential and radial). The method enabled the presentation of a complete concept and illustration of the size and shape of the temperature field in the particular time via the recorded field of the refractory index of the examined environment, which consequently enabled the analysis and interpretation of the observed phenomenon. The method did not require the entry of the mechanical recorder or scanner into the measured space. Another advantage of the method is the possibility to record a complete time change from the beginning of heating till the ignition.

The course of the experiment was of a dynamic character; individual images changed rather quickly. When the sample bodies are loaded, the heat transfer occurs; the thermal boundary layer appears in close proximity above the heated sample, where interference fringes might be observed.

Quantitative analysis of holographic interferograms images depicts the shape of the temperature fields above the heated sample and mutual influencing







of cold and hot air. Interferometry enabled recording of a complete temperature field in the monitored area and recording of instant processes and development of the boundary layer. The demonstration of holographic interferograms of temperature fields above the heated sample is given in Figure 4.

The images show a steady increase in the width of the boundary layer. In the more distant area from the sample body, the chaotic distribution of interference fringes caused by mixing of cold and warm air occurs. The interference fringes represent the isothermal curves of the temperature field. The images show the individual interference fringes, which are clearly defined due to the change in the refractory index. It is caused by the fact that the sample body is also gradually heated on the top side. The higher the surface temperature is, the more fringes occur. It is possible to calculate the temperatures for the individual fringes.

At the images of temperature fields, the development of the thermal boundary layer, which gradually widens in the vertical direction above the surface of the tested sample, can be observed. Widening of the boundary layer is caused by decreasing the temperature gradient on the surface and decreasing of the heat transfer parameters. The interaction of cold and warm air can also be seen in the images (Figure 6). The possibility to observe the mutual interaction of the thermal boundary layers is a considerable advantage of the holographic interferometry.

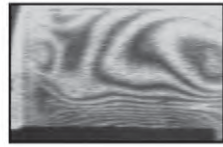
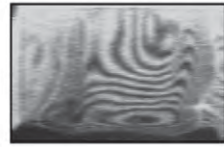
During experiments, it was possible to observe the formation of sequences of typical shapes of interference fringes. Individual types are shown in Figure 5.

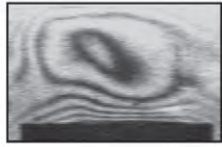
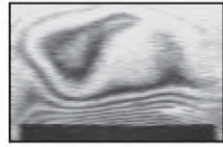
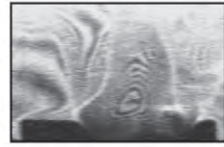
Holograms with closed curves are not usable for assessments (Figure 5g), which were recorded immedi-

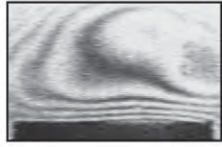
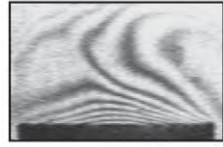
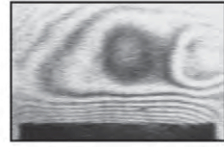
Beech <i>Bukovina</i>	Before experiment (without heating) <i>Prije eksperimenta (bez zagrijavanja)</i>	During experiment (start of heating – 3 min) <i>Tijekom eksperimenta (početak zagrijavanja, 3 min)</i>	During experiment (heating – 7 min) <i>Tijekom eksperimenta (zagrijavanje, 7 min)</i>	End of experiment (glowing combustion or burnt through – 8, 10, 15 min) <i>Kraj eksperimenta (užareno izgaranje ili izgaranje, 8, 10, 15 min)</i>
Longitudinal direction <i>Longitudinalni smjer</i>				
Radial direction <i>Radijalni smjer</i>				
Tangential direction <i>Tangencijalni smjer</i>				

**Figure 4** Holographic interferograms of temperature fields for horizontal wood sample – beech recorded by interferometer set for an infinite width of fringes

**Slika 4.** Holografski interferogrami temperaturnih polja vodoravnog uzorka drva – bukovina zabilježena interferometrom za beskonačnu širinu rubova

ately before the sample burned through. The images that were formed are rather complicated; they contain closed curves and there are too thick interference fringes in the holograms that are impossible to assess quantitatively.

Holograms with the chimney effect gained after burning through were equally impossible to assess (Figure 5h). The temperature field has its characteristic shape given by the escaping combustible gases and hot exhaust gases that spread into sides closely above the sample surface. It can be seen that originally almost horizontal shape of fringes changes into vertical. The fringes have almost a parallel course, especially in the upper part.

During the experiment, it was found that temperatures tend to change under the influence of the disturbances of the ambient environment. The temperature difference was small and changed its position impacted by fluxes of cold air. The values closely above the sample surface are the most objective; the bigger the distance from the sample surface, the stronger is the impact of the surrounding.

Considering the fact that the experiments were performed in a common laboratory, the images show that the shape of interference fringes is influenced by surrounding conditions in the laboratory such as:

- Local natural convection in the measured space above the sample body, caused by mixing warmer air that comes from the sample body and colder air that exists in the surrounding environment, occurs at a certain distance above the sample bodies where the temperature gradient is lower. This caused the formation of bubbles (Figure 5d). Closely above the sample, there was a big temperature gradient. In places

where the temperature gradient decreased, a bubble was formed. During observation, there was opening and closing of the bubble, which was caused by natural convection. The initial stage before a bubble was called “tongues” (Figure 5c)

- Figure 5f shows recorded air convection in the laboratory – in places where the experiments were performed, it was warmer than in the more distant places
- Natural convection occurred during the heating of samples. Cold and warm air mixed and the warm air was pushed upward (Figure 5e), which caused the disturbance in the regular shape of interference image (Figure 5e). It is possible to observe two areas in the holograms (Figure 6): the area of the cold air impact, where it is impossible to assess the interference order, and the area for the quantitative analysis, where the interference order can be identified.
- In the area close to the place of ignition, shortly before burning through, the interference fringes, which cannot be used to assess the temperature, appeared. These holograms do not fit into the system of assessment and cannot be assessed. (Figure 5g, h).

Quantitative analysis of the recorded images of the holographic interferograms is a time consuming and expertise-based process. To manage this work effectively, specialised software, designed at our workplace, was used. The programme enables to calculate the temperatures for individual orders using Eq. 1. Meanwhile, algorithms are also implemented to calculate the values of coefficients of heat transfer  $\alpha$  according to Eq. 2.

Observing the holograms, it was found out that in most cases it is not clear where the highest temperature



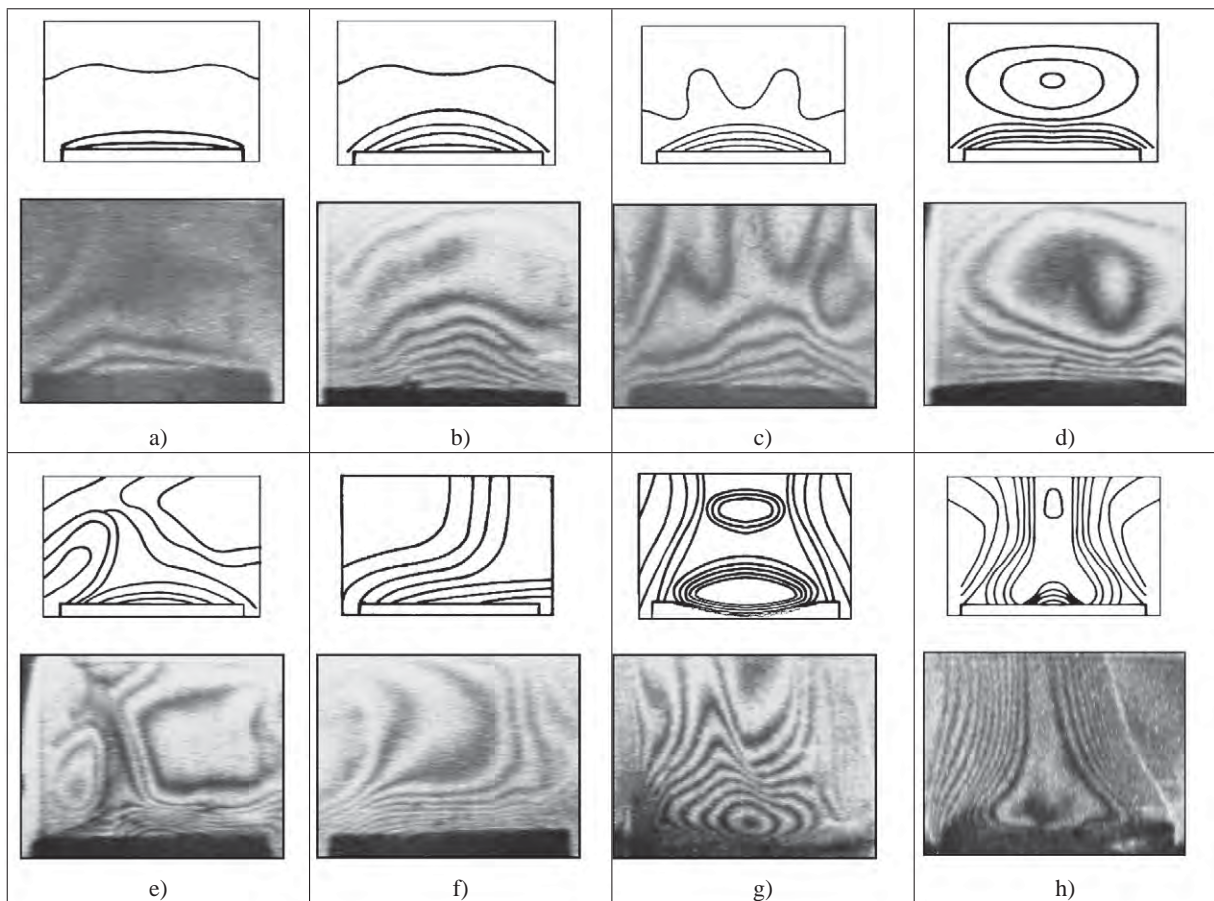

**Figure 5** Typical shapes of temperature fields during heating of wooden samples: a) a small number of interference fringes – the start of heating, b) a bigger number of interference fringes – heating, c) tongues – initial state before a bubble, d) bubbles – an influence of the local natural convection above the sample, e) additional interference fringes – not keeping the dimensions of the sample body, f) waves – the influence of convection, g) complicated images with closed curves – immediately before burning through a sample, h) a chimney – after burning through the sample

**Slika 5.** Tipični oblici temperaturnih polja tijekom zagrijavanja uzoraka drva: a) mali broj interferencijskih granica – početak zagrijavanja, b) veći broj interferencijskih granica – zagrijavanje, c) jezici – početno stanje prije mjehurića, d) mjehurići – utjecaj lokalne prirodne konvekcije iznad uzorka, e) dodatne granice interferencije – bez zadržavanja dimenzija tijela uzorka, f) valovi – utjecaj konvekcije, g) komplicirane slike sa zatvorenim zavojima – neposredno prije izgaranja kroz uzorak, h) dimnjak – nakon izgaranja kroz uzorak

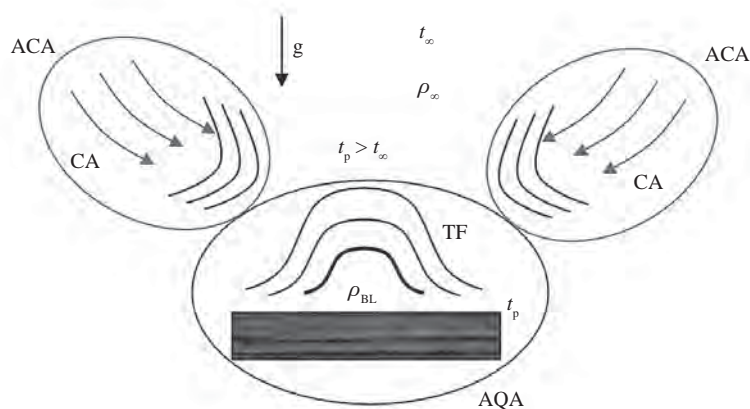

**Figure 6** Airflow above sample (TF – temperature field, BL – boundary layer,  $g$  – gravitation acceleration,  $t_p$  – sample surface temperature,  $t_\infty$  – surrounding air temperature,  $\rho_{BL}$  density of the boundary layer,  $\rho_\infty$  – density of the surrounding air, CA – ambient cold air flow, AQA – the area for the quantitative analysis, ACA – the area of the cold air impact)

**Slika 6.** Protok zraka iznad uzorka (TF – temperaturno polje, BL – granični sloj,  $g$  – gravitacijsko ubrzanje,  $t_p$  – temperatura površine uzorka,  $t_\infty$  – temperatura okolnog zraka,  $\rho_{BL}$  gustoća graničnog sloja,  $\rho_\infty$  – gustoća okolnog zraka, CA – protok hladnog zraka, AQA – područje za kvantitativnu analizu, ACA – područje utjecaja hladnog zraka)

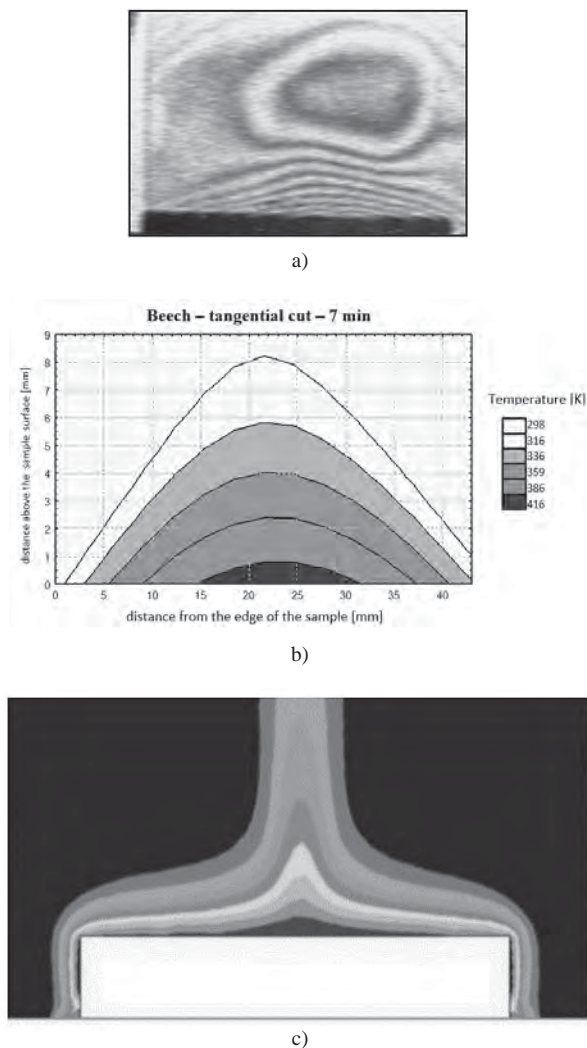

**Figure 7** Temperature fields above the heated sample: a) Experimental holographic interferogram, b) Analytical illustration of the temperature calculated by Eq. 1 depending on distance above the sample and from the edge of the sample, c) CFD simulation

**Slika 7.** Temperaturna polja iznad zagrijanog uzorka: a) eksperimentalni holografski interferogram, b) analitički prikaz temperature izračunane prema formuli (1) u ovisnosti o udaljenosti od površine i ruba uzorka, c) CFD simulacija

is because the number of fringes is the same in the centre and at the edges of the sample, which means that the temperatures are the same but at different distances above the sample body. This is caused by the fact that the dimensions of the sample were rather small, and the temperature spread across the complete surface of the sample body. The heat transfer was influenced by the wood species structure (e.g. density), dimensions of the sample body, and ambient surrounding impacts.

CFD simulation of heat transfer was conducted by the commercial programme Fluent to enable the comparison of the temperature fields from the holographic interferograms achieved by the experiment.

Figure 7 shows the change of the temperature fields above the heated sample. The temperatures of the isothermal curves (Figure 7a) were expressed by the quantitative analysis of holographic interferograms by Eq. 1. Figure 7b shows the graph illustrating the tem-

perature change depending on the distance and position on the sample body. Figure 7c shows simulation of the temperature field via Fluent programme.

The values of interference orders  $s$  and the distances corresponding to individual interference orders were determined by the analysis of holographic interferograms with a great emphasis on the accuracy of reading interference fringes. To calculate  $T$  temperature, Eq. 1 was used and the entered input parameters were: temperature of the surrounding  $T_{\infty} = 25^{\circ}\text{C}$  (298 K), pressure of the surrounding  $p_{\infty} = 98100$  Pa, the ordinal number of the interference order  $s = 0, 1, \dots$  (Figure 1b), sample length  $l = 0.043$  m. Further processing was carried out by Statistica program and the graphical illustration of the temperature progress depending on the height  $y$  above the sample and distance  $x$  from the edge of the sample (Figure 7b). The identical geometrical and boundary conditions: the temperature of the surrounding  $25^{\circ}\text{C}$  (298 K) and pressure of 98100 Pa were used for the CFD simulation (Figure 7c) by the program Fluent and in the experiment.

The calculation network (of the triangle elementary type) was generated with the optimum number of calculation points. The simulation analyses for boundary conditions were performed as follows: The viscosity model was chosen „laminar“, the density of the air was calculated for the ideal gas. The interface fringes above the heated sample correlate with the outline of the temperature fields achieved by simulation. Figure 8 shows the three-dimensional graphs of the analytical illustration of the dependence of temperature, direction, and distance above the sample.

Figure 8 shows that the highest temperature during heating the sample in the longitudinal direction was 493 K at 1.3 mm above the sample, in the radial direction the highest temperature was 450 K at 0.3 mm and

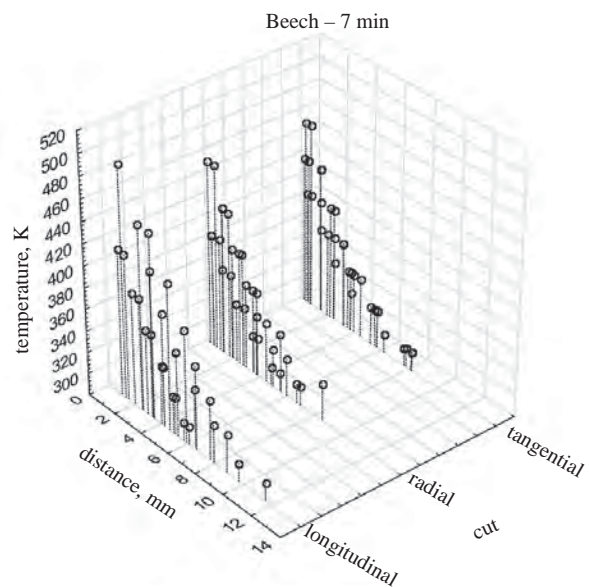

**Figure 8** Analytical illustration of the temperature calculated by Eq. 1 depending on direction and distance above the sample

**Slika 8.** Analitička ilustracija temperature izračunane prema formuli (1) u ovisnosti o smjeru i udaljenosti od površine uzorka

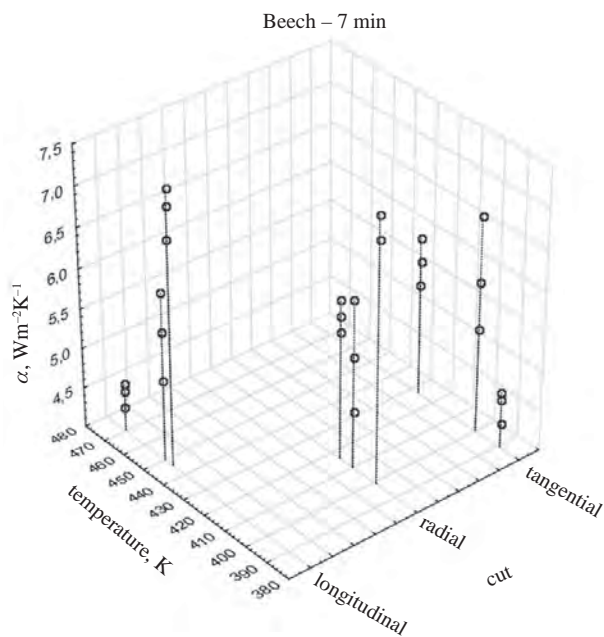

**Figure 9** Heat transfer coefficient  $\alpha$  calculated by Eq. 2 depending on temperature calculated by Eq. 1 and direction **Slika 9.** Koeficient prijenosa toplote  $\alpha$  izračunan prema formuli (2) u ovisnosti o temperaturi izračunanoj prema formuli (1) i smjeru

in the tangential direction it was 450 K at 0.4 mm. Figure 9 shows the graphically illustrated local coefficient of heat transfer  $\alpha$  calculated from the holographic interferograms according to Eq. 2. For example to calculate the local heat transfer coefficient  $\alpha = 5.72 \text{ W/m}^2\text{K}$ , the following input values were used: table value of the heat conductivity coefficient for the air on the sample body surface  $\lambda_t = 0.02854$  at temperature  $T_x = 342 \text{ K}$  of the surface at the local point  $x = 10 \text{ mm}$ , calculated by Eq. 1, at surrounding temperature  $T_\infty = 298 \text{ K}$ . Temperature derivation  $dT/dy = -8816.51$  was entered as the ratio of temperature differences (359 – 386 K) and distances of two interference fringes (3 mm) at the point  $x$  above the sample surface.

Figure 9 shows that the values of the heat transfer coefficients  $\alpha$  within the range of 4.6 – 7.4  $\text{W/m}^2\text{K}$ . Heat transfer in woods is influenced by a number of factors, the most influential being presented by the anatomic structure of the wood, density and moisture content of wood. Scattering of the calculated values of heat transfer coefficient  $\alpha$  also depends on the method of measuring and outer conditions during the individual measurements.

#### 4 CONCLUSIONS

#### 4. ZAKLJUČAK

Within the experiment, the temperature fields during thermal loading of beech samples in various time intervals and various distances from the surface were visualized. The data on temperature fields during thermal loading of beech samples were obtained. At the same time, the information was obtained about wood behaviour in the process of thermal loading in

dependence on temperature and temperature gradients which can be recorded by interferometric methods. The various shapes of interference fringes typical for the thermal loading of wood were recorded.

The local coefficients of heat transfer  $\alpha$  for three directions were calculated from the holographic images. The recorded and assessed data resulted in the value of heat transfer coefficient  $\alpha$  which ranged within 4.6 – 7.4  $\text{W/m}^2\text{K}$ .

Using holographic interferometry, the method for calculating the heat transfer coefficient  $\alpha$  was found. Further investigation is required to polish up the method of determination of the temperature derivation on the sample/body surface, which will enable stating the  $\alpha$  coefficient more precisely; e.g. to substitute the temperature progress in the boundary layer by a mathematical procedure.

In our research, the temperature field was observed as a whole, rather than local changes that can be measured by thermo-couples. That enabled us to record a dynamic process – heat exchange above the samples, which can be used aptly e.g. to choose the material suitable for floor heating.

Further research may focus on temperature fields from the samples of other wood-based materials (such as chipboard, plywood), samples with wood joints, samples with treated surface, samples with flame retardant treatment, the use of radiant heat, etc.

#### Acknowledgements – Zahvala

The paper was elaborated with the support of the Ministry of Education, Science, Research and Sports of the Slovak Republic within grant project VEGA 1/0315/17: Research of applicable properties of thermally modified wood in interaction phenomena of matching process with optimal surface prediction and VEGA 1/0086/18: Researching temperature fields in a set of shaped heat transfer surfaces.

#### 5 REFERENCES

#### 5. LITERATURA

1. Brodnianská, Z.; Pivarčiová, E., 2018: Heat and Mass Transfer (in Slovak). Publisher of Technical University in Zvolen, 2018., 255 p.
2. Cernecky, J.; Koniar, J.; Brodnianska, Z., 2014: The effect of heat transfer area roughness on heat transfer enhancement by forced convection. *Journal of Heat Transfer*, 136 (4): 4025920. doi: 10.1115/1.4025920.
3. Deliiski, N.; Trichkov, N.; Angelski, D.; Dzurenda, L., 2016: Modeling and Energy Consumption of Unilateral Heating Process of Flat Wood Details. *Drvna industrija*, 67 (4): 381-391. <https://doi.org/10.5552/drind.2016.1518>.
4. Ding, Z.; Ezekoye, O. A.; Lu, S.; Wang, Ch., 2016: Thermal degradation of beech wood with thermogravimetry / Fourier transform infrared analysis. *Energy Conversion and Management*, 120: 370-377. <https://doi.org/10.1016/j.enconman.2016.05.007>.
5. Duffy, G. G.; Kazi, S. N.; Chen, X. D., 2011: Heat transfer and pressure drop characteristics of suspensions of synthetic and wood pulp fibres in annular flow. *Applied Thermal Engineering*, 31 (14.15): 2971.2980. <https://doi.org/10.1016/j.applthermaleng.2011.05.028>.

6. Kadem, S.; Lachemet, A.; Younsi, R.; Kocaefe, D., 2011: 3D-Transient modeling of heat and mass transfer during heat treatment of wood. *International Communications in Heat and Mass Transfer*, 38 (6): 717-722. <https://doi.org/10.1016/j.icheatmasstransfer.2011.03.026>.
7. Karabay, H.; Arıcı, M.; Sandık, M., 2013: A numerical investigation of fluid flow and heat transfer inside a room for floor heating and wall heating systems. *Energy and Buildings*, 67: 471-478. <https://doi.org/10.1016/j.enbuild.2013.08.037>.
8. Kazi, S. N.; Duffy, G. G.; Chen, X. D., 2015: Heat transfer coefficient of flowing wood pulp fibre suspensions to monitor fibre and paper quality. *Applied Thermal Engineering*, 78: 172-184. <https://doi.org/10.1016/j.applthermaleng.2014.11.072>.
9. Liu, C.; Luo, R.; Zhou, S.; Du, G., 2017: The Construction of Heat Storage Performance Testing Method of Wood Materials used for Floor Heating. *Procedia Engineering*, 205: 3804-3810. <https://doi.org/10.1016/j.proeng.2017.10.116>.
10. Oumarou, N.; Kocaefe, D.; Kocaefe, Z., 2014: 3D-modelling of conjugate heat and mass transfers: Effects of storage conditions and species on wood high temperature treatment. *International Journal of Heat and Mass Transfer*, 79: 945-953. <https://doi.org/10.1016/j.ijheatmasstransfer.2014.08.086>.
11. Pavelek, M.; Janotková, E.; Pavelek, T., 2009: Applying interferometry in researching convection heat transfer from panel radiators. *Journal of Flow Visualization and Image Processing*, 16 (2): 159-181. <https://doi.org/10.1615/JFlowVisImageProc.v16.i2.40>.
12. Pavelek, M.; Štětina, J., 1997: Experimentální metody v technice prostředí. VUT Brno, 215 p.
13. Seo, J.; Parka, Z.; Kima, J.; Kima, S.; Kimc, J. T., 2014: Comparison of thermal transfer characteristics of wood flooring according to the installation method. *Energy and Buildings*, 70: 422-426. <https://doi.org/10.1016/j.enbuild.2013.11.085>.
14. Sfarra, S.; Theodorakeas, P.; Cernecky, J.; Pivarčiová, E.; Perilli, S.; Koui, M., 2017: Inspecting Marquetries at Different Wavelengths: The Preliminary Numerical Approach as Aid for a Wide-Range of Non-destructive Tests. *Journal of nondestructive evaluation*, 36 (1): 2-20. <https://doi.org/10.1007/s10921-016-0384-2>.
15. Simo-Tagne, M.; Rémond, R.; Rogaume, Z.; Zoulalian, A.; Bonoma, B., 2016: Modeling of coupled heat and mass transfer during drying of tropical woods. *International Journal of Thermal Sciences*, 109: 299-308. <https://doi.org/10.1016/j.ijthermalsci.2016.06.012>.
16. Sinković, T.; Govorčin, S.; Sedlar, T., 2011: Comparison of Physical Properties of Untreated and Heat Treated Beech and Hornbeam. *Drvna industrija*, 62 (4): 283-290. <https://doi.org/10.5552/drind.2011.1118>.
17. Younsi, R.; Kocaefe, D.; Poncsak, S.; Kocaefe, Y., 2007: Computational modelling of heat and mass transfer during the high-temperature heat treatment of wood. *Applied Thermal Engineering*, 27 (8-9): 1424-1431. <https://doi.org/10.1016/j.applthermaleng.2006.10.025>.
18. Zhang, Y.; Sun, J. H.; Huang, X. J.; Chen, X. F., 2013: Heat transfer mechanisms in horizontal flame spread over wood and extruded polystyrene surfaces. *International Journal of Heat and Mass Transfer*, 61: 28-34. <https://doi.org/10.1016/j.ijheatmasstransfer.2013.01.069>.

#### Corresponding address:

Assoc. Prof. ELENA PIVARČIOVÁ  
Technical University in Zvolen  
Faculty of Environmental and Manufacturing  
Technology  
Department of Manufacturing and Automation  
Technology  
Študentská 26, 960 53 Zvolen, SLOVAKIA  
e-mail: pivarciova@tuzvo.sk



## Laboratorij za ispitivanje namještaja i dijelova za namještaj

**Dobra suradnja s proizvođačima, uvoznicima i  
distributerima namještaja čini nas prepoznatljivima**



akreditirani laboratorij za ispitivanje  
kvalitete namještaja i dijelova za  
namještaj prema HRN EN ISO/IEC 17025

56 akreditiranih metoda u području  
ispitivanja namještaja,  
dječjih igrališta i opreme,  
boja i lakova

ispitivanje materijala i postupaka  
površinske obrade

istraživanje drvnih konstrukcija i  
ergonomije namještaja

ispitivanje zapaljivosti i ekološkiosti  
ojastučenog namještaja

sudska stručna vještačenja

Kvaliteta namještaja se ispituje i istražuje, postavljaju se osnove normi za kvalitetu, razvijaju se metode ispitivanja, a znanost i praksa, ruku pod ruku, kroče naprijed osiguravajući dobar i trajan namještaj s prepoznatljivim oznakama kvalitete. Kvalitete koja je temelj korisniku za izbor namještaja kakav želi. Taj pristup donosi je Laboratoriju za ispitivanje namještaja pri Šumarskom fakultetu međunarodno priznavanje i nacionalno ovlaštenje te članstvo u domaćim i međunarodnim asocijacijama, kao i suradnju s vodećim europskim institutima i laboratorijima.

Laboratorij je član udruge hrvatskih laboratorija CROLAB čiji je cilj udruživanje hrvatskih ispitnih, mjeriteljskih i analitičkih laboratorija u interesu unaprjeđenja sustava kvalitete laboratorija te lakšeg pridruživanja europskom tržištu korištenjem zajedničkih potencijala, dok je Šumarski fakultet punopravni član udruženja INNOVAWOOD kojemu je cilj doprinijeti poslovnim uspjesima u šumarstvu, drvnjoj industriji i industriji namještaja s naglaskom na povećanje konkurentnosti europske industrije.

Istraživanje kreveta i spavanja, istraživanja dječjih krevetića, optimalnih konstrukcija stolova, stolica i korpurnog namještaja, zdravog i udobnog sjedenja u školi, u redu i kod kuće neka su od brojnih istraživanja provedena u Zavodu za namještaj i drvine proizvode, kojima je obogaćena raznica znanja o kvaliteti namještaja.

# Znanje je naš kapital



# The Effect of Chip Size and Alkaline Pre-Hydrolysis Conditions on Following Soda Pulping of Hornbeam Wood

## Utjecaj veličine sječke i uvjeta alkalne predhidrolize na natronski postupak proizvodnje celuloze od grabovine

### Original scientific paper • Izvorni znanstveni rad

Received – prispjelo: 11. 7. 2018.

Accepted – prihvaćeno: 20. 11. 2019.

UDK: 630\*813.13; 630\*813.14; 630\*861.02; 630\*862.21

<https://doi.org/10.5552/drvind.2019.1832>

**ABSTRACT** • *The impact of chip size and hydrolysis temperature on changing chemical composition of hornbeam wood and following soda pulping is investigated. Three chip sizes, two temperatures (60 and 90 °C) and 120 minutes retention time in pre-hydrolysis step were selected. After pre-hydrolysis treatment, the sample was divided into two portions; one third was used for chemical analysis and the other two thirds for soda pulping. The reference soda pulping conditions were used on either treated or untreated chips. The influence of pre-hydrolysis was determined measuring cellulose and lignin content, residual alkali and the hemicelluloses removal. The lignin and cellulose content were marginally increased and the hemicellulose removal was higher at larger chip size. Total yield and rejects, kappa number and strength properties of the unbleached pulp were measured using corresponding Tappi standard test methods. The pulping total yield and rejects of the treated chips varied between 30.31 % and 48.14 % and 0.83 % to 7.31 %, respectively. The reject from soda pulping of untreated chips was 24.16. Pre-hydrolysis treatment reduced the tensile index, but the tear index was only marginally improved.*

**Keywords:** hemicelluloses, pre-hydrolysis, yield, strength, residual alkali, hornbeam, soda pulping

**SAŽETAK** • *U radu je istražen utjecaj veličine sječke i temperature hidrolize na promjene kemijskog sastava grabovine te naknadni natronski proces proizvodnje celuloze. Za predhidrolizu su odabrane tri veličine sječke, dvije temperature (60 i 90 °C) i retencijsko vrijeme od 120 minuta. Uzorak je nakon predhidrolize podijeljen na dva dijela, pri čemu je jedna trećina iskorištena za kemijsku analizu, a ostale su dvije trećine upotrijebljene za natronski postupak proizvodnje celuloze. Referentni uvjeti natronskog postupka primijenjeni su na predretiranoj i netretiranoj sječki. Utjecaj predhidrolize određen je mjerenjem sadržaja celuloze i lignina, količine zaostale lužine i izdvajanja hemiceluloza. Sadržaj celuloze i lignina samo je neznatno porastao, dok je izdvajanje hemiceluloza bilo veće za sječku većih dimenzija. Ukupan prinos vlakana i udio neadekvatnih vlakana, kappa broj i čvrstoća nebijeljene natronske celuloze određeni su u skladu s odgovarajućim Tappi standardima. Ukupan prinos vlakana i*

<sup>1</sup> Authors are professor, researcher and associate professors at Karaj Branch, Islamic Azad University, Department of Wood and Paper Science and Technology, Karaj, Iran

<sup>1</sup> Autori su profesor, istraživač i izvanredni profesori Islamskog sveučilišta Azad, Podružnica Karaj, Zavod za znanost i tehnologiju drva i papira, Karaj, Iran.

udio neadekvatnih vlakana za netretiranu su drvnu sječku iznosili 30,31 i 48,14 %, odnosno 0,83 do 7,31 %. Udio neadekvatnih vlakana dobivenih natronskim postupkom netretirane sječke iznosio je 24,16 %. Predhidrolizom je smanjen vlažni indeks, uz neznatno poboljšanje indeksa kidanja.

**Ključne riječi:** hemiceluloze, predhidroliza, prinos, čvrstoća, zaostala lužina, grabovina, natronski postupak proizvodnje celuloze

## 1 INTRODUCTION

### 1. UVOD

Chemical industry and energy sector of the world are suffering from increasing consumption and limited supply, because they are almost fully relying on non-renewable oil and natural gas resources. Therefore, this sector is continuously searching for alternative sources of feedstock, and among them lignocellulosic material as renewable sources with low cost and potential volume has been a viable alternative introducing biorefinery concept (Zhang *et al.*, 2015).

Biorefinery concept is considered as a path to sustainability for partial fulfillment of the future demand for chemical feedstock and energy (Hatti-Kaul, 2010). This concept integrates biomass conversion processes to produce fuel, power, and value added chemical from biomass. It is analogous to today's petroleum refining, which produces multiple fuels and products from petroleum (Vachalova *et al.*, 2014).

Pulping residual utilization as chemical production feedstock has been followed by two paths: 1- conversion of residual lignin and hydrolyzed carbohydrates from spent liquor (black liquor) prior to burning the spent liquor, and 2- pre-hydrolysis and extraction of hydrolysate before pulping. The first path has been used for a long period in the production of sugars, vanillin and other derivatives from soft wood pulping liquors. However, the second path is new and has been pursued very extensively during last two decades following the biorefinery concept or forest biorefinery (Ormsby *et al.*, 2012).

Available literature presents information on acid and alkaline per-hydrolysis of different lignocellulosic material to extract carbohydrate hydrolysate to be used as chemical feedstock and also facilitate following pulping reactions. Some of the research works are directed to extract hydrolysate for enzymatic bio-conversion in biofuel and bio-chemical production (Ormsby *et al.*, 2012; Carvalherio *et al.*, 2008; Shen *et al.*, 2018; Liu *et al.*, 2018; Lu *et al.*, 2017; Travaini *et al.*, 2016; Dawan *et al.*, 2008; Song *et al.*, 2011). Kurian *et al.* (2010) enzymatically fermented the xylose and other hemicellulose products from sweet corn in the production of bio-ethanol. Teherzadeh and Karimi (2007) reviewed the acid pre-hydrolysis of various lignocellulosic material. Yan *et al.* (2017) used acidic hot water treatment to improve and characterize the value added non-carbohydrate compounds from poplar wood. Mirahmadi *et al.* (2010) applied mild alkaline pre-hydrolysis on spruce and birch wood to extract sugar compounds for the production of both bio-ethanol and bio-gas, while Jiang *et al.* (2017) applied acid and alkali pretreatment on pine wood to enhance the bio-oil

yield. Sugarcane bagasse (Boopathy *et al.*, 2008) and softwood (Gulbrandsin *et al.*, 2017) have been studied for ethanol production.

In another direction, the research work has been concentrated to investigate the effect of alkaline pre-hydrolysis of depithed corn stover on the hemicellulose extraction and the performance of pre-hydrolyzed corn stover in Soda/AQ pulping (Cheng *et al.*, 2010). Kautto *et al.* (2010) investigated the pre-hydrolysis of softwood chips prior to kraft pulping and stated that the kappa number, yield and strength, except tear strength of the pulp, were reduced. Giant bamboo was pre-hydrolyzed before kraft and Soda/AQ pulping to produce value-added byproducts and facilitate pulping reactions (Vena *et al.*, 2010). Further research on the application of alkaline and acid pre-hydrolysis on wood chips and non-wood resources are credited to Li *et al.* (2010), Helmerius *et al.* (2010), Jahan *et al.* (2014), Cheng *et al.* (2010), Garcia *et al.* (2011) and Liu *et al.* (2011). Ayrilmis *et al.* (2017) investigated the effect of chip size on hemicelluloses extraction and the effect on flakeboard properties.

The importance of chemical feedstock production from lignocellulosic material in conjunction with pulping directed this research to investigate the effect of chip size and alkaline pre-hydrolysis temperature on hornbeam wood to extract the carbohydrate hydrolysate and to determine its effect on soda pulping.

## 2 MATERIALS AND METHODS

### 2. MATERIJALI I METODE

#### 2.1 Raw material

##### 2.1. Sirovina

Hornbeam (*Carpinus betulus*) bolt (length 100 cm and diameter 40 cm) was cut from a longer log at a forest harvesting operation yard in Northern Iran and was transferred to Pulp and Paper Research Laboratory, Islamic Azad University, Karaj Branch. First, the bolt was debarked and then converted to narrower long boards using a band saw. The boards were then chipped using a drum chipper (Pallmann Drum Chipper PHT 430X120). The chips were air dried at ambient temperature to reach equilibrium moisture content and were visually classified in three different sizes (Table 1). The selected chips were stored in plastic bags until used.

#### 2.2 Chemical analysis

##### 2.2. Kemijska analiza

Chemical components of untreated and treated chips including cellulose and lignin were measured using the following Tappi test procedures: Powder preparation; T257 cm-20, extractive free powder; T264 cm-07, Lignin; T222 0m-06 (Tappi, 2008), Cellulose content was measured by Kurschner-Hoffer method.

**Table 1** Average dimensions of classified chips

**Tablica 1.** Prosječne dimenzije klasificirane sječke

Chip class <i>Klasa sječke</i>	Dimension <i>Dimenzija</i>	Length, mm <i>Duljina, mm</i>	Width, mm <i>Širina, mm</i>	Thickness, mm <i>Debljina, mm</i>
Small / <i>mala</i>		13.74	7.50	2.10
Medium / <i>srednja</i>		20.40	9.05	3.14
Large / <i>velika</i>		30.86	17.74	4.98

### 2.3 Alkaline pre-hydrolysis

#### 2.3. Alkalna predhidroliza

Alkaline pre-hydrolysis of chips was performed using 7.5 % (w/w) reagent grade sodium hydroxide (Merck, Germany), 120 minutes time and two temperatures (60 and 90 °C). A sample weighing 150 grams (bone dry) was mixed with 1500 milliliter distilled water and 7.5 % (w/w) sodium hydroxide (based on the dry weight of the chips) was added to the mixture in a plastic bag. The bag was sealed and heated in hot water bath at constant temperature with occasional manual shaking to ensure uniformity. At the end of treatment time, the content of the plastic bag was discharged on a screen (200 mesh) and the liquor (filtrate) was collected. This liquor was used to determine residual sodium hydroxide and dissolved hemicelluloses. The per-hydrolyzed chips were divided into two portions: one-third for the determination of chemical composition and the other two-thirds were used for soda pulping experiments.

### 2.4 Hemicelluloses precipitation

#### 2.4. Količina hemiceluloza

The dissolved hemicelluloses were determined as follow. First, the pH of the filtrate was adjusted to 5 using 4N H<sub>2</sub>SO<sub>4</sub> and the solution was kept refrigerated for 24 hours to precipitate the dissolved lignin in the filtrate. Then, after the separation of lignin, 100 milliliters of the hydrolysate was transferred to a 1000 milliliters beaker and 400 milliliters 96 % ethanol was added. The solution was refrigerated for another 24 hours. Thereafter, the solution was centrifuged for 5 minutes at 7500 rpm. The hemicelluloses were separated and dried in an oven set at 40 °C for 24 hours. The weight of the hemicelluloses was determined and the percentage based on original wood was calculated.

### 2.5 Pulping

#### 2.5. Priprema pulpe

Soda pulping was used on per-hydrolyzed chips with and without alkaline pre-hydrolysis. Pulping conditions were kept constant as follow: sodium hydroxide; 20 % based on bone dry weight of chips, cooking temperature and time; 175 °C and 90 minutes after reaching the cooking temperature, wood to liquor ratio: 1:8. Untreated and treated chips were pulped using a 4-liter rotating digester (Ghomes Wood and Paper Equipment Manufacturing Co.). At the end of each pulping time, the content of the cylinder was discharged on a 200 mesh screen, and the spent liquor was collected. The cooked material was defibrated using a

25 cm laboratory single disc refiner (Ghomes Wood and Paper Equipment Manufacturing Co) in three passes and then the pulp was screened using a set of two screens, a 14-mesh screen on top of 200 mesh screens. Material retained on the 14-mesh screen (R14) was considered as reject (shives), and the fibers passed through the 14-mesh screen and retained on the 200-mesh screen (P14-R200) were considered as accept (screened yield), which was added to reject and the total yield was calculated.

The following TAPPI standard test methods were used for pulp and hand sheets evaluation: Kappa number, T236 om-06; Drainage, T227 om-04; Hand sheet preparation, T205 om-06; Tear strength, T414 om-04; and Tensile strength, T494 om-06 (Tappi, 2008).

### 2.6 Statistical analysis

#### 2.6. Statistička analiza

Analysis of variance (ANOVA) was used for statistical analysis of the data and in case the significant difference between the averages was observed, then Duncan Multiple Range Test was used for grouping the averages.

## 3 RESULTS AND DISCUSSION

### 3. REZULTATI I RASPRAVA

#### 3.1 Alkaline pre-hydrolysis

##### 3.1. Alkalna predhidroliza

The results of the cellulose and lignin measurements of treated and untreated hornbeam chips are summarized in Table 2. Each value in Table 2 is the average of three measurements.

Both cellulose and lignin content of treated hornbeam chips is higher than that of the untreated chips, which is due to the removal of hemicelluloses by alkaline treatment.

The results of the statistical analysis on the effect of pre-hydrolysis temperature and chip size on the measured properties are shown in Table 3. The influence of treatment temperature on residual alkali, cellulose content of treated chips and hemicelluloses removal were not statistically significant but the effect of temperature on lignin content of the pre-hydrolyzed chips was statistically significant at 99 % confidence level. However, the effect of chip size on residual alkali was statistically significant at 95 % confidence level and the effect of chip size on cellulose, lignin and hemicelluloses removal was significant at 99 % confidence level. The interactive effect of both variables on residual alkali was not



**Table 2** The average cellulose and lignin content of treated and untreated hornbeam chips

**Tablica 2.** Prosječni sadržaj celuloze i lignina u tretiranoj i netretiranoj sječki grabovine

Variables Varijable		Properties Svojstva	Cellulose Celuloza	Lignin Lignin
		Chip size Veličina sječke	%	%
Temperature, °C Temperatura, °C	60	Small / mala	52.5	19.0
		Medium / srednja	55.5	19.5
		Large / velika	48.0	15.0
90		Small / mala	53.5	18.5
		Medium / srednja	53.0	19.0
		Large / velika	52.5	20.5

significant and the effect on cellulose, lignin and hemicelluloses removal was statistically significant at 99 % and 95% significance level, respectively (Table 3).

The interactive effect of chip size and pre-hydrolysis temperature on hemicelluloses removal is illustrated in Figure 1. The amount of hemicelluloses removed varied between the lowest value of 2.98 % and

the highest value of 7.14 % of the original weight of the wood. Higher amount of hemicelluloses were removed from larger chips, which indicates the penetration of the alkali deep into the chips and removal of more hemicelluloses. The effectiveness of the sodium hydroxide in dissolution and hydrolysis of hemicelluloses is higher at higher treatment temperature, which relates to more severe condition.

The results of hornbeam wood alkaline pre-hydrolysis indicate the potential of this treatment to dissolve and remove the hemicelluloses (Garcia *et al.*, 2011; Helmerius *et al.*, 2010; Li *et al.*, 2011; Ormsby *et al.*, 2012; Carvalherio *et al.*, 2008; Liu *et al.*, 2018; Lu *et al.*, 2017; Song *et al.*, 2011, Vena *et al.*, 2010). Alkaline pretreatment breaks the lignin-carbohydrate bonds and dissolves the hemicelluloses. Figure 2 schematically shows the location of hemicelluloses in cell wall structure and possible lignin-carbohydrate bonding. These hemicelluloses can be a source of carbohydrate as feedstock for bio-ethanol production in biorefinery concept. As shown in Figure 3, the sodium hydroxide charged on the chips is not totally absorbed by the wood and between 2 to 3.8 % remained indicating the sufficiency of the alkali charge for the treatment condition applied. The absorption of the sodium hydroxide at lower tempera-

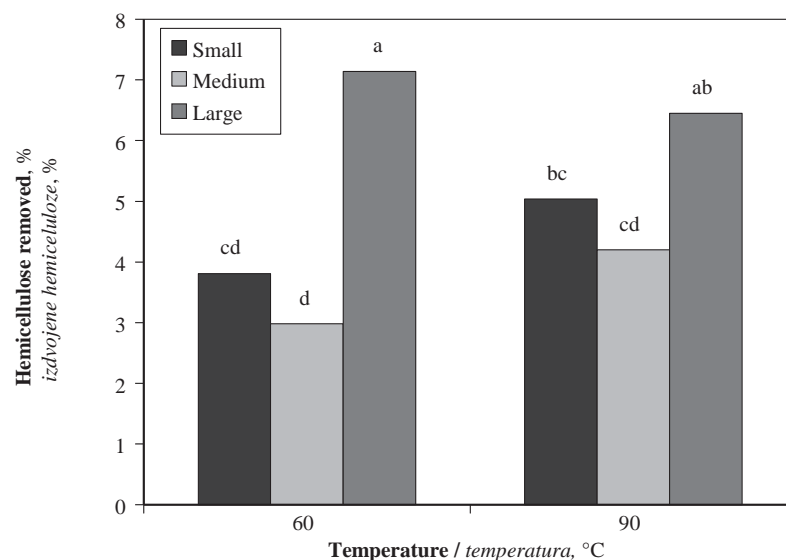

**Figure 1** The influence of hornbeam chips alkaline pre-hydrolysis variables on hemicelluloses removal (Lower case letters on the bars show the Duncan grouping of the averages)

**Slika 1.** Utjecaj varijabli alkalne predhidrolize sječke grabovine na izdvojene hemiceluloze (mala slova iznad stupaca prikazuju Duncanovo grupiranje prosjeka)

**Table 3** Analysis of variance of the effect of experimental variables on chemical components of pre-hydrolyzed hornbeam chips, hemicelluloses removal (*F* value and significance level)

**Tablica 3.** Analiza varijance utjecaja istraživanih varijabli na kemijski sastav predhidrolizirane sječke grabovine i izdvojene hemiceluloze (*F*-vrijednost i razina značajnosti)

Variables Varijable	Temperature Temperatura	Chip size Veličina sječke	Chip size × Temperature Veličina sječke × temperatura
Residual alkali / alkalni ostatak	3.612 <sup>ns</sup>	4.769*	0.2525 <sup>ns</sup>
Cellulose / celuloza	1.956 <sup>ns</sup>	61.839**	16.653**
Lignin / lignin	10.560**	3.956*	17.869**
Hemicelluloses removal / izdvojene hemiceluloze	1.163 <sup>ns</sup>	19.879**	4.067*

Significance level: \*\*,99 %; \*,95 %; ns, not significant / Razina značajnosti: \*\*,99 %; \*,95 %; ns, nije značajno

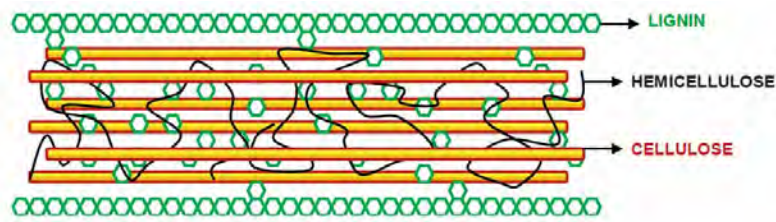

**Figure 2** Schematic presentation of cell wall structure showing the bonding between lignin and carbohydrates (Mussatto and Teixeira, 2010)

**Slika 2.** Shematski prikaz strukture stanične stijenke koji prikazuje vezu između lignina i ugljikohidrata (Mussatto i Teixeira, 2010.)

ture was better than at higher temperature. Even though less sodium hydroxide is absorbed at higher temperature, more hemicelluloses is removed, which shows the effectiveness of chip size on penetration of alkali.

The cellulose content of the treated chips was higher than that of untreated chips, because of the hemicelluloses removal. Otherwise the charged sodium hydroxide is not strong enough to degrade and dissolve the cellulose (Travaini *et al.*, 2016). The lignin content of the treated chips is marginally (about 2.5 % of the original content of 18 %) increased as well, which is also due to hemicelluloses removal and partial lignin hydrolysis (Travaini *et al.*, 2016).

### 3.1 Pulp properties

#### 3.1. Svojstva pulpe

The usual pulping process for hardwoods is kraft pulping, which provides fast reactions between pulping chemicals and lignin. Soda pulping reactions compared to kraft pulping is slow and pulping time is longer. However, in this study, soda pulping was selected to demonstrate the impact of pre-hydrolysis on pulping performance. The results of pulp properties measurements showed that chip prehydrolysis of chips facilitated the penetration of pulping chemicals and caused faster pulping reactions and lignin removal (Kautto *et al.*, 2010).

The results of the statistical analysis of the effect of prehydrolysis temperature and chip size on soda pulp properties are summarized in Table 4. The effect of

both variables on pulping total yield and the reject are statistically significant at 99 % coincidence level. However, the influence of the temperature on pulp drainage and kappa number is not significant, but the impact of chip size and the interactive effect of two variables were determined to be significant at either 99 % or 95 % confidence level (Table 4).

The total yield of the pulps produced from treated chips varied between the lowest value of 30.41 % using smallest chips and the highest value of 48.14 %. The total yield of pulp produced from untreated chips was 41.93 % (Figure 4). At smaller chip sizes, the total yield is lower, which indicates the effectiveness of the alkaline hydrolysis of the wood components (Vena *et al.*, 2010; Jahan *et al.*, 2012). Even though the total yield of the pulps does not vary too extensively, the pulping rejects measurement showed interesting results as the consequence of chip treatment. The amount of rejects of the pulps produced from treated chips is very low (0.83 % to 7.31 %) compared to 24.16 % for pulps from untreated chips. There is no statistically significant difference between the averages of the treated chips pulp rejects. The results of pulping yield and rejects measurement show that the chips alkaline prehydrolysis opens the structure of wood, undergoes hydrolysis and dissolves the hemicellulose (Figure 1), which facilitates the penetration of alkali into the wood structure and the removal of lignin. This phenomenon reduces the pulping yield, and the amount of reject (Jahan *et al.*, 2012; Vena *et al.*, 2010).

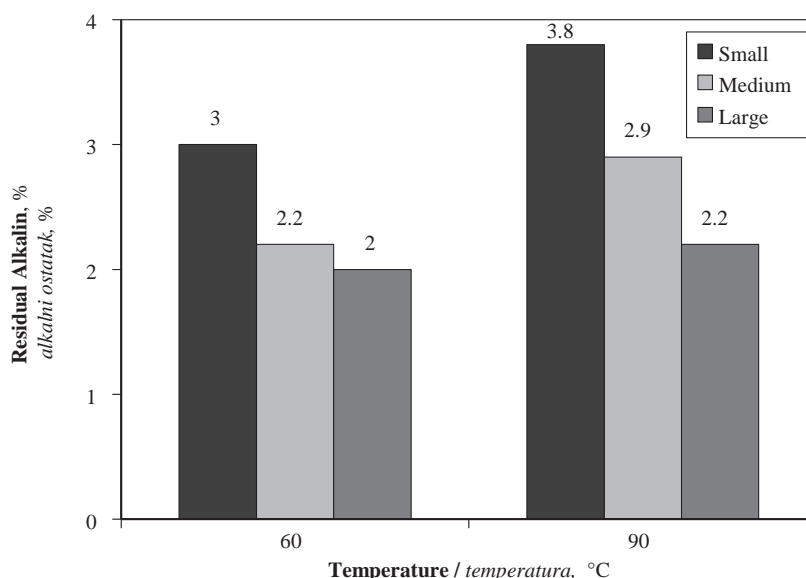

**Figure 3** The influence of hornbeam chips alkaline pre-hydrolysis variables on residual sodium hydroxide after treatment

**Slika 3.** Utjecaj varijabli alkalne predhidrolize sječke grabovine na preostali natrijev hidroksid nakon tretmana

**Table 4** Analysis of variance of the effect of experimental variables on properties of soda pulp produced from pre-hydrolyzed hornbeam chips (*F* value and significance level)**Tablica 4.** Analiza varijance utjecaja istraživanih varijabli na natronski postupak proizvodnje celuloze iz predhidrolizirane sječke grabovine (*F*-vrijednost i razina značajnosti)

Properties <i>Svojstva</i>	Variables <i>Varijable</i>	Temperature <i>Temperatura</i>	Chip size <i>Veličina sječke</i>	Chip size × Temperature <i>Veličina sječke × temperatura</i>
Total Yield / <i>ukupan prinos</i>		15.449**	77.519**	85.872**
Reject / <i>odbačeno</i>		0.502 <sup>ns</sup>	51.839**	2.640 <sup>ns</sup>
Drainage / <i>drenaža</i>		0.640 <sup>ns</sup>	11.360**	0.320 <sup>ns</sup>
Kappa No. / <i>Kappa broj</i>		0.732 <sup>ns</sup>	3.339*	4.852**
Tensile strength / <i>vlačna čvrstoća</i>		0.180 <sup>ns</sup>	65.498**	11.571**
Tear strength / <i>čvrstoća na kidanje</i>		0.001**	0.144 <sup>ns</sup>	0.217 <sup>ns</sup>

Significance level: \*\* ,99 % ; \* ,95 % ; ns, not significant / *Razina značajnosti: \*\* ,99 % ; \* ,95 % ; ns, nije značajno*

The kappa number of soda pulps prepared from treated chips was lower than that from un-treated chips (control), which indicates faster removal of lignin from treated chips (Jahan *et al.*, 2012; Vena *et al.*, 2010). The kappa number of pulps from treated chips ranges between the highest value of 34.73 and the lowest value of 28.42 compared to kappa number of control pulp (34.33) (Garcia *et al.*, 2011; Vena *et al.*, 2010). Of course, the kappa number of the pulp without reject (accept pulp) was measured. However, the results reveal that pre-hydrolysis breaks the lignin-carbohydrate bond and facilitates the lignin dissolution and removal (Travaini *et al.*, 2016; Li *et al.*, 2010). The measured drainage of the soda pulps was 17 °SR compared to 20 °SR for pulp from untreated chips. This also shows the potential of hydrophilic hemicelluloses to hold water and their removal causes easy water drainage from the pulp.

The strength properties of soda pulps produced from alkaline pre-hydrolyzed hornbeam chips are measured and the statistical analysis of the data is provided in Table 4. The alkaline pre-treatment of hornbeam chips reduced the tensile index of the soda pulps produced from the treated chips (Figure 5), but the tear

index of the pulp was only marginally improved (Figure 6) (Kautto *et al.*, 2010; Vena *et al.*, 2010; Jahan *et al.*, 2012). The effect of chip size and the combined effect of two variables on tensile index was statistically significant at 99 % confidence level. However, the effect of the variable on tear index was not statistically significant.

The presence of low molecular weight hemicelluloses in pulp fibers enhances the bonding potential of fibers. Hemicelluloses absorb more water compared to cellulose and develop more hydrogen bonds between the carbohydrates. The tensile index of paper produced from pulp fibers strongly depends on the intensity of hydrogen bonds. Elimination of hemicelluloses will reduce the number of hydrogen bonds and consequently lower tensile strength of the paper. The removal of hemicelluloses deteriorates the fiber to fiber bonding and the consequence of this phenomenon is also the reduction of paper tensile index (Kautto *et al.*, 2010). However, the removal of hemicelluloses from the wood cell wall initiates the fiber contraction followed by the so-called hornification phenomenon after paper drying, which improves the fiber inherent strength and tear index (Jahan *et al.*, 2010).

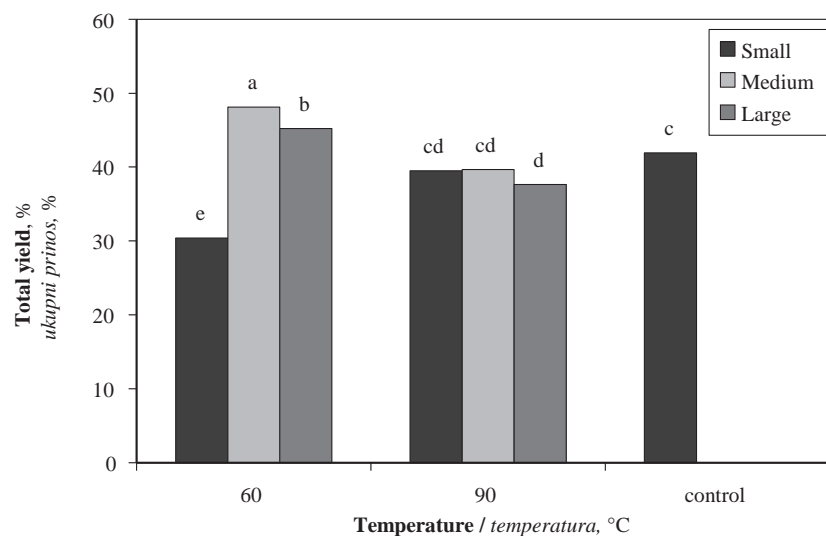
**Figure 4** The influence of hornbeam chips alkaline pre-hydrolysis variables on total yield of soda pulps (Lower case letters on the bars show the Duncan grouping of the averages)**Slika 4.** Utjecaj varijabli alkalne predhidrolize sječke grabovine na ukupan prinos natronski proizvedene celuloze (mala slova iznad stupaca prikazuju Duncanovo grupiranje prosjeka)

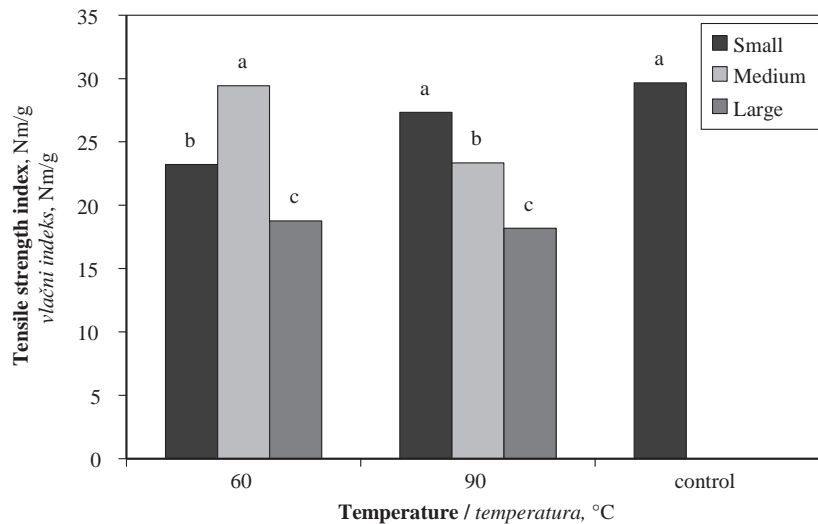

**Figure 5** The influence of hornbeam chips alkaline pre-hydrolysis variables on tensile index of soda pulps (Lower case letters on the bars show the Duncan grouping of the averages)

**Slika 5.** Utjecaj varijabli alkalne predhidrolize sječke grabovinena vlačni indeks natronski proizvedene celuloze (mala slova iznad stupaca prikazuju Duncanovo grupiranje prosjeka)

#### 4 CONCLUSIONS

##### 4. ZAKLJUČAK

Alkaline pre-hydrolysis of hornbeam wood chips can be used to remove up to 7.14 % of the hemicelluloses from hornbeam wood and breaks the lignin carbohydrate bonds. The disruption of the bond opens the structure of the cell wall and facilitates the penetration of pulping liquor. The soda cooking performance of the treated chips is faster than that of untreated chips and the pulping rejects of untreated chips are higher than those of treated chips.

Alkaline pre-hydrolysis and subsequent partial removal of hemicelluloses and disruption of the lignin-carbohydrate linkages facilitates the lignin removal. Therefore, the kappa number of the produced pulp was reduced. The treatment deteriorates the fiber to fiber bonding and reduces the tensile strength index of the soda pulps. However, the tear strength index is preserved and marginally improved, which can be attrib-

uted to better delignification as well as sound and longer fibers in the produced pulp.

Further research should be focused on temperature fields of the samples of other wood-based materials (such as chipboard, plywood), samples with wood joints, samples with treated surface, samples with flame retardant treatment, the use of radiant heat, etc.

##### Acknowledgements – Zahvala

The authors would like to express their sincere appreciation to Islamic Azad University, Karaj Branch for providing the financial support of this project.

#### 5 REFERENCES

##### 5. LITERATURA

1. Ayrilimis, N.; Kwon, J. H.; Han, T. H., 2017: Effect of wood chip size on hemicellulose extraction and technological properties of flakeboard. *Turkish Journal of Agriculture and Forestry*, 41: 331-337. <https://doi.org/10.3906/tar-1704-63>.

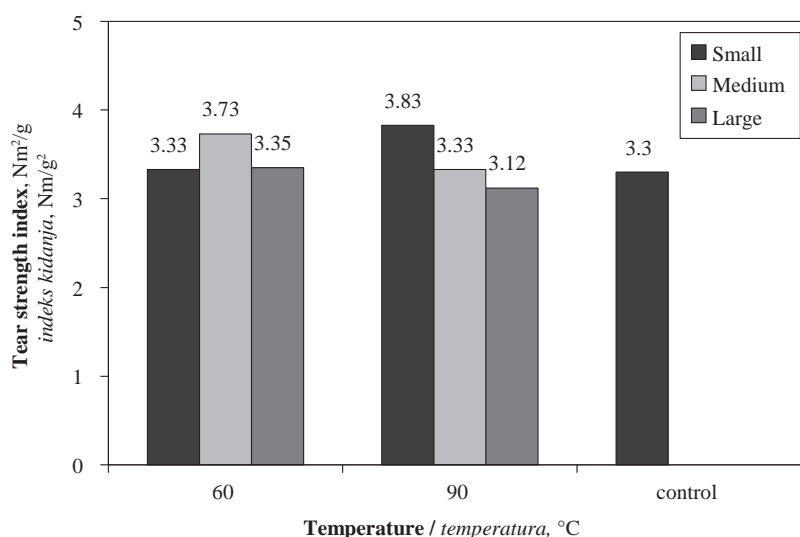

**Figure 6** The influence of hornbeam chips alkaline pre-hydrolysis variables on tear strength index of soda pulping

**Slika 6.** Utjecaj varijabli alkalne predhidrolize sječke grabovine na indeks kidanja natronski proizvedene celuloze

2. Boopathy, R.; Dawson, L., 2008: Cellulosic ethanol production from sugarcane bagasse without enzymatic saccharification. *Bioresources Technology*, 3 (2): 452-460.
3. Carvalheiro, F.; Duarte, L. C.; Girio, F. M., 2008: Hemicellulose biorefinery: A review on biomass pretreatment. *Journal of Scientific and Industrial Research*, 67: 849-864.
4. Cheng, H.; Zhan, H.; Fu, S., Lucia, L. A., 2010: Alkaline extraction of hemicellulose from depithed corn stover and effects on soda-AQ pulping. *BioResources*, 11 (1): 196-206.
5. Dawan, L.; Boopathy, R., 2008: Cellulosic ethanol production from sugarcane bagasse without enzymatic saccharification. *BioResources*, 3: 452-460.
6. Garcia, J. C.; Zamudio, M. A. M.; Perez, A.; Feria, M. J.; Gomide, J. L.; Colodette, J. L.; Lopez, F., 2011: Soda/AQ pulping of Paulownia wood after hydrolysis treatment. *BioResources*, 6 (2): 971-986.
7. Gulbrandsen, T. A.; Johnsen, I. A., Tanase Opedal, M.; Toven, K.; Yaas, K.; Pranovich, A.; Mikkola, J. P.; Hohh, B. H., 2015: Extracting hemicelluloses from softwood and bagasse as oligosaccharides using pure water and microwave heating. *Cellulose Chemistry and Technology*, 49 (2): 117-126.
8. Hatti-Kaul, R., 2010: Biorefinery- A path to sustainability. *Crop Science*, 50: S152.
9. Helmerius, J.; Vinblad van Walter, J.; Rova, U., Berglund, K. A.; Hodge, D. B., 2010: Impact of hemicelluloses pre-extraction for bio-conversion on birch kraft pulp properties. *Bioresources Technology*, 1011: 5996-6005. <https://doi.org/10.1016/j.biortech.2010.03.029>.
10. Jahan, M. S.; Rahman, M. M., 2012: Effect of pre-treatment on the soda-anthraquinone pulping of corn stalks and *Saccharium spontaneus* (kash). *Carbohydrate Polymer*, 88: 583-588. <https://doi.org/10.1016/j.carbpol.2012.01.005>.
11. Jiang, X.; Zhao, T.; Shi, Y.; Wang, J.; Li, J.; Yang, H., 2017: H<sub>2</sub>SO<sub>4</sub> and NaOH pretreatment to enhance bio-oil yield of pine wood liquedification in methanol. *BioResources*, 12 (2): 3801-3818. <https://doi.org/10.15376/biores.12.2.3801-3818>.
12. Kautto, J.; Saukkonen, E.; Henricson, K., 2010: Digestibility and paper making properties of pre-hydrolyzed softwood chips. *BioResources*, 5 (4): 2502-2519.
13. Kurian, J. K.; Minu, A. K.; Banerji, A.; Kishore, V. V. N., 2010: Bioconversion of hemicellulose hydrolysate of sweet sorghum bagasse to ethanol by using *Pichia stipites* NCIM 3497 and *Debaryomyces hansenii* sp. *BioResources*, 5 (4): 2404- 2416.
14. Li, H.; Saeed, A.; Jahan, M. S.; Ni, Y.; Van Heiningen, A., 2010: Hemicelluloses removal from hardwood chips in the re-hydrolysis step of the kraft based dissolving pulp production process. *Journal of Wood Chemistry and Technology*, 30: 48-60. <https://doi.org/10.1080/02773810903419227>.
15. Liu, W.; Yuan, Z.; Mao, C.; Hou, Q.; Li, K., 2011: Removal of hemicelluloses by NaOH pre-extraction from aspen chips prior to mechanical pulping. *BioResources*, 6 (3): 3469- 3480.
16. Liu, L.; Ren, J.; Zhang, Y.; Liu, X.; Ouyang, J., 2018: Simultaneously separation of xylo-oligosaccharide and lignosulfonate from wheat straw magnesium bisulfite pretreatment spent liquor using ion exchange resin. *Bioresources Technology*, 249: 189-195. <https://doi.org/10.1016/j.biortech.2017.09.207>.
17. Lu, X.; Lin, J.; Luo, L.; Zhang, D.; Lei, S.; Xiao, W.; Xu, Y.; Gong, Y.; Liu, Z., 2017: Enhanced enzymatic saccharification of sugarcane bagasse pretreated by sodium methoxide with glycerol. *Bioresources Technology*, 249: 226-233. <https://doi.org/10.1016/j.biortech.2017.09.137>.
18. Mirahmadi, K.; Mohseni Kabir, M.; Jehanipour, A.; Karimi, K.; Taherzadeh, M. J., 2010: Alkaline oretreatment of spruce and birch wood to improve bioethanol and biogas production. *Bioresources Technology*, 5 (2): 928-938.
19. Mussatto, S. I.; Teixeira, J. A., 2010. Lignocellulose as raw material in fermentation processes. In: Mendez-Vilas, A. (ed.). *Current Research, Technology and Education Topics in Microbiology and Microbial Biotechnology*, pp. 897-907.
20. Ormsby, R., Kastner, J. R.; Miller, J., 2012: Hemicellulose hydrolysis using solid acid catalysts generated from biochar. *Catalysis Today*, 190: 89-97. <https://doi.org/10.1016/j.cattod.2012.02.050>.
21. Shen, Z.; Zhang, K.; Si, M.; Liu, M.; Zhou, S.; Liu, D.; Ren, L.; Yan, X.; Shi, Y., 2018: Synergy of lignocelluloses pretreatment by sodium carbonate and bacterium to enhance enzymatic hydrolysis of rice straw. *Bioresources Technology*, 249: 154-160. <https://doi.org/10.1016/j.biortech.2017.10.008>.
22. Song, T., Pranovich, A.; Holmbom, R., 2011: Effect of pH control with phthalate buffer on hot water extraction of hemicelluloses from spruce wood. *Bioresources Technology*, 102: 10518-10523. <https://doi.org/10.1016/j.biortech.2011.08.093>.
23. Taherzadeh, M. J.; Karimi, K., 2007: Acid-based hydrolysis processes for ethanol from lignocellulosic material: A review. *BioResources*, 2 (3): 472- 499.
24. *Tappi standards and suggested methods*, 2008: Tappi press, Atlanta, GA, USA.
25. Travaini, R.; Martin-Juarez, J.; Lorenzo-Hernando, A.; Bolado-Rodriguez, S., 2016: Ozonolysis: An advantageous pretreatment for lignocellulosic biomass revisited. *Bioresources Technology*, 199: 2-12. <https://doi.org/10.1016/j.biortech.2015.08.143>.
26. Vachalova, R.; Maresova, I.; Kolar, L.; Vachal, J.; Triska, J., 2014: Lignocellulosic biorefinery for waste-free manufacturing of phytoestrogens belonging to lignans, sugars for production of ethanol and growing medium. *Wood Research*, 59 (4): 593-604.
27. Vena, P. F.; Gorgens, J. F.; Rypstra, T., 2010: Hemicelluloses extraction from giant bamboo prior to kraft and soda/AQ pulping to produce paper pulps, value-added biopolymer and bioethanol. *Cellulose Chemistry and Technology*, 44 (4-6): 153-163.
28. Yan, L.; Ma, R.; Bu, Q.; Li, L.; Zhau, X.; Xu, Y.; Hu, G., 2017: Characterization of value-added non- carbohydrate compounds solubilized during acidic hot water flow through pretreatment of poplar wood. *BioResources*, 12 (1): 899-911. <https://doi.org/10.15376/biores.12.1.899-911>.
29. Zhang, K.; Pei, Z.; Wang, D., 2015: Organic solvent pretreatment of lignocellulosic biomass for biofuels and biochemical: A review. *Bioresources Technology*, 199: 21-33. <https://doi.org/10.1016/j.biortech.2015.08.102>.

**Corresponding address:**

Prof. AHMAD JAHAN LATIBARI  
 Islamic Azad University, Karaj Branch  
 Department of Wood and Paper Science and Technology  
 Karaj, IRAN  
 e-mail: latibari.aj@gmail.com

# Assessment of Efficacy and Effectiveness of Some Extracted Bio-Chemicals as Bio-Fungicides on Wood

## Procjena učinkovitosti i djelotvornosti ekstrahiranih biokemikalija kao fungicida za drvo

### Original scientific paper • Izvorni znanstveni rad

Received – prispjelo: 27. 8. 2018.

Accepted – prihvaćeno: 20. 11. 2019.

UDK: 630\*841.513; 630\*874; 630\*874.11

<https://doi.org/10.5552/drvind.2019.1837>

**ABSTRACT** • The present study investigates *in-vitro* the antifungal activity of two extracts (ethyl ether extracts of *Schinus terebinthifolius* ripened fruits and *Pinus rigida* heartwood) and two essential oils (*Thymus vulgaris* and *Origanum majorana* leaves) against two species of fungi; *Trichoderma harzianum* and *Aspergillus niger*. The results clearly show that *O. majorana* oil and *P. rigida* wood extract had the highest activity against both fungi and were chosen for the application on four wood species; Weeping-Wreath Wattle (*Acacia saligna*), Beech (*Fagus sylvatica*), Black Walnut (*Juglans nigra*) and Pitch Pine (*Pinus rigida*). Additionally, their impact on the wood structure was examined by FTIR, SEM and colorimetry. The study suggests that *O. majorana* oil appears to show the best results and could be used as friendly bio-fungicides to protect wood objects without changing their structures.

**Keywords:** bio-fungicides, wood, essential oils, extracts, antifungal activity

**SAŽETAK** • U studiji je opisano istraživanje *in vitro* protugljivičnog djelovanja dvaju ekstrakata (etil eterskih ekstrakata iz zrelog ploda drva *Schinus terebinthifolius* i iz srži drva *Pinus rigida*) i dvaju esencijalnih ulja (iz lišća drva *Thymus vulgaris* i iz drva *Origanum majorana*) na dvije vrste gljiva, *Trichoderma harzianum* i *Aspergillus niger*. Rezultati jasno pokazuju da su ulje *O. majorana* i ekstrakt drva *P. rigida* imali najjače protugljivično djelovanje na obje vrste gljiva te su zato odabrani za primjenu na četiri vrste drva: drvu akacije (*Acacia saligna*), drvu bukve (*Fagus sylvatica*), drvu crnog oraha (*Juglans nigra*) i drvu bora (*Pinus rigida*). Ujedno je uz pomoć FTIR-a, SEM-a i kolorimetrije ispitan utjecaj tih ekstrakata i ulja na strukturu drva. Istraživanje pokazuje da su najbolji rezultati postignuti uljem iz lišća drva *O. majorane* i da se ono može upotrijebiti kao ekološki biofungicid za zaštitu drvenih predmeta, bez promjene strukture drva.

**Ključne riječi:** biofungicidi, drvo, esencijalna ulja, ekstrakti, protugljivično djelovanje

<sup>1</sup> Authors are associate professor at Alexandria University, Faculty of Agriculture (EL-Shatby), Forestry and Wood Technology Department, Alexandria, Egypt. <sup>2</sup> Author are professors at Cairo University, Faculty of Archaeology, Conservation Department, Giza, Egypt.

<sup>1</sup> Autor je izvanredni profesor Sveučilišta Aleksandrija, Agronomski fakultet (EL-Shatby), Zavod za šumarstvo i drvenu tehnologiju, Aleksandrija, Egipat. <sup>2</sup> Autori su profesori Sveučilišta Kairo, Arheološki fakultet, Zavod za konzervaciju, Giza, Egipat.

## 1 INTRODUCTION

### 1. UVOD

Natural products such as essential oil (EO) and extracts have been extensively used in many works as wood bio-fungicides treatment against the growth of mold fungi (Al-Huqail *et al.*, 2019; Behiry *et al.*, 2019; Salem *et al.*, 2019a, b). Molds can grow over the surface of wood, wooden products and other organic materials, and consume carbohydrates, and other simple sugars resulting in chemical and morphological changes of the material structure as well as leaving stains (Kerner-Gang and Schneider, 1969; Blanchette *et al.*, 1992; Zabel and Morrell, 1992; Fabbri *et al.*, 1997; Breuil, 1998; Hamed, 2013; Mansour and Salem, 2015; Xu *et al.*, 2015; Mesquita *et al.*, 2009; Salem, 2016; Salem *et al.*, 2016a,b; Hamed and Mansour, 2018). They can use proteins and triglycerides by colonizing ray parenchyma and cell lumen of sapwood (Breuil, 1998). Also, dark grey discoloration could be seen on wood surface as *Alternaria* and other molds grow (Domsch *et al.*, 2007).

Deteriorated wooden sculptures (Fazio *et al.*, 2011) and art photographs stored in the quarantine room of the Cultural Center of Belgrade have shown the presence of *Trichoderma viride*, *Chaetomium globosum*, *Aspergillus niger* and *Alternaria sp.* with proven cellulolytic activity (Ljaljević Grbić *et al.*, 2013). Pigments and colored spores are produced as the molds grow on wood surfaces resulting in wood discolorations (Viitanen and Ritschkoff, 1991; Ghosh *et al.*, 2008), and distortion of wood could take place without affecting its strength (Daniel, 2003). Decayed book-binding leather showed the presence of *C. globosum* as a very active organism (Strzelczyk *et al.*, 1987).

Nevertheless, natural durability of some woods has been achieved because of extractives presence i.e., tannins could prevent the growth of *Trametes versicolor* and *Serpula lacrymans* (Jeloková and Šindler, 1997). The presence of phenolic extractives and hydrophobic properties in tone pine (*Pinus pinea*) heartwood was linked to the higher durability against wood-decaying fungi (De Angelis *et al.*, 2018).

The existence of sugars in beech wood, for example, is responsible for the fungal attack (Jeloková and Šindler, 2001). Furthermore, the elemental composition of some wood species, *Pinus rigida*, *Juglans nigra*, and *Fagus sylvatica*, *Citharexylum spinosum* and *Morus alba*, changed after inoculation with *Penicillium sclerotigenum*, *Paecilomyces variotii*, and *Aspergillus niger* (Mansour *et al.*, 2015a; Salem, 2016). Other studies reported that the aging factors act synergistically to have a more prominent influence on less durable-wood compared to durable or preservative-treated wood (Žlahtič and Humar, 2017). Also, there is a strong correlation between the moisture content of the cell wall and the ability of microorganisms to degrade wood (Schmidt, 2006; Van Meel *et al.*, 2011; Meyer and Brischke, 2015).

Bio-products have a broad application as wood preservatives against the growth of mold and decay fungi. They are green alternatives for the synthetic fun-

gicides, since they are sustainably resourced and eco-friendly with extremely low toxicity to human beings and wooden artifacts (Philp *et al.*, 1995; Verma and Dubey, 1999; Qi and Jellison, 2004; Wang *et al.*, 2005; Kiran and Raveesha, 2006; Li *et al.*, 2013).

Recently, a wide range of research has been done on the antifungal activity of the natural extracts against the growth of fungi. EO of *Pinus rigida* wood at 5000 ppm showed complete inhibition against the growth of *A. alternata*, *Fusarium subglutinans*, *C. globosum*, and *A. niger*, while good inhibitions against *C. globosum* at 5000 ppm was found by applying the EO from *Eucalyptus camaldulensis* leaves (Salem *et al.*, 2016a). Wood specimens treated at the level of 2 % concentration of *P. rigida* heartwood extract showed good inhibition to mold growth under laboratory conditions (Salem *et al.*, 2016b). The combination of Paraloid B-72 and the methanolic extract of *C. sempervirens* wood might be used as a potential biocide against *T. harzianum* (Mansour and Salem, 2015).

This study aims to assess the efficacy of some bio-fungicides in fungi inhibition and their impact on the anatomical structure and chemical composition of wood after treatment and aging.

## 2 MATERIALS AND METHODS

### 2. MATERIJALI I METODE

#### 2.1 Plant extracts and essential oils

##### 2.1. Biljni ekstrakti i esencijalna ulja

Ripened fruits of *Schinus terebinthifolius* were collected from Alexandria, Egypt, while *Pinus rigida* heartwood was provided from wood sawmill (Alexandria, Egypt). *Thymus vulgaris* and *Origanum majorana* leaf essential oils were bought from the National Research Center, Cairo, Egypt. About 30 g from each of *S. terebinthifolius* fruits and *P. rigida* heartwood were soaked with 100 ml of ethyl ether for seven days (Salem *et al.*, 2013), and then filtrated using filter paper (Whatman no. 1). The solvent was evaporated under reduced pressure using rotary evaporator apparatus to concentrate the extract. Extracts and essential oils were stored in sealed tubes until use.

#### 2.2 Chemical analysis of essential oils/extracts by Gas Chromatography–Mass Spectrometry (GC-MS)

##### 2.2. Kemijska analiza esencijalnih ulja/ekstrakata plinskom kromatografijom s masenom spektrometrijom (GC-MS)

Chemical compositions of essential oils and extracts were analyzed using Focus GC-DSQ Mass Spectrometer (Thermo Scientific, Austin, TX) with a direct capillary column TG-5MS (30 m × 0.25 mm × 0.25 μm film thickness) apparatus located at the Atomic and Molecular Physics Unit, Experimental Nuclear Physics Department, Nuclear Research Center, Egyptian Atomic Energy Authority, Inshas, Cairo, Egypt. The program temperature and column conditions for the separation of compounds can be found in previous published works (Salem *et al.*, 2016c; Mohamed *et al.*, 2019; Salem *et al.*, 2019a, b).

The chemical constituents of extracts were identified based on MS library searches (NIST and Wiley), and by comparing with the MS literature data (NIST, 2011; Oberacher, 2011). GC/MS contains Xcalibur 3.0 data system-type threshold values for matching factors of Standard Index (SI) and Reverse Standard Index (RSI) for confirmation of all the mass spectra (MS) appended to the library. The match factor of getting MS and the library spectrum (LS) is called SI, while the match factor of getting MS and the LS, ignoring all peaks that are not in the LS, is called RSI. The values of these two standards were obtained from the mass spectrometer data base (Salem *et al.*, 2019b).

### 2.3 In-vitro antifungal assay

#### 2.3. In vitro protugljično ispitivanje

A culture of two fungi *Trichoderma harzianum* and *Aspergillus niger* was provided by the Laboratory of Microbiology, Conservation Department, Faculty of Archaeology, Cairo University, Egypt. Fungi were grown on Potato Dextrose Agar (PDA) medium at 26 °C. Extracts and EOs were prepared at the concentration of 1000, 500, 250 and 125 µg/ml by dissolving in dimethyl sulfoxide (DMSO, 100 %), and 0.5 ml of tween 80 was used with the oil to emulsify carrier oils in the solvent (Salem *et al.*, 2016a). After sterilizing the PDA medium, the concentrated tested materials were added and then poured into sterilized Petri dishes. Mycelial culture discs (0.5 cm diameter) of each fungus from 7-day-old culture were put in the center of Petri dishes. All the plates were incubated at 26 °C. The diameter of fungal growth was measured when it completely covered the Petri dishes in the control. The measurement was done in triplicates (Salem *et al.*, 2017). Inhibition percentage of mycelia growth was calculated as follows:

$$MGI\% = \frac{A_c - A_t}{A_c} \cdot 100 \quad (1)$$

Where the *MGI* is mycelial growth inhibition,  $A_c$  and  $A_t$  are average diameters of fungal colonies of control and treatment, respectively.

### 2.4 Preparation of wood samples

#### 2.4. Priprema uzoraka drva

Wood blocks (20 mm × 20 mm × 20 mm) of *Aca-cia saligna* sapwood (Alexandria, Egypt), as well as *Juglans nigra*, *Fagus sylvatica*, and *Pinus rigida* heartwood provided from wood sawmill (Alexandria, Egypt), prepared at the Laboratory of Wood Technology (Department of Forestry and Wood Technology, Faculty of Agriculture, Alexandria University, Egypt), were air-dried to a constant weight for the purpose of the present study. Each wood type samples was divided into three groups according to the application method of the selected bio-fungicides; the first one was treated by Spraying, the second one was treated by immersion and the third one was kept untreated and used for comparison. Three samples for each treatment method were evaluated in order to obtain the mean values.

### 2.5 Preparation of wood samples

#### 2.5. Priprema uzoraka drva

Wood samples were conditioned at 20±2 °C and a relative humidity of 55±5 % (RH) prior to and after

treatment. The EOs and extracts solutions were applied on wood samples by two methods: spraying and total immersion for 10 min into solution at room temperature. After the treatment, samples were left to dry on metal racks for a week. After that, the untreated and treated samples were subjected to accelerated aging in Binder 924030000200 oven for humid heat aging at 80 °C and a relative humidity of 65 % for 240 h at the National Institute of Standards (NIS) in Giza, Egypt. Finally, all samples were investigated.

### 2.6 Weight gain with oil and extracts

#### 2.6. Povećanje mase s uljem i ekstraktima

The penetration of the applied treatments was evaluated quantitatively based on sample weighing before and after the treatment. It was considered that the increase in mass of the treated samples was the result of the bio-fungicides uptake and retention into the wooden structure. Weight gain (*WG*, kg/m<sup>3</sup>) of wood samples with oils/extracts was measured (Salem *et al.*, 2017).

### 2.7 Examination with Fourier Transform Infrared (FTIR)

#### 2.7. Ispitivanje infracrvenom spektroskopijom s Fourierovom transformacijom (FTIR)

FTIR spectra for wood samples, which have been treated with the chosen bio-fungicides, were measured on a Nicolet 380 FT-IR Spectrometer, in the frequency range of 4000 - 400 cm<sup>-1</sup>, in transmission mode using the KBr pellet technique at the National Institute for Standards (NIS) in Cairo, Egypt. Peak heights and width of absorption bands were measured by essential FTIR software (version 310.041).

### 2.8 Examination with Fourier Transform Infrared (FTIR)

#### 2.8. Ispitivanje infracrvenom spektroskopijom s Fourierovom transformacijom (FTIR)

The determination of color changes due to the selected bio-fungicides was measured by using a Hunter lab colorimeter. Applying the CIE LAB color system, the color parameters  $L^*$ ,  $a^*$  and  $b^*$  as well as the overall change in color indices ( $\Delta E^*$ ) were determined in each sample before and after treatment and aging. The total color changes ( $\Delta E^*$ ) were calculated using the following equation (George, 1995);

$$\Delta E = \sqrt{(\Delta L^*)^2 + (\Delta a^*)^2 + (\Delta b^*)^2} \quad (2)$$

### 2.9 Environmental Scanning Electron Microscope (ESEM)

#### 2.9. Elektronski mikroskop za skeniranje u okolišu (ESEM)

The treated and untreated wooden samples were investigated using ESEM, Philips XL 30 at the central lab of the National Research Center in Giza, Egypt. This microscopic study was performed to monitor the penetration and changes resulting from treatment with the selected bio-fungicides within wood structure. Three samples were evaluated for each treatment.

### 2.10 Statistical analysis

#### 2.10. Statistička analiza

Extracts and Eos, as well as their concentrations, were subjected to analysis of variance with two factors



in CRD.  $LSD_{0.05}$  was used for the comparison among the means of treatment. All the values are presented in mean $\pm$ SD.

### 3 RESULTS AND DISCUSSION

#### 3. REZULTATI I RASPRAVA

##### 3.1 Chemical compositions of natural plant products

##### 3.1. Kemijski sastavi prirodnih biljnih proizvoda

Table 1 presents chemical compounds identified in the studied essential oils or extracts. Figure 1 shows the GC/MS chromatograms of ethyl ether extract from ripened fruits of *S. terebinthifolius* (Figure 1a), *T. vulgaris* leaf oil (Figure 1b, c) *O. majorana* leaf oil (Figure 1c), and ethyl ether extract from *P. rigida* wood (Figure 1d). The major components in the ethyl ether extract of *S. terebinthifolius* fruits were oleic acid (25.98 %),  $\delta$ -cadinene (7.52 %),  $\alpha$ -phellandrene (6.44 %), 1b,5,5,6 $\alpha$ -tetramethyloctahydro-6H-indeno[1,2-b]oxiren-6-one (6.10 %), aromadendrene (4.01 %), hexa-

decanoic acid-2,3-dihydroxypropyl ester (3.88 %),  $\alpha$ -caryophyllene (3.10 %), (Z,Z)-9,12-octadecadienoic acid (2.82 %),  $\alpha$ -bergamotene (2.77 %), dihydrohydrocarpic acid (2.36 %), and germacrene D (2.21 %). Other minor compounds, such as 9-octadecenamide (1.88 %), methyl-linolenate (1.74 %),  $\alpha$ -funebrene (1.71 %), methyl-6-oxoheptanoate (1.33 %), farnesol (1.23 %), *p*-cymene (1.22 %),  $\alpha$ -methyl-linolenate (1.15 %), glucopyranosyl-*D*-glucose (1.09 %), and *D*-stachyose (1.07 %) were identified.

Recently, acetone extract of ripened fruits showed good activity against some pathogenic bacteria, the main compounds being oleic acid,  $\alpha$ -phellandrene, and  $\delta$ -cadinene (Salem *et al.*, 2018). Bioflavonoids, free steroids, and terpenes, were also reported in *S. terebinthifolius* fruit extracts (Lloyd *et al.*, 1977; Kassem *et al.*, 2004; Lima *et al.*, 2006).

The main compounds of *T. vulgaris* leaf essential oil (EO) were carvacrol (9.08 %), terpinen-4-ol (7.05 %),  $\gamma$ -terpinene (5.52 %), estragole (4.57 %), *L*-camphor (4.50 %), linalool (4.73 %),  $\beta$ -caryophyllene (4.06 %),

**Table 1** Chemical composition of essential oils/extracts  
**Tablica 1.** Kemijski sastav esencijalnih ulja/ekstrakata

Essential oil/Extract Esencijalna ulja / ekstrakti	Compounds / Spojevi
Ethyl ether extract from ripened fruits of <i>S. terebinthifolius</i> etil eterski ekstrakt iz zrelih plodova drva <i>S. terebinthifolius</i>	$\alpha$ -Myrcene 0.85% (430,785)*, $\alpha$ -Phellandrene 6.44% (851,889), <i>p</i> -Cymene 1.22% (586,778), (+)- $\alpha$ -Terpineol 0.43% (441,797), Germacrene D 2.21% (683,816), $\alpha$ -Bergamotene 2.77% (711,870), $\beta$ -Caryophyllene 0.90% (582,787), $\alpha$ -Funebrene 1.71% (510,761), $\alpha$ -Carotene 0.82% (409,477), Aromadendrene 4.01% (720,795), $\alpha$ -Caryophyllene 3.10% (571,734), $\delta$ -Cadinene 7.52% (718,816), (-)-3- $\beta$ -acetoxy-5-etiinic acid 0.39% (525,743), Farnesol 1.23% (558,615), <i>D</i> -Stachyose 1.07% (596,678), Methyl 6-oxoheptanoate 1.33% (498,639), 4-O- $\alpha$ -D-glucopyranosyl- <i>D</i> -Glucose 1.09% (606,637), $\alpha$ -methyl-linolenate 1.15% (642,663), 4-O- $\alpha$ -D-galactopyranosyl- $\alpha$ -D-glucopyranose 0.88% (532,605), Methyl-linolenate 1.74% (692,699), 9-Octadecenamide 1.88% (612,650), 1b,5,5,6 $\alpha$ -Tetramethyloctahydro-6H-indeno[1,2-b]oxiren-6-one 6.10% (702,738), Cyclopropanetetradecanoic acid, 2-octyl-, methyl ester 0.86% (537,639), 5-Cyclopropylcarbonyloxypentadecane 0.89% (580,722), Hexadecanoic acid, 2,3-dihydroxypropyl ester 3.88% (622,650), Pentadecanoic acid 0.65% (630,687), (Z,Z)-9,12-Octadecadienoic acid 2.82% (688,718), Hexadecanoic acid, 2,3-dihydroxypropyl ester 0.91% (618,653), Oleic acid 25.98% (768,785), [1,1'-Bicyclopropyl]-2-octanoic acid, 2'-hexyl-, methyl ester 1.06% (639,734), 1,3-Diacetyl-2-oleoylglycerol 0.56% (557,737) Dihydrohydrocarpic 2.36% (629,807), and 10-Methyl-E-11-tridecen-1-ol propionate 0.36 (686,717).
<i>T. vulgaris</i> leaf essential oil esencijalno ulje iz lišća drva <i>T. vulgaris</i>	2-Methylbutyraldehyde 0.13% (791,901), 2-Ethyl-furan 0.08% (785,873), 2-Methylbutanoic acid 0.52% (892,926), 3-Thujene 3.17% (941,950), $\alpha$ -Pinene 3.32% (945,946), Camphene 2.29% (946,962), Sabinene 0.91% (950,966), $\beta$ -Pinene 1.09% (946,949), Myrcene 2.42% (937,941), 1-Octen-3-ol 2.35% (886,895), $\alpha$ -Phellandrene 0.60% (898,916), 3-Octanol 0.15% (772,837), $\alpha$ -Terpinene 3.95% (945,948), D-Limonene 1.60% (923,928), $\beta$ -Phellandrene 0.23% (921,936), <i>p</i> -Cymene 3.98% (945,953), Eucalyptol 1.99% (896,921), $\gamma$ -Terpinene 5.52% (940,946), Terpendiol II 0.09% (764,839), 2-Carene 1.34% (858,869), (Z)-Linalool oxide (furanoid) 0.08% (869,904), Linalool 4.73% (953,959), <i>p</i> - $\alpha$ -Dimethyl styrene 0.29% (822,884), Cis-4-Thujanol 1.22% (939,945), $\alpha$ -Thujone 1.45% (913,926), Isopulegol 0.87% (832,857), cis- <i>p</i> -Mentha-2,8-dien-1-ol 0.08% (768,825), cis-Para-2-menthen-1-ol 0.32% (903,919), Lavandulol 0.17% (849,875), Menthone 2.27% (904,916), L-Camphor 4.50% (888,936), Terpinen-4-ol 7.05% (916,921), trans-Piperitol 0.17% (806,896), $\beta$ -Fenchol 2.48% (944,947), Estragole 4.57% (937,948), 5-Isopropyl-2-methylanisole 3.32% (938,944), Nerol 0.50% (856,877), Laevo-Menthyl acetate 0.79% (833,919), D,L-Isobornyl acetate 0.79% (916,923), Carvone 2.82% (897,920), Piperitone 0.12% (791,842), Thymol 0.7% (859,894), Carvacrol 9.08% (801,803), $\beta$ -Elemene 0.13% (773,779), 3,9-Epoxy- <i>p</i> -mentha-1,8(10)-diene 0.60% (720,776), $\alpha$ -Bergamotene 0.69% (914,950), $\beta$ -Caryophyllene 4.06% (946,949), Caryophyllene 0.14% (806,844), $\alpha$ -Caryophyllene 0.56% (896,932), Methyl eugenol 1.41% (843,881), Methyl cinnamate 1.12% (847,904), $\beta$ -Cedrene 0.72% (853,863), $\alpha$ -Himachalene 0.34% (860,884), $\alpha$ -Muurolene 0.16% (848,894), Lepidozene 0.14% (799,856), $\gamma$ -Cadinene 1.54% (885,914), Farnesol 0.32% (808,824), Calamenene 0.39% (776,857), Palustrol 0.28% (793,823), Spathulenol 0.12% (788,866), $\beta$ -Caryophyllene oxide 0.88% (911,925), Epiglobulol 0.18% (753,795), 1-Heptatriacotanol 0.37% (808,825), .tau.-Cadinol 0.55% (847,894), Dotriacotanone 0.9% (825,849), 17-Pentatriacotanone 0.14% (777,788), and 14- $\beta$ -H-Pregna 0.14% (783,818).

**Table 1** Continue  
**Tablica 1.** Nastavak

<p><i>O. majorana</i> leaf essential oil <i>esencijalno ulje iz lišća drva O. majorana</i></p>	<p>2-Methylbutanoic acid methyl ester 0.15% (894,972), 3-Thujene 2.56% (926,934), <math>\alpha</math>-Pinene 3.15% (939,940), Camphene 0.28% (928,956), <i>trans</i>-sabinene hydrate 5.79% (960,960), <math>\beta</math>-Pinene 1.23% (953,954), Myrcene 3.35% (951,952), Yomogi alcohol A 0.08% (713,733), <math>\alpha</math>-phellandrene 0.90% (925,929), <math>\alpha</math>-Terpinene 5.83% (949,953), Limonene 4.77% (931,933), Sabinene 4.02% (942,949), <i>p</i>-Cymene 5.38% (944,952), <math>\gamma</math>-Terpinene 6.71% (942,948), Artemisia ketone 1.14% (936,963), Terpinolene 3.22% (886,936), <i>cis</i>-4-Thujanol 3.25% (940,943), Linalool 2.24% (949,959), <i>cis</i>-<math>\beta</math>-Terpineol 0.11% (938,944), dextro-2,8-para-menthadien-1-ol 0.07% (795,824), <math>\alpha</math>-Campholenal 0.04% (833,909), Isopinocarveol 0.05% (859,897), Isogeraniol 0.24% (774,776), Camphor 0.20% (894,950), 4-Carvomenthenol 5.73% (929,934), Isoborneol 0.84% (828,833), <i>trans</i>-piperitol 1.12% (900,921), <math>\beta</math>-Fenchol 5.16% (947,958), (<i>Z</i>)-Piperitol 1.16% (870,886), Linalyl acetate 3.14% (890,944), 2-Isopropyl-5-methyl-anisole 0.07% (834,870), <i>Cis</i>-sabinene hydrate acetate 0.13% (821,921), Cyclopropane-1-cyclopropylethynyl-2-methoxy-3,3-dimethyl- 0.16% (727,790), <i>E</i>-Farnesene epoxide 0.12% (764,787), Geraniol 0.22% (856,883), <i>d</i>-Verbenol 0.11% (785,824), <math>\alpha</math>-Fenchyl acetate 0.17% (856,881), Carvone 0.43% (775,818), Dimethyl hexynediol 0.04% (746,804), Thymol 2.91% (912,936), 5-Isopropyl-2-methylphenol 0.26% (840,851), 5-Isopropyl-2-methylphenol 0.26% (840,851), (<i>Z,E</i>)-Farnesol 0.11% (759,797), Ledol 0.15% (772,786), Geranyl vinyl ether 0.27% (764,781), <math>\alpha</math>-Bergamotene 0.11% (795,875), <math>\beta</math>-Caryophyllene 4.36% (942,949), 2-methoxy-5-propenyl- (<i>E</i>)-Phenol 0.09% (773,797), Longifolene 0.04% (777,787), <math>\alpha</math>-Caryophyllene 0.42% (886,931), Caryophyllene oxide 0.08% (700,737), 2,5-Octadecadienoic acid, methyl ester 0.05% (721,743), (+)-<math>\beta</math>-Cedrene 0.10% (800,826), Nerolidyl acetate 0.17% (815,817), <math>\gamma</math>-Elemene 3.02% (898,900), <math>\gamma</math>-Murolene 0.22% (816,866), 2-Dodecen-1-yl(-)succinic anhydride 0.05% (760,821), Spathulenol 0.28% (860,914), Caryophyllene oxide 0.35% (895,919), <math>\gamma</math>-Eudesmol 0.17% (808,885), <math>\beta</math>-cedrene 0.42% (778,815), 1-Heptatriacotanol 0.16% (777,784), Globulol 0.55% (846,885), 2-methylene-5<math>\alpha</math>-Cholestan-3<math>\beta</math>-ol 0.1% (785,841), and Dotriacontane 0.15% (815,830).</p>
<p>Ethyl ether extract from <i>P. rigida</i> wood <i>etil eterski ekstrakt iz drva P. rigida</i></p>	<p><math>\beta</math>-Thujene 0.56% (878,950), <math>\alpha</math>-Pinene 0.71% (899,935), 2,4(10)-Thujadiene 0.41% (801,897), Sabinene 5.75% (959,960), Myrcene 0.90% (914,943), <math>\alpha</math>-Phellandrene 0.32% (831,861), <math>\alpha</math>-Terpinene 4.94% (919,924), <i>Laevo</i>-Limonene 1.50% (907,941), Sabinene 1.01% (915,942), <i>o</i>-Cymene 2.03% (915,947), <math>\gamma</math>-Terpinene 7.69% (952,954), 4-Thujanol 3.27% (872,879), Linalool 0.40% (785,873), <i>cis</i>-4-Thujanol 10.24% (945,952), Fenchol 5.59% (934,937), <i>cis</i>-<i>p</i>-2-menthen-1-ol 0.53% (779,856), Isopinocarveol 0.67% (818,884), <i>D,L</i>-Isoborneol 1.08% (787,816), Terpinen-4-ol 18.66% (925,927), <math>\alpha</math>-Terpineol 9.49% (940,945), Linalyl acetate 1.17% (747,810), 2,5-Norbornanedione 0.70% (736,821), 3-Oxo-2-oxabicyclo[2.2.1]heptane-5-carboxylic acid 2.55% (748,798), Thymol 1.07% (769,851), Terpin anhydrous 2.20% (865,910), Caryophyllene 1.33% (827,872), 2-Methyl-1-hexadecanol 2.83% (767,780), 14-<math>\beta</math>-H-Pregna 5.02% (778,809), Nerolidyl propionate 0.55% (756,792), 5<math>\alpha</math>-Cholestan-3<math>\beta</math>-ol 0.64% (767,805), Dotriacontane 0.52% (787,801), 1-Heptatriacotanol 1.83% (738,751) and 17-Pentatriacontene 3.85% (805,810).</p>

\* Values in parentheses are (SI: Standard Index, RSI: Reverse Standard Index). / *Vrijednosti u zagradama su SI – standardni indeks, RSI – obrnuti standardni indeks.*

*p*-cymene (3.98 %),  $\alpha$ -terpinene (3.95 %), 5-isopropyl-2-methylanisole (3.32 %),  $\alpha$ -pinene (3.32 %), and 3-thujene (3.17 %). *T. vulgaris* grown in Spain with EO showed high antibacterial activity at high concentration and the oil had a high content of linalool, terpineol-4,  $\gamma$ -terpinene and myrcene (Ballester-Costa *et al.*, 2013), while in Morocco, the main components of the plant EO were camphor, camphene and  $\alpha$ -pinene (Imelouane *et al.*, 2009). In Egypt, thymol,  $\gamma$ -terpinene, and *p*-cymene were the main compounds in the EO from Egyptian plant (Viuda-Martoset *et al.*, 2010).  $\alpha$ -pinene, thymol and caryophyllene were the main compounds in the oil from *T. vulgaris* collected from Saudi Arabian market (Al-Asmari *et al.*, 2017). Thymol and *p*-cymene were reported as major in *T. vulgaris* plants collected from Serbia (Nikolić *et al.*, 2014).

The main compounds in leaf EO of *O. majorana* were 4-carvomenthenol (5.73 %),  $\gamma$ -terpinene (6.71 %),  $\alpha$ -terpinene (5.83 %), *trans*-sabinene hydrate (5.79 %), *p*-cymene (5.38 %),  $\beta$ -fenchol (5.16 %), limonene (4.77 %),  $\beta$ -caryophyllene (4.36 %), sabinene (4.02 %), myrcene (3.35 %), *cis*-4-thujanol (3.25 %), terpin-

olene (3.22 %),  $\alpha$ -pinene (3.15 %), linalyl acetate (3.14 %), and  $\gamma$ -elemene (3.02 %).

Libyan *O. majorana* EO, with *trans*-sabinene hydrate, terpinen-4-ol, *cis*-sabinene hydrate and carvacrol as main compounds, was observed as a good antibacterial agent (Ibrahim *et al.*, 2017). Romania EO of *O. majorana* showed the main compounds linalyl acetate,  $\gamma$ -terpinene and benzene (Rus *et al.*, 2015). *Trans*-sabinene hydrate, terpinene-4-ol and  $\gamma$ -terpinene were observed in Turkish plant (Arslan and Dervis, 2010). Terpinen-4-ol,  $\gamma$ -terpinene, *cis*-sabinene hydrate,  $\alpha$ -terpinene, sabinene and  $\alpha$ -terpineol were the main compounds (Busattaa *et al.*, 2008). Terpinen-4-ol, *cis*-sabinene hydrate, *p*-cymene and  $\gamma$ -terpinene were found in the plant grown in Reunion Island (Vera and Chane-Ming, 1999), while the main constituents of the plant from Venezuelan Andes were *cis*-sabinene hydrate, terpinen-4-ol and  $\gamma$ -terpinene (Ramos *et al.*, 2011).

The main constituents of wood ethyl ether extract of *P. rigida* were terpinen-4-ol (18.66 %), *cis*-4-thujanol (10.24 %),  $\alpha$ -terpineol (9.49 %),  $\gamma$ -terpinene (7.69

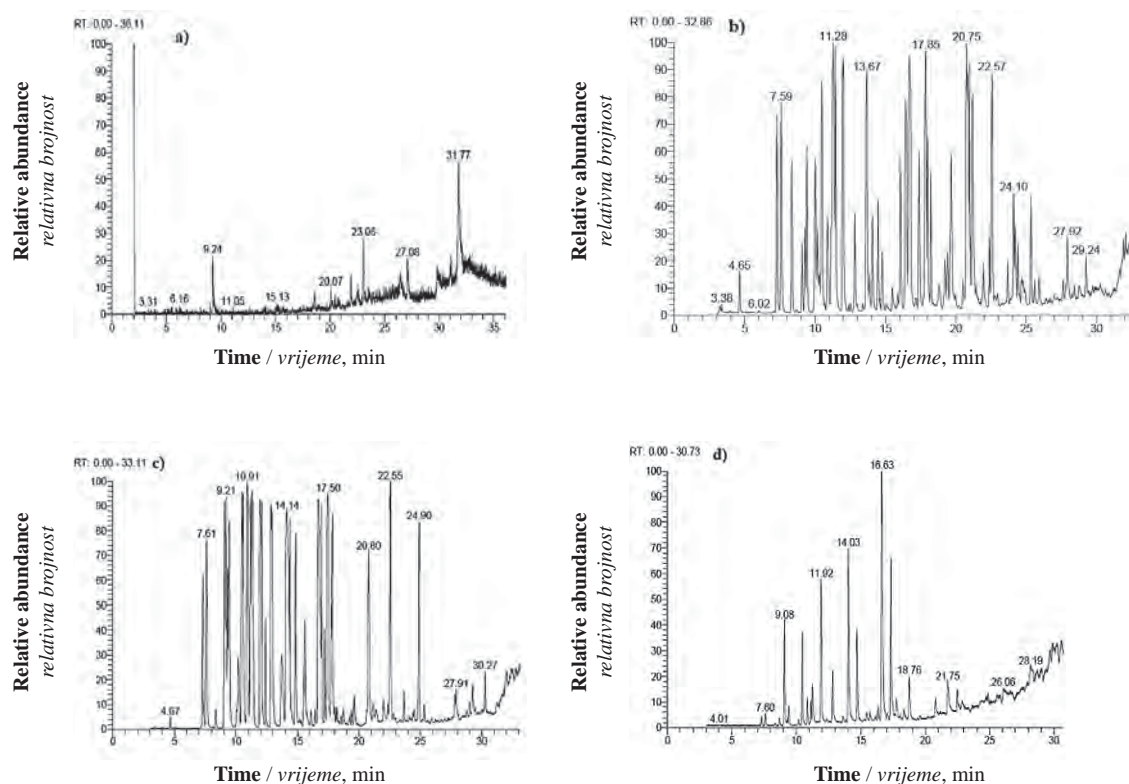

**Figure 1** GC/MS Chromatograms of the studied extracts and essential oils: a) Ethyl ether extract from ripened fruits of *S. terebinthifolius*; b) *T. vulgaris* leaf oil; c) *O. majorana* leaf oil; and d) ethyl ether extract from *P. rigida* wood  
**Slika 1.** GC/MS kromatogrami istraživanih ekstrakata i esencijalnih ulja: a) etil eterski ekstrakt iz zrelih plodova drva *S. terebinthifolius*; b) esencijalno ulje iz lišća drva *T. vulgaris*; c) esencijalno ulje iz lišća drva *O. majorana* i d) etil eterski ekstrakt iz drva *P. rigida*

%), sabinene (5.75 %), fenchol (5.59 %), 14- $\beta$ -H-pregna (5.02 %) and  $\alpha$ -terpinene (4.94 %). Methanol extract *P. rigida* was found to have  $\alpha$ -terpineol, borneol, terpin hydrate, D-fenchyl alcohol glycol and limonene as main compounds (Salem *et al.*, 2016b).

### 3.2 Antifungal activity of extracts and essential oils

#### 3.2. Protugljivično djelovanje ekstrakata i esencijalnih ulja

Generally, the complete inhibition (100 %) of the tested fungi was observed with the highest concentration (1000  $\mu$ g/ml) from all the tested EOs and extracts. According to the results reported in Table 2, *O. majorana* EO inhibited the growth of *T. harzianum* at all the concentrations tested. Also, the highest inhibition (87.77 %) of *A. niger* mycelial growth was observed with the lowest concentration of 125  $\mu$ g/ml from *O. majorana* EO, compared to 83.33 %, 85.55 % and 4.44 %, with *T. vulgaris* EO, *P. rigida* wood and *S. terebinthifolius* fruit extracts, respectively, at the same concentration.

Previously, *T. harzianum* showed resistance to tebuconazol (Obanda *et al.*, 2008). *T. harzianum* has been reported to colonize wooden substratum (Ljaljević-Grbić *et al.*, 2013), and poles manufactured from wood treated with CCA (Wang and Zabel, 1990; Kim *et al.*, 2007). Some good trials were achieved by using the natural products against the growth of *T. harzianum*,

where the heartwood methanolic extracts of *Morus alba* and bark *Maclura pomifera* showed significant effects. The treated wood samples of *Acacia saligna* wood treated with wood methanolic extract of *Cupressus sempervirens* showed the zone of inhibition at the concentrations of 5, 10, and 20 % (Mansour and Salem, 2015).

The EO of *T. vulgaris* showed fungitoxic spectrum against *A. flavus*, *Fusarium oxysporum*, *Curvularia lunata*, *A. terreus*, *A. niger*, *A. fumigatus*, *Cladosporium herbarum*, *Alternaria alternata* and *Botryodiplodia theobromae* (Kumar *et al.*, 2008). EO of the marjoram (Lakhrissi *et al.*, 2016) and *T. vulgaris* (Nikolić *et al.*, 2014) had good activity against *Candida albicans*. *O. majorana* EO showed fungicidal effect against *Verticillium dahliae* and *Penicillium aurantiogriseum* (Rus *et al.*, 2015). *S. terebinthifolius* extract with high content of phenolic compounds had good activity against the fungus *Paracoccidioides brasiliensis* (Johann *et al.*, 2010) and *Can. albicans* (Schmourlo *et al.*, 2005; Braga *et al.*, 2007). Promising antifungal activity was obtained against *A. alternata*, *F. subglutinans*, *C. globosum*, *A. niger* and *T. viride*, when methanol extract/EO of *P. rigida* wood was applied to wood (Salem *et al.*, 2016a, b).

It can be concluded from Table 5 that the *O. majorana* EO and *P. rigida* wood extract had the highest activity against the tested fungi, and consequently, they were chosen for the application methods.

**Table 2** Inhibition percentage of mycelia growth of *T. harzianum* and *A. niger*

**Tablica 2.** Postotak inhibicije rasta micelija gljiva *T. harzianum* i *A. niger*

Extract/EO <i>Ekstrakt / eterično ulje</i>	Concentration, µg/ml <i>Koncentracija, µg/ml</i>	Mycelia inhibition percentage <i>Postotak inhibicije micelija</i>	
		<i>T. harzianum</i>	<i>A. niger</i>
<i>T. vulgaris</i> EO	0	0.00e	0.00f
	125	41.11d±1.11	83.33c±1.11
	250	76.66c±1.11	100a
	500	84.44b±1.11	100a
	1000	100a	100a
<i>O. majorana</i> EO	0	0.00e	0.00f
	125	100a	87.77b±1.11
	250	100a	100a
	500	100a	100a
	1000	100a	100a
<i>P. rigida</i> wood extract	0	0.00e	0.00f
	125	100a	85.55bc±1.11
	250	100a	100a
	500	100a	100a
	1000	100a	100a
<i>S. terebinthifolius</i> fruit extract	0	0.00e	0.00
	125	46.66±1.11	4.44e±1.11
	250	82.22ab±1.11	14.44d±1.11
	500	100a	100a
	1000	100a	100a

Means with the same letters within the same column are not significantly different according to LSD<sub>0.05</sub> / *Srednje vrijednosti s istim slovom unutar istog stupca nisu značajno različite prema LSD<sub>0.05</sub>*

### 3.3 Weight gain (kg/m<sup>3</sup>)

#### 3.3. Povećanje mase (kg/m<sup>3</sup>)

Wood species were treated with *P. rigida* wood extract and leaf EO of *O. majorana* at the concatenation of 125 µg/ml for both methods (spray and immersion). Higher retentions were achieved in *F. sylvatica* wood with weight gain (kg/m<sup>3</sup>) of 8.16, 15.33, 12.08 and 12.12 %, using oil spray, oil immersion, extract spray and extract immersion methods, respectively (Table 3).

### 3.4 FTIR spectra of treated woods

#### 3.4. FTIR spektri obrađenih uzoraka drva

Figure 2a, b, c, and d presents the FTIR spectra of *A. saligna*, *J. nigra*, *F. sylvatica* and *P. rigida* woods, respectively, treated with either EO or extract by means of spray or immersion application methods. Treated and

untreated samples exhibited the characteristic bands of wood (Owen *et al.*, 1993; Ferraz *et al.*, 2000; Pandey and Pitman, 2003; Tolvaj, 2009), as shown in Table 4.

For *A. saligna* (Figure 2a), and *J. nigra* (Figure 2b) nearly no changes were observed in functional groups of wood treated with EO or extract. However, wood treated with extract by immersion showed a decrease in the intensity of functional groups. No changes were found in *F. sylvatica* samples treated with extract or EO compared with the control sample (Figure 2c). For *P. rigida* (Figure 2d), the intensity of the absorption at the region from 350 to 1550 cm<sup>-1</sup> was increased in samples treated with EO by immersion method and in samples treated with extract by spraying and immersion methods, which corresponds to C-H ranged from strong-stretch to medium-weak (alkenes, vinyl and aromatics) (Sun *et al.*, 2005).

**Table 3** Wood weight gain (WG) after the treatment with oil and extract by spray and immersion methods

**Tablica 3.** Povećanje mase (WG) nakon obrade uzoraka uljem i ekstraktom postupkom štrcanja i uranjanja

Wood sample <i>Uzorak drva</i>	WG, kg/m <sup>3</sup>			
	<i>O. majorana</i> EO / <i>Esencijalno ulje iz lišća drva O. majorana</i>		<i>P. rigida</i> ethyl ether extract <i>Etil eterski ekstrakt iz drva P. rigida</i>	
	Spray method <i>Štrcanje</i>	Immersion method <i>Uranjanje</i>	Spray method <i>Štrcanje</i>	Immersion method <i>Uranjanje</i>
<i>A. saligna</i>	4.66ab ± 2.58	5.71b ± 0.43	5.29b ± 1.82	6.33b ± 0.92
<i>J. nigra</i>	3.91b ± 0.31	7.33b ± 1.66	3.58b ± 1.21	7.41b ± 0.81
<i>F. sylvatica</i>	8.16a ± 1.33	15.33a ± 5.34	12.08a ± 0.92	12.12a ± 0.45
<i>P. rigida</i>	5.50ab ± 2.34	7.33b ± 1.44	4.41b ± 1.82	7.50b ± 1.47
LSD 0.05	3.52	5.45	2.81	1.85

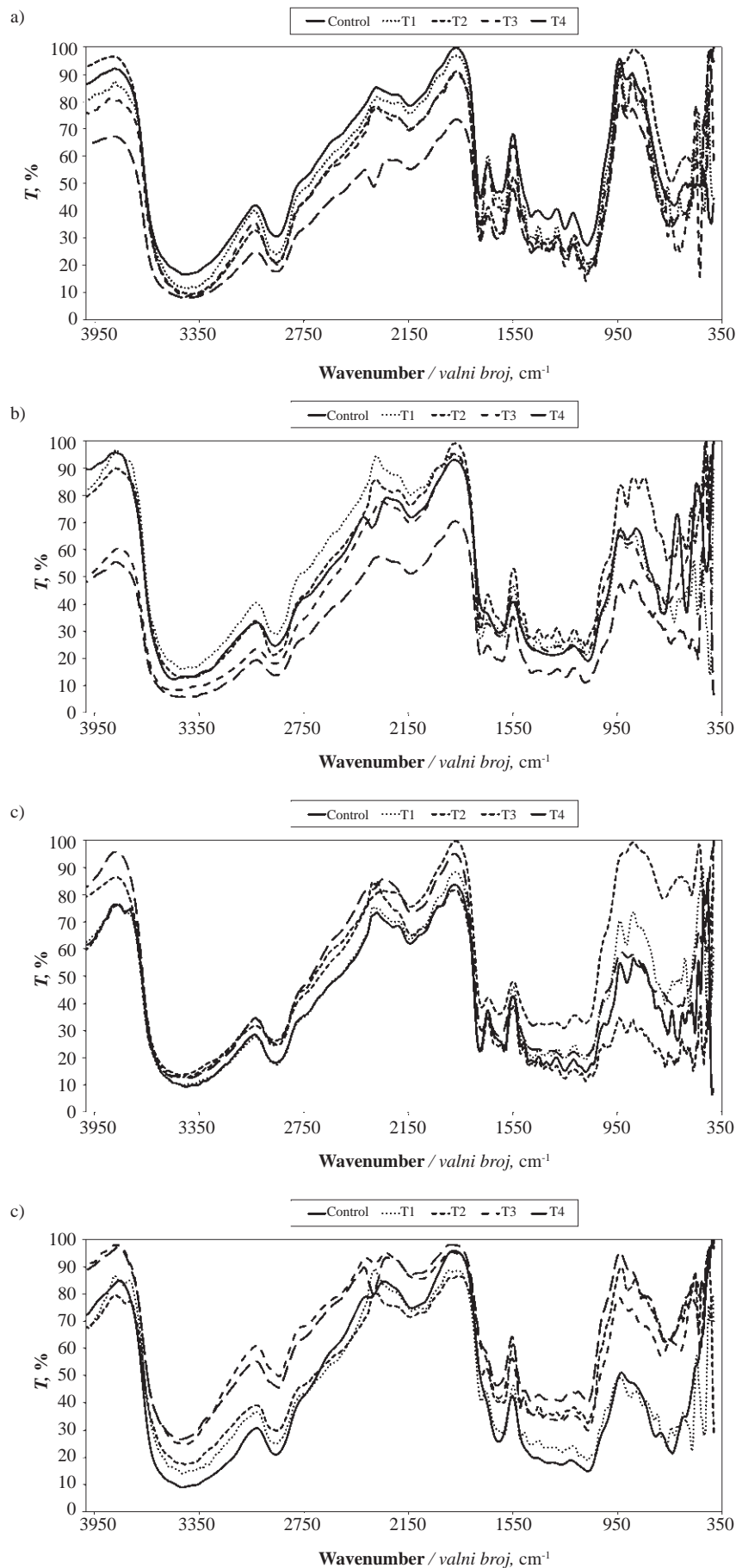

**Figure 2** FTIR spectra of wood samples treated with oils and extracts with two methods T1: Oil spray; T2: Oil immersion; T3: Extract spray; T4: Extract immersion. a) *A. saligna*; b) *J. nigra*; c) *F. sylvatica*; d) *P. rigida*  
**Slika 2.** FTIR spektri obrađenih uzoraka drva uljima i ekstraktima dvjema metodama: T1 – štrcanje ulja; T2 – uranjanje u ulje; T3 – štrcanje ekstrakta; T4 – uranjanje u ekstrakt; a) *A. saligna*; b) *J. nigra*; c) *F. sylvatica*; d) *P. rigida*

**Table 4** Functional groups in treated and untreated wood samples

**Tablica 4.** Funkcionalne skupine na obrađenim i neobrađenim uzorcima drva

Wave-number, cm <sup>-1</sup> Valni broj, cm <sup>-1</sup>	Functional group bands Veze funkcionalnih skupina	Assignment Pripisano spoju
3300-3400	OH stretching	Cellulose, Lignin and hemicellulose
2900	C-H <sub>2</sub> asymmetric stretching	Cellulose, Lignin and hemicellulose
1730	Unconjugated C=O stretching as a shoulder	Xylan and hemicellulose
1633	Absorbed O-H and conjugated C=O	Due to oxidation of cellulose
1605	C=C stretching of the aromatic ring	Lignin (Syringyl > Guaiacyl)
1509	C=C stretching of the aromatic ring	Lignin (Syringyl < Guaiacyl)
1434	CH <sub>2</sub> scissor vibration	Cellulose (crystallized and amorphous)
1370	C-H deformation	In cellulose and hemicellulose
1326	C-H vibration in cellulose and C-O vibration	In syringyl derivatives.
1248	Syringyl ring and C-O stretch	In lignin (Syringyl) and xylan.
1150-1265	C-O-C bridge oxygen stretching	Cellulose
1110	C-O stretching	Cellulose and hemicellulose
894	C-H deformation	cellulose
670	COH out-of-plane bending	cellulose

**Table 5** Chromatic parameters of samples measured in the L\*, a\*, b\* color system

**Tablica 5.** Kromatski parametri uzoraka izmjerenih u sustavu boja L\*, a\*, b\*

Wood sample Uzorak drva	$\Delta E^*$			
	<i>O. majorana</i> EO <i>Esencijalno ulje iz lišća drva O. majorana</i>		<i>P. rigida</i> ethyl ether extract <i>Etil eterski ekstrakt iz drva P. rigida</i>	
	Spray method <i>Štrcanje</i>	Immersion method <i>Uranjanje</i>	Spray method <i>Štrcanje</i>	Immersion method <i>Uranjanje</i>
<i>A. saligna</i>	1.06	1.29	0.64	1.38
<i>J. nigra</i>	0.50	0.52	2.13	2.28
<i>F. sylvatica</i>	0.76	0.48	1.89	2.52
<i>P. rigida</i>	0.91	0.78	1.59	2.50

### 3.5 Chromatic alternation of treated wood samples

#### 3.5. Kromatska svojstva obrađenih uzoraka drva

The color change measurements presented in Table 5 showed that the wood samples treated with *O. majorana* EO by both methods (spray and immersion methods) had the lowest  $\Delta E$ . These lowest values of  $\Delta E$  suggested that the treatments with 125  $\mu\text{g/ml}$  kept the wood at nearly its original color.

### 3.6 SEM examination

#### 3.6. SEM ispitivanje

Samples that did not show any changes in previous investigations after treatment and aging were examined by SEM to evaluate their distribution and penetration in the wood surface. So, wood samples treated with *O. majorana* EO showed good results. Application of oils and extracts by immersion apparently bring about an effect of increasing the distribution and penetration of EO in the wood surface. Also, the results revealed that the EO penetrated and distributed in a better way on the surface of *A. saligna* and *F. sylvatica* (Figures 3 and 4) than on the surface of *J. nigra* and *P. rigida* (Figures 5 and 6). No drastic changes were seen in the micrographs; on the contrary the EO treatment apparently achieved the consolidation of wood tissue. The microscopic investigation proved that the success and effectiveness of the treatment can be attributed to

the wood type and the application method. However, samples treated by immersion have considerably higher absorption value than the ones treated by spraying, as confirmed by weighing samples before and after treatments.

## 4 CONCLUSIONS

### 4. ZAKLJUČAK

In the present study, two extracts (ethyl ether extracts of *S. terebinthifolius* ripened fruits and *P. rigida* heartwood) and two essential oils (*T. vulgaris* and *O. majorana* leaves) were used to assess their antifungal activity against *T. harzianum* and *A. niger*. The results showed that *O. majorana* EO and *P. rigida* wood extract had the highest activity against both fungi and were chosen for the application on wood samples of *A. saligna*, *F. sylvatica*, *J. nigra* and *P. rigida*. The increases in color changes of wood samples due to *P. rigida* wood extract suggest that it is unsuitable for application on wood. Significant penetration of *O. majorana* EO in wood structure especially by immersion method not only increases its efficacy as a bio-fungicide but also consolidates the wood tissue. Overall, however, *O. majorana* oil appears to be the most promising. Future experiments may examine mixing these natural materials with natural polymers used as wood consolidants to enhance their anti-fungal properties.

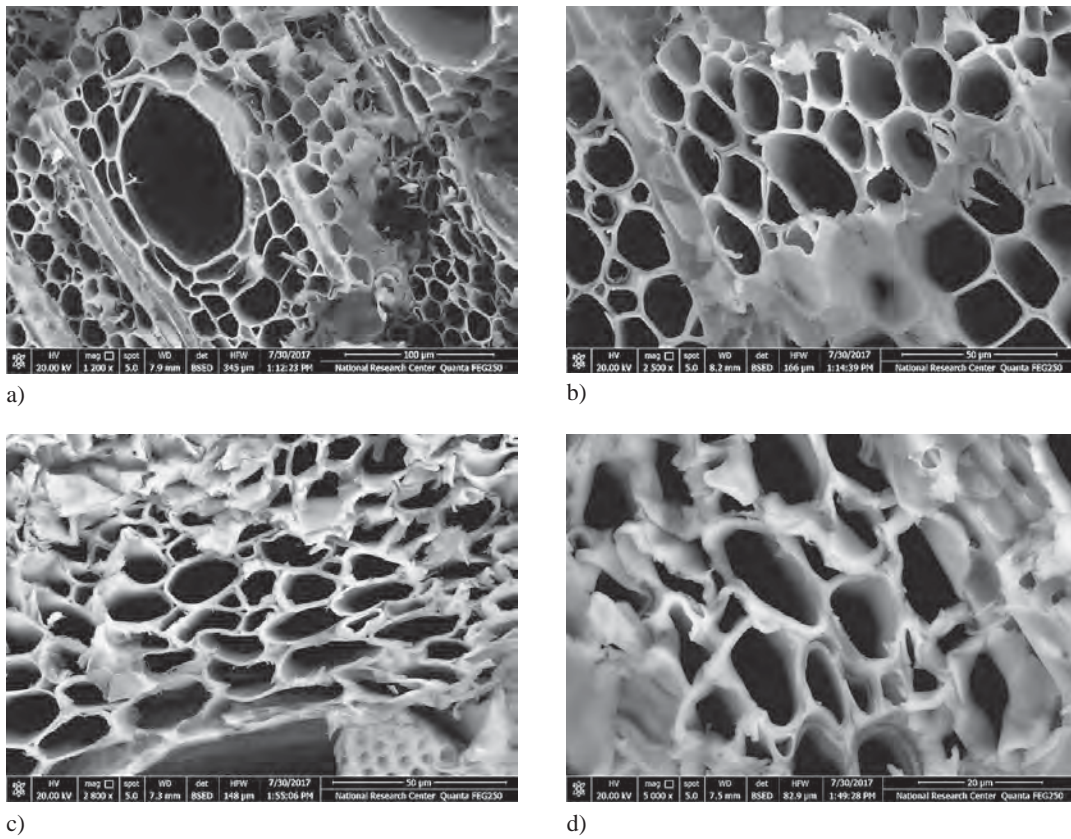

**Figure 3** SEM micrographs of *A. saligna* samples treated with *O. majorana* oil, a, b - treated by spraying; c, d - treated by immersion

**Slika 3.** SEM mikrografije uzoraka drva *A. saligna* obradenih uljem drva *O. majorana* (a, b – obradeni štrcanjem; c, d – obradeni uranjanjem)

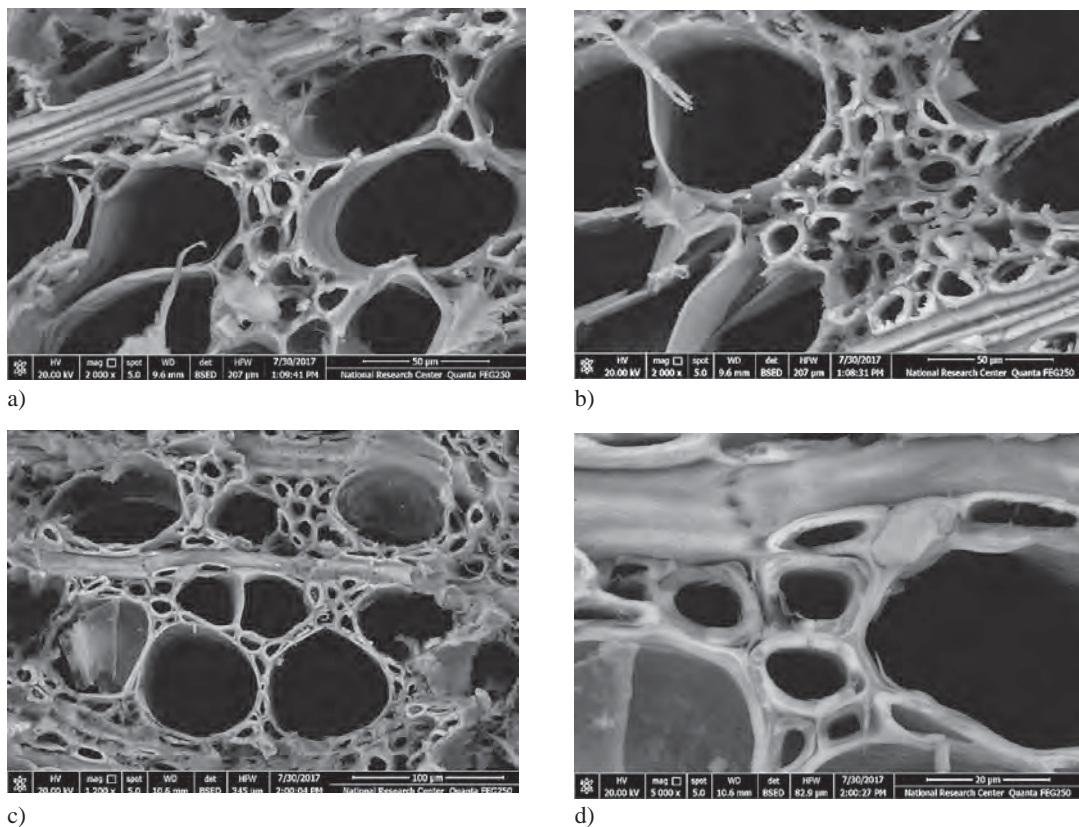

**Figure 4** SEM micrographs of *F. sylvatica* samples treated with *O. majorana* oil, a, b - treated by spraying; c, d - treated by immersion

**Slika 4.** SEM mikrografije uzoraka drva *F. sylvatica* obradenih uljem drva *O. majorana* (a, b – obradeni štrcanjem; c, d – obradeni uranjanjem)

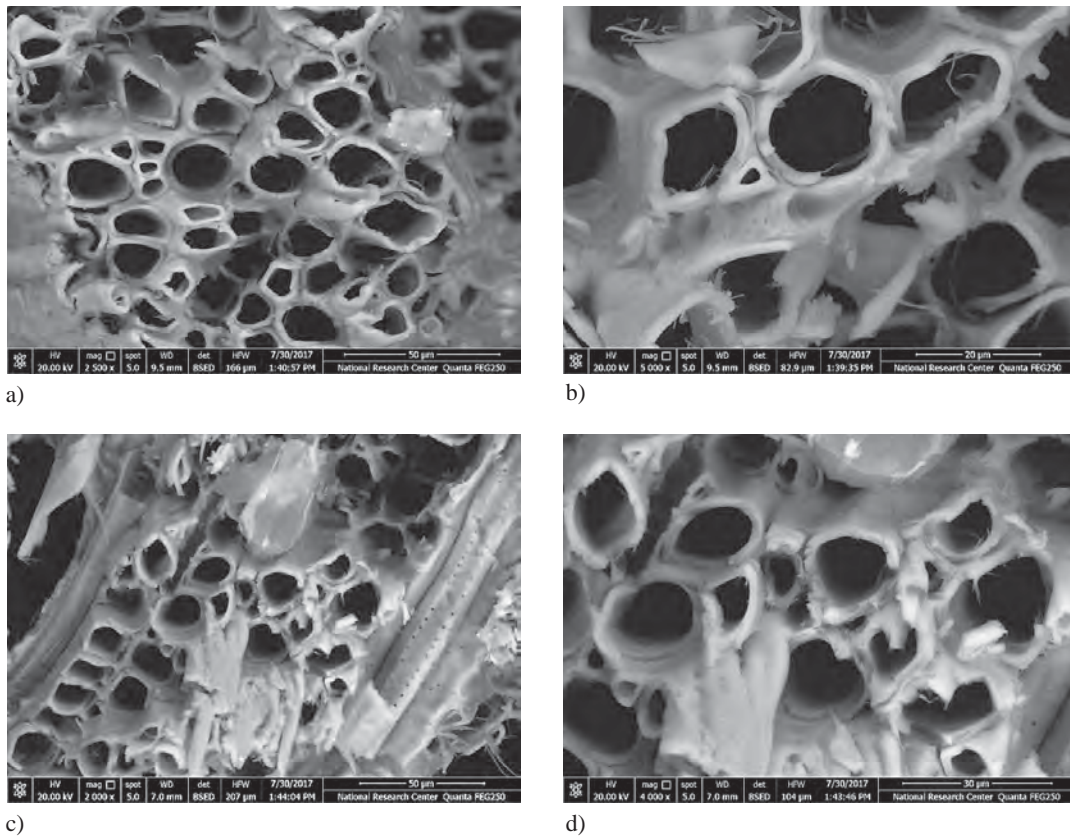

**Figure 5** SEM micrographs of *J. nigra* samples treated with *O. majorana* oil, a, b - treated by spraying; c, d - treated by immersion

**Slika 5.** SEM mikrografije uzoraka drva *J. nigra* obradenih uljem drva *O. majorana* (a, b – obradeni štrcanjem; c, d – obradeni uranjanjem)

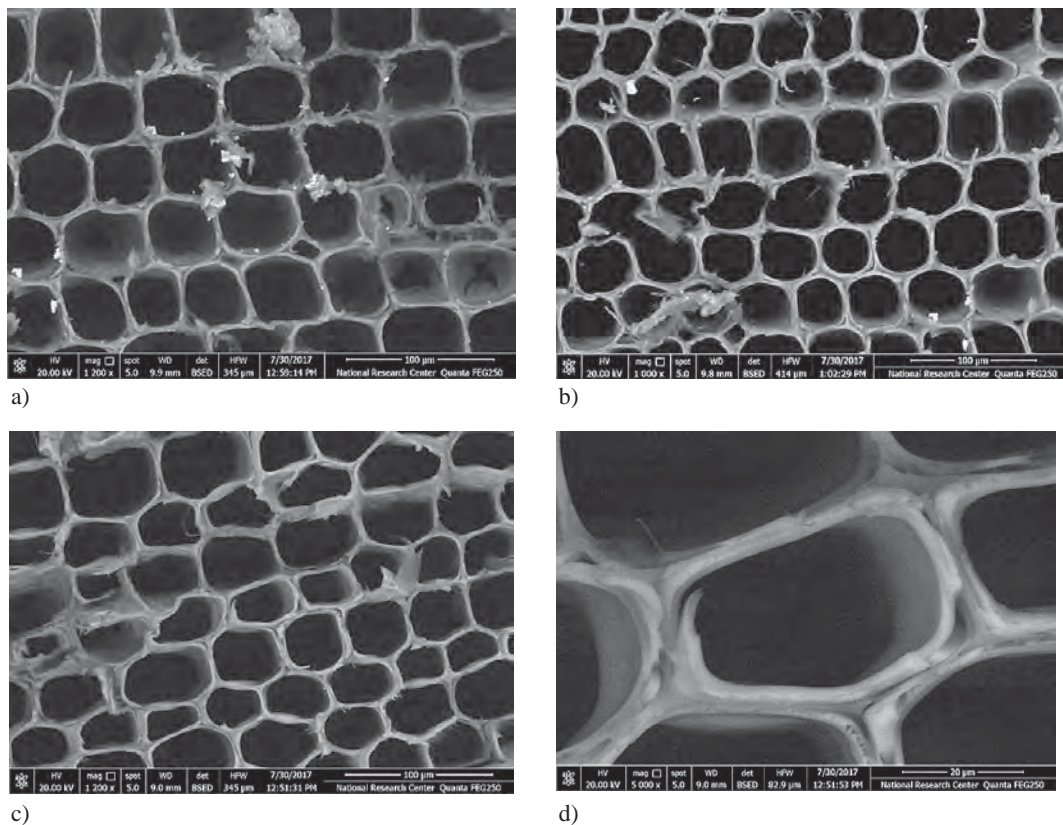

**Figure 6** SEM micrographs of *P. rigida* samples treated with *O. majorana* oil, a, b - treated by spraying; c, d - treated by immersion

**Slika 6.** SEM mikrografije uzoraka drva *P. rigida* obradenih uljem drva *O. majorana* (a, b – obradeni štrcanjem; c, d – obradeni uranjanjem)



## 5 REFERENCES

### 5. LITERATURA

- Al-Asmari, A. K.; Athar, M. T.; Al-Faraidy, A. A.; Almuhaiza, M. S., 2017: Chemical composition of essential oil of *Thymus vulgaris* collected from Saudi Arabian market. *Asian Pacific Journal of Tropical Biomedicine*, 7 (2): 147-150. <https://doi.org/10.1016/j.apjtb.2016.11.023>.
- Al-Huqail, A. A.; Behiry, S. I.; Salem, M. Z. M.; Ali, H. M.; Siddiqui, M. H.; Salem, A. Z. M., 2019: Antifungal, antibacterial, and antioxidant activities of *Acacia saligna* (Labill.) H. L. Wendl. flower extract: HPLC analysis of phenolic and flavonoid compounds. *Molecules*, 24(4): 700. <https://doi.org/10.3390/molecules24040700>.
- Arslan, M.; Dervis, S.; 2010: Antifungal activity of essential oils against three vegetative-compatibility groups of *Verticillium dahlia*. *World Journal of Microbiology and Biotechnology*, 26 (10): 1813-1821. <https://doi.org/10.1007/s11274-010-0362-2>.
- Ballester-Costa, C.; Sendra, E.; Fernández-López, J.; Pérez-Álvarez, J. A.; Viuda-Martos, M., 2013: Chemical composition and *in vitro* antibacterial properties of essential oils of four *Thymus* species from organic growth. *Industrial Crops and Products*, 50 (10): 304-311. <https://doi.org/10.1016/j.indcrop.2013.07.052>.
- Behiry, S. I.; Okla, M. K.; Alamri, S. A.; EL-Hefny, M.; Salem, M. Z. M.; Alaraidh, I. A.; Ali, H. M.; Al-Ghtani, S. M.; Monroy, J. C.; Salem, A. Z. M., 2019: Antifungal and antibacterial activities of *Musa paradisiaca* L. peel extract: HPLC analysis of phenolic and flavonoid contents. *Processes*, 7 (4): 215. <https://doi.org/10.3390/pr7040215>.
- Blanchette, R. A.; Farrell, R. L.; Burnes, T. A., 1992: Biological control of pitch in pulp & paper production by *Ophiostoma piliferum*. *Tappi*, 75: 102-106.
- Braga, F. G.; Bouzada, M. L.; Fabri, R. L.; de O Matos, M.; Moreira, F. O.; Scio, E.; Coimbra, E. S., 2007: Antileishmanial and antifungal activity of plants used in traditional medicine in Brazil. *Journal of Ethnopharmacology*, 111 (2): 396-402. <https://doi.org/10.1016/j.jep.2006.12.006>.
- Breuil, C., 1998: Wood as a nutritional resource for staining fungi. In: *Biology and Prevention of Sapstain*. Forest Products Society, Madison, pp. 1-6.
- Busatta, C.; Vidala, R. S.; Popiolskia, A. S.; Mossia, A. J.; Dariva, C.; Rodrigues, M. R. A.; Corazza, F. C.; Corazza, M. L.; Oliveira J. V.; Cansiana, R. L., 2008: Application of *Origanum majorana* L. essential oil as an antimicrobial agent in sausage. *Food Microbiology*, 25 (1): 207-211. <https://doi.org/10.1016/j.fm.2007.07.003>.
- Daniel, G., 2003: Microview of wood under degradation by bacteria and fungi. In *Proceedings of ACS Symposium Series 845: Wood deterioration and Preservation*, Goodell, B.; Nicholas, D. D.; Schultz, T. P. (eds.), Washington DC, USA, pp. 34-72.
- De Angelis, M.; Romagnoli, M.; Vek, V.; Poljanšek, I.; Oven, P.; Thaler, N.; Lesar, B.; Kržišnik, D.; Humar, M., 2018: Chemical composition and resistance of Italian stone pine (*Pinus pinea* L.) wood against fungal decay and wetting. *Industrial Crops and Products*, 117: 187-196. <https://doi.org/10.1016/j.indcrop.2018.03.016>.
- Domsch, K. H.; Gams, W.; Anderson, T. H., 2007: *Compendium of Soil Fungi*, second ed. IHW-Verlag, Eching, Germany. Taxonomically revised by W. Gams.
- Fabbri, A. A.; Ricelli, A.; Brasini, S.; Fanelli, C., 1997: Effect of different antifungals on the control of paper biodegradation caused by fungi. *International Biodeterioration & Biodegradation*, 39 (1): 61-65. [https://doi.org/10.1016/S0964-8305\(97\)00001-2](https://doi.org/10.1016/S0964-8305(97)00001-2).
- Fazio, A. T.; Papinutti, L.; Gómez, B. A.; Parera, S. D.; Rodríguez Romero, A.; Siracusano, A. G.; Maier, M. S., 2010: Fungal deterioration of a Jesuit South American polychrome wood sculpture. *International Biodeterioration & Biodegradation*, 64 (8): 694-701. <https://doi.org/10.1016/j.ibiod.2010.04.012>.
- Ferraz, A. U.; Baeza, J.; Rodriguez, J.; Freer, J.; 2000: Estimating the chemical composition of biodegraded pine and eucalyptus wood by DRIFT spectroscopy and multivariate analysis. *Bioresource Technology*, 74 (3): 201-212. [https://doi.org/10.1016/S0960-8524\(00\)00024-9](https://doi.org/10.1016/S0960-8524(00)00024-9).
- George, W., 1995: *Hand Book of Material Weathering*, 2<sup>nd</sup> ed. Chem Tec, Ontario, Canada.
- Ghosh, S. C.; Mai, C.; Militz, H., 2008: The Efficacy of Commercial Silicones against Blue Stain and Mould Fungi in Wood. *The International Research Group on Wood Protection (Istanbul, Turkey)*, IRG/WP 08-30471, 17 p.
- Goktas, O.; Baysal, E.; Ozen, E.; Mammadov, R.; Duru, M. E., 2008: Decay resistance and color stability of wood treated with *Juglans regia* extract. *Wood Research*, 53(3): 27-36.
- Ibrahim, F. A.; Bellail, A. A.; Hamad, A. M.; Mecherar-Idjeri, S., 2017: Antimicrobial Activities and chemical composition of the essential oil of *Origanum majorana* L. growing in Libya. *Ijppr. Human*, 8 (3): 1-11.
- Imelouane, B.; Amhamdi, H.; Wathélet, J. P.; Ankit, M.; Khedid, K.; El-Bachiri, A., 2009: Chemical composition and antimicrobial activity of essential oil of thyme (*Thymus vulgaris*) from eastern Morocco. *International Journal of Agriculture and Biology*, 11 (2): 205-208.
- Jeloková, E.; Šindler, J., 1997: Influence of beech and acacia wood extractives on activity of wood-destroying fungi. In *Proceedings of 1<sup>st</sup> Symposium e Drevoznehodnocující huby*, 97, 133-139. TU Zvolen.
- Jeloková, E.; Šindler, J., 2001: Testing of some chemical compounds for wood protection. *Drevo*, 56: 137-138.
- Johann, S.; Cisalpino, P. S.; Watanabe, G. A.; Cota, B. B.; de Siqueira, E. P.; Pizzolatti, M. G.; Zani, C. L.; de Resende, M. A., 2010: Antifungal activity of extracts of some plants used in Brazilian traditional medicine against the pathogenic fungus *Paracoccidioides brasiliensis*. *Pharmaceutical Biology*, 48 (4): 388-396. <https://doi.org/10.3109/13880200903150385>.
- Kassem, M. E. S.; El-Desoky, S. K.; Sharaf, M., 2004: Biphenyl esters and bioflavonoids from the fruits of *Schinus terebinthifolius*. *Chemistry of Natural Compounds*, 40 (5): 447-450. <https://doi.org/10.1007/s10600-005-0008-z>.
- Kerner-Gang, W.; Schneider, R., 1969: Von optischen Gläsern isolierte Schimmelpilze. *Mater. Org.* 4: 281-296.
- Kim, J.-J.; Kang, S.-M.; Choi, Y.-S.; Kim, G.-H., 2007: Microfungi potentially disfiguring CCA-treated wood. *International Biodeterioration & Biodegradation*, 60 (3): 197-201. <https://doi.org/10.1016/j.ibiod.2007.05.002>.
- Kiran, B.; Raveesha, K. A., 2006: Antifungal activity of seed extract of *Psoralea corylifolia* L. *Research in Plant Disease*, 20: 213-215.
- Kumar, A.; Shukla, R.; Singh, P.; Prasad, C. S.; Dubey, N. K., 2008: Assessment of *Thymus vulgaris* L. essential oil as a safe botanical preservative against post-harvest fungal infestation of food commodities. *Innovative Food Science and Emerging Technologies*, 9 (4): 575-580. <https://doi.org/10.1016/j.ifset.2007.12.005>.
- Lakhrissi, B.; Boukhraz, A.; Barrahi, M.; Hartiti, H. E. L.; Ouhssine, M., 2016: Antifungal activity of essential oil of Oregano (*Origanum Vulgare*), Marjoram (*Origa-*

- num Majorana*) and synergy of two essential oils against *Candida albicans*. International Journal of Innovative Research in Science, Engineering and Technology 3 (12): 14-17.
30. Li, Q.; Lin, J.-G.; Liu, J., 2013: Decay resistance of wood treated with extracts of *Cinnamomum camphora* xylem. BioResources, 8 (3): 4208-4217.
  31. Lima, M. R. F.; Luna, J. S.; Santos, A. F.; Andrade, M. C. C.; Sant'ana, A. E. G.; Genet, J. P.; Marquez, B.; Neuville, L.; Moreau, N., 2006: Anti-bacterial activity of some Brazilian medicinal plants. Journal of Ethnopharmacology, 105 (1-2): 137-147. <https://doi.org/10.1016/j.jep.2005.10.026>.
  32. Ljaljević Grbić, M.; Stupar, M.; Vukojević, J.; Maričić, I.; Bungur, N., 2013: Molds in museum environments: biodeterioration of art photographs and wooden sculptures. Archives of Biological Science Belgrade, 65(3): 955-962. <https://doi.org/10.2298/ABS1303955G>.
  33. Lloyd, H. A.; Jaouni, T. M.; Evans, S. L.; Morton, J. F., 1977: Terpenes of *Schinus terebinthifolius*. Phytochemistry, 16: 1301-1302.
  34. Mansour, M. M.; Salem, M. Z. M., 2015: Evaluation of wood treated with some natural extracts and Paraloid B-72 against the fungus *Trichoderma harzianum*: wood elemental composition, in-vitro and application evidence. International Biodeterioration & Biodegradation, 100 (5): 62-69. <https://doi.org/10.1016/j.ibiod.2015.02.009>.
  35. Mansour, M. M. A.; Salem, M. Z. M.; Khamis, M. H.; Ali, H. M., 2015a: Natural durability of *Citharexylum spinosum* and *Morus alba* woods against three mold fungi. BioResources, 10 (3): 5330-5344.
  36. Mesquita, N.; Portugal, A.; Videira, S.; Rodríguez-Echverría, S.; Bandeira, A. M. L.; Santos, M. J. A.; Freitas, H., 2009: Fungal diversity in ancient documents. A case study on the archive of the University of Coimbra. International Biodeterioration & Biodegradation, 63 (5): 626-629. <https://doi.org/10.1016/j.ibiod.2009.03.010>.
  37. Mohamed, W. A.; Mansour, M. M. A.; Salem, M. Z. M., 2019: *Lemna gibba* and *Eichhornia crassipes* extracts: clean alternatives for deacidification, antioxidation and fungicidal treatment of historical paper. Journal of Cleaner Production, 219: 846-855. <https://doi.org/10.1016/j.jclepro.2019.02.097>.
  38. Nikolić, M.; Glamočlija, J.; Ferreira, I. C. F. R., Calhela R. C.; Fernandes, Â.; Marković, T.; Marković, D.; Giveli, A.; Soković, M., 2014: Chemical composition, antimicrobial, antioxidant and antitumor activity of *Thymus serpyllum* L., *Thymus algeriensis* Boiss. and Reut and *Thymus vulgaris* L. essential oils. Industrial Crops and Products, 52 (1): 183-190. <https://doi.org/10.1016/j.indcrop.2013.10.006>.
  39. NIST/EPA/NIH Mass Spectral Library (NIST 11) and NIST Mass Spectral Search Program (Version 2.0g), May 2011.
  40. Oberacher, H., 2011: Wiley Registry of Tandem Mass Spectral Data, MSforID. Hoboken: John Wiley & Sons Inc., 2011.
  41. Obanda, D. N.; Shupe, T. F.; Catallo, W. J., 2008: Resistance of *Trichoderma harzianum* to the biocide tebuconazole – proposed biodegradation pathways. Holzforschung, 62 (5): 613-619. <https://doi.org/10.1515/HF.2008.098>.
  42. Owen, J. A.; Owen, N. L.; Feist, W. C., 1993: Scanning electron microscope and infrared studies of weathering in southern pine. Journal of Molecular Structure, 300: 105-114. [https://doi.org/10.1016/0022-2860\(93\)87010-7](https://doi.org/10.1016/0022-2860(93)87010-7).
  43. Pandey, K. K.; Pitman, A. J., 2003: FTIR studies of the changes in wood chemistry following decay by brown-rot and white-rot fungi. International Biodeterioration & Biodegradation, 52: 151-160. [https://doi.org/10.1016/S0964-8305\(03\)00052-0](https://doi.org/10.1016/S0964-8305(03)00052-0).
  44. Philp, R. W.; Bruce, A.; Munro, A. G., 1995: The effect of water soluble scats pine (*Pinus sylvestris* L.) and Sitka Spruce [*Picea sitchensis* (Bong.) Cam] heartwood and sapwood extracts on the growth of selected *Trichoderma* species. International Biodeterioration & Biodegradation, 35 (5): 355-367. [https://doi.org/10.1016/0964-8305\(95\)00053-9](https://doi.org/10.1016/0964-8305(95)00053-9).
  45. Qi, W.; Jellison, J., 2004: Characterization of a transplasma membrane redox system of the brown rot fungus *Gloeophyllum trabeum*. International Biodeterioration & Biodegradation, 53 (1): 37-42. <https://doi.org/10.1016/j.ibiod.2003.09.002>.
  46. Ramos, S.; Rojas, L. B.; Lucena, M. E.; Meccia, G.; Usubillaga, A., 2011: Chemical composition and antibacterial activity of *Origanum majorana* L. essential oil from the Venezuelan Andes. Journal of Essential Oil Research, 23 (5): 45-49. <https://doi.org/10.1080/10412905.2011.9700481>.
  47. Rus, C. F.; Pop, G.; Alexa, E.; Şumălan, R. M.; Copolovici, D. M. M., 2015: Antifungal activity and chemical composition of *Origanum majorana* L. essential oil. Research Journal of Agriculture and Biological Sciences, 47 (2): 179-185.
  48. Salem, M. Z. M., 2016: EDX measurements and SEM examination of surface of some imported woods inoculated by three mold fungi. Measurement, 86 (5): 301-309. <https://doi.org/10.1016/j.measurement.2016.03.008>.
  49. Salem, M. Z. M.; Mansour, M. M. A.; Mohamed, W. S.; Ali, H. M.; Hatamleh, A. A., 2017: Evaluation of the antifungal activity of treated *Acacia saligna* wood with Paraloid B-72/TiO<sub>2</sub> nanocomposites against the growth of *Alternaria tenuissima*, *Trichoderma harzianum*, and *Fusarium culmorum*. BioResources, 12 (4): 7615-7627.
  50. Salem, M. Z. M.; Zidan, Y. E.; Mansour, M. M. A.; El Hadidi, N. M. N.; Abo Elgat, W. A. A., 2016a: Antifungal activities of two essential oils used in the treatment of three commercial woods deteriorated by five common mold fungi. International Biodeterioration & Biodegradation, 106 (1): 88-96. <https://doi.org/10.1016/j.ibiod.2015.10.010>.
  51. Salem, M. Z. M.; Zidan, Y. E.; Mansour, M. M. A.; El Hadidi, N. M. N.; Abo Elgat, W. A. A., 2016b: Evaluation of usage three natural extracts applied to three commercial wood species against five common molds. International Biodeterioration & Biodegradation, 110 (5): 206-226. <https://doi.org/10.1016/j.ibiod.2016.03.028>.
  52. Salem, M. Z. M.; Zayed, M. Z.; Ali, H. M.; Abd El-Kareem, M. S. M., 2016c: Chemical composition, antioxidant and antibacterial activities of extracts from *Schinus molle* L. wood branch growing in Egypt. Journal of Wood Science, 62 (6): 548-561. <https://doi.org/10.1007/s10086-016-1583-2>.
  53. Salem, M. Z. M.; Ali, H. M.; El-Shanhorey, N. A.; Abdel-Megeed, A., 2013: Evaluation of extracts and essential oil from *Callistemon viminalis* leaves: antibacterial and antioxidant activities, total phenolic and flavonoid contents. Asian Pacific Journal of Tropical Medicine, 6 (10): 785-791. [https://doi.org/10.1016/S1995-7645\(13\)60139-X](https://doi.org/10.1016/S1995-7645(13)60139-X).
  54. Salem, M. Z. M.; EL-Hefny, M.; Ali, H. M.; Elansary, H. O.; Nasser, R. A.; El-Settawy, A. A. A.; El Shanhorey, N.; Ashmawy, N. A.; Salem, A. Z. M., 2018: Antibacterial activity of extracted bioactive molecules of *Schinus ter-*

- ebinthifolius* ripened fruits against some pathogenic bacteria. Microbial Pathogenesis, 120 (7): 119-127. <https://doi.org/10.1016/j.micpath.2018.04.040>.
55. Salem, M. Z. M.; Behiry, S. I.; EL-Hefny, M., 2019b: Inhibition of *Fusarium culmorum*, *Penicillium chrysogenum* and *Rhizoctonia solani* by n-hexane extracts of three plant species as a wood-treated oil fungicide. Journal of Applied Microbiology, 126 (6): 1683-1699. <https://doi.org/10.1111/jam.14256>.
  56. Salem, M. Z. M.; Mansour, M. M. A.; Elansary, H. O., 2019b. Evaluation of the effect of inner and outer bark extracts of Sugar Maple (*Acer saccharum* var. *saccharum*) in combination with citric acid against the growth of three common molds. Journal of Wood Chemistry and Technology, 39 (2): 136-147. <https://doi.org/10.1080/02773813.2018.1547763>.
  57. Schmidt, O., 2006: Wood and Tree Fungi: Biology, Damage, Protection and Use. Springer-Verlag, Berlin, Germany.
  58. Schmourlo, G.; Mendonça-Filho, R. R.; Alviano, C. S.; Costa, S. S., 2005: Screening of antifungal agents using ethanol precipitation and bioautography of medicinal and food plants. Journal of Ethnopharmacology, 96 (3): 563-568. <https://doi.org/10.1016/j.jep.2004.10.007>.
  59. Sun, X. F.; Xu, F.; Sun, R. C.; Fowler, P.; Baird, M. S., 2005: Characteristics of degraded cellulose obtained from steam-exploded wheat straw. Carbohydrate Research, 340 (1): 97-106. <https://doi.org/10.1016/j.carres.2004.10.022>.
  60. Strzelczyk, A. B.; Kuroczkin, J.; Krumbein, W. E., 1987: Studies on the microbial degradation of ancient leather bookbindings. Part 2. International Biodeterioration, 23 (1): 3-27. [https://doi.org/10.1016/0265-3036\(87\)90039-X](https://doi.org/10.1016/0265-3036(87)90039-X).
  61. Tolvaj, L., 2009: Monitoring of photodegradation for wood by infrared spectroscopy. International Conference on Wooden Cultural Heritage: Evaluation of Deterioration and Management of Change (Hamburg/Germany). <http://real.mtak.hu/24589/>.
  62. Van Meel, P. A.; Erich, S. J. F.; Huinink, H. P.; Kopinga K.; De Jong, J.; Adan, O. C. G., 2011: Moisture transport in coated wood. Progress in Organic Coatings, 72: 686-694. <https://doi.org/10.1016/j.porgcoat.2011.07.011>.
  63. Vera, R. R.; Chane-Ming, J., 1999: Chemical composition of the essential oil of marjoram (*Origanum majorana* L.) from Reunion Island. Food Chemistry, 66 (2): 143-145. [https://doi.org/10.1016/S0308-8146\(98\)00018-1](https://doi.org/10.1016/S0308-8146(98)00018-1).
  64. Verma, J.; Dubey, N. K., 1999: Prospectives of botanical and microbial products as pesticides of tomorrow. Current Science, 76: 172-179.
  65. Viitanen, H.; Ritschkoff, A.-C., 1991: Mould Growth in Pine and Spruce Sapwood in Relation to Air Humidity and Temperature. Swed. Univ. Agric. Sci. Dept. Forest Prod., Uppsala-Sweden. Report No. 221.
  66. Viuda-Martos, M.; El Gendy, A. E.; Sendra, E.; Fernández-López, J.; El Razik, K. A. A.; Omer, E. A.; Pérez-Alvarez, J. A., 2010: Chemical composition and antioxidant and anti-Listeria activities of essential oils obtained from some Egyptian plants. Journal of Agricultural and Food Chemistry, 58 (16): 9063-9070. <https://doi.org/10.1021/jf101620c>.
  67. Wang, C. J. K.; Zabel, R. A. (eds.), 1990: Identification Manual for Fungi from Utility Poles in the Eastern United States. Allen Press, Lawrence, Kansas.
  68. Wang, S. Y.; Chen, P. F.; Chang, S. T., 2005: Antifungal activities of essential oils and their constituents from indigenous cinnamon (*Cinnamomum osmophloeum*) leaves against wood decay fungi. Bioresource Technology, 96 (7): 813-818. <https://doi.org/10.1016/j.biortech.2004.07.010>.
  69. Xu, K.; Feng, J.; Zhong, T.; Zheng, Z.; Chen, T., 2015: Effects of volatile chemical components of wood species on mould growth susceptibility and termite attack resistance of wood plastic composites. International Biodeterioration & Biodegradation, 100 (5): 106-115. <https://doi.org/10.1016/j.ibiod.2015.02.002>.
  70. Zabel, R. A.; Morrell, J. J., 1992: Wood Microbiology Decay and Its Prevention. Academic Press, London.
  71. Žlahtič, M.; Humar, M., 2017: Influence of Artificial and Natural Weathering on the Moisture Dynamic of Wood. BioResources, 12 (1): 117-142. <https://doi.org/10.15376/biores.12.1.117-142>.

**Corresponding address:**

Assoc. Prof. MOHAMED Z. M. SALEM, Ph.D.

Alexandria University  
Forestry and Wood Technology Department  
Faculty of Agriculture (EL-Shatby)  
Alexandria, EGYPT  
e-mail: Mohamed-salem@alexu.edu.eg

# Impact of Heat Treatment on the Quality of Tree-of-Heaven Wood

## Utjecaj toplinske modifikacije na kvalitetu drva pajasena

### Original scientific paper • Izvorni znanstveni rad

Received – prispjelo: 12. 9. 2018.

Accepted – prihvaćeno: 20. 11. 2019.

UDK: 630\*812.22; 630\*812.23; 630\*812.71; 630\*812.72

<https://doi.org/10.5552/drvind.2019.1842>

**ABSTRACT** • *Ailanthus altissima* (Miller) Swingle is a deciduous, fast-growing species that can tolerate extreme climatic conditions and is particularly invasive. In the framework of climate change, and the imperative need for carbon greenhouse gases sequestration, this species could acquire increasing importance through its utilization in the construction of wood based products and structures, due to its satisfying properties combined with its fast growth. This study determines for the first time the influence of thermal treatment, under different conditions (190 °C, 210 °C, 230 °C for 2 hours), on some crucial physical, hygroscopic and mechanical properties of wood, in an attempt to improve its intense hygroscopic nature and not so desirable colour. Thermal treatment affected the dimensional stability and water absorbing capacity of wood in a positive way, decreasing EMC, swelling (tangential–radial) and adsorption percent, compared to untreated wood. The anisotropy of wood was decreased only to a small extent. The total surface colour differences ( $\Delta E^*$ ), prior and after treatment, ranged between 0.48 and 54.57, and appeared to be well correlated with treatment temperature. Only the most intensive treatment influenced negatively the modulus of rupture and impact bending strength of wood, while the elasticity and compression strength of treated wood were proved to be similar to those of untreated wood. Tree-of-heaven could benefit from a mild or medium intensity heat treatment process, in order to be modified to an aesthetically pleasing wood with enhanced hygroscopic nature and properties, facilitating its use in cabinetry and in variable indoor and outdoor non-structural applications.

**Keywords:** *Ailanthus*, colour, hygroscopic properties, mechanical strength, thermal treatment

**SAŽETAK** • *Ailanthus altissima* (Miller) Swingle listopadna je, brzorastuća i invazivna vrsta drva koja je otporna na ekstremne klimatske uvjete. S gledišta klimatskih promjena i nužne potrebe za sekvencijom stakleničkih plinova, ta bi vrsta drva zbog svojih svojstava, u kombinaciji s brzim rastom, mogla steći sve veće značenje u graditeljstvu. Ovim se istraživanjem prvi put utvrđuje utjecaj toplinske modifikacije pri različitim temperaturama na ključna fizička i mehanička svojstva drva radi smanjenja njegove higroskopnosti i dobivanja poželjnije boje. Toplinska modifikacija pozitivno je utjecala na dimenzijsku stabilnost te na smanjenje upijanja vode, ravnotežnog sadržaja vode, bubrenja (tangencijalno – radijalno) i adsorpcije u usporedbi s nemodificiranim drvom. Anizotropnost drva samo se neznatno smanjila. Ukupna promjena boje ( $\Delta E^*$ ) površine drva prije i nakon toplinske modifikacije bila je u rasponu od 0,48 do 54,57 i pokazala je dobru korelaciju s temperaturom modifikacije. Samo je modifikacija s najvišom temperaturom negativno utjecala na modul loma i čvrstoću na udar, dok su elastičnost i čvrstoća na

<sup>1</sup> Authors are researchers at Aristotle University of Thessaloniki, Faculty of Forestry and Natural Environment, Department of Harvesting and Technology of Forest Products, Thessaloniki, Greece.

<sup>1</sup> Autori su istraživači Sveučilišta Aristotel u Solunu, Fakultet za šumarstvo i okoliš, Zavod za sječu šuma i tehnologiju u šumarstvu, Solun, Grčka.

*vlak toplinski modificiranog drva bili podjednaki kao i nemodificiranog drva. Slab ili umjeren postupak toplinske modifikacije može modificirati drvo pajasena u estetski ugodno drvo poboljšanih svojstava i smanjene higroskopsnosti te time olakšati i proširiti njegovu uporabu u proizvodnji namještaja i nenosivih elemenata u graditeljstvu.*

**Ključne riječi:** *Ailantus*, boja, higroskopsnost, čvrstoća, toplinska modifikacija

## 1 INTRODUCTION

### 1. UVOD

*Ailanthus altissima* (Miller) Swingle is a deciduous tree in the principally tropical *Quassia* family, the one of *Simaroubaceae*. The genus is native from eastern Asia south to northern Australasia. It was introduced in Europe in the 1700s and has become widespread there. Widely known as tree-of-heaven, this species constitutes a prolific seed producer, a persistent stump and root sprouter, and an aggressive competitor with respect to the surrounding vegetation. It grows primarily in disturbed areas, though it may also invade undisturbed habitats, and it prefers warm or moderately warm climate areas. In contrast to other species, it can survive in summer on extremely dry gravel sites, thanks to its ability to reduce considerably the daily transpiration and thanks to rapid transport of water from roots to assimilatory organs (Kudela and Mamonova, 2006).

Tree-of-heaven is a fast growing species with an annual growth ring of 7.75 mm, while its basic density is about 0.55 g/cm<sup>3</sup> (Barboutis and Vasileiou, 2009). Especially, the young plants grow unusually fast in height, and the older ones increase noticeably in girth (Hu, 1970). Moreover, it constitutes the second most important timber species in China, since it derives straight stems up to 20 m producing a widely applicable and of high quality timber, given that a strong forest management encouragement and utilization take place. Its stem diameter can naturally reach up to 1 m and it is mainly knot free with characteristic lengthwise white cracked bark and a medium extended diameter crown of 8-12 m (Brandner and Schickhofer, 2010). It is planted for timber and afforestation purposes also in New Zealand, Middle East, Eastern Europe, South America and other areas.

Tree-of-heaven wood is yellowish white and especially the wood of mature trees is of high quality for cabinet work, musical instruments and other types of woodenware (Kumar *et al.* 2010). This species of wood is easily worked with tools and acts as a good substrate for finishes and adhesives. Although the living tree tends to have quite flexible wood, it gets quite hard being properly dried, and the strength of this wood offers the ability to be used in the construction of a wide variety of wooden structures (Barboutis and Vasileiou, 2009).

The previous studies in literature mainly focus on the invasiveness of tree-of-heaven and control methods of its spread, whereas there is a lack of information and quantitative data on wood properties of this species. Specifically, Moslemi and Bhagwat (1970) examined some physical and mechanical properties of ailanthus, concluding that it is not suitable for use in heavy structural applications where high mechanical strength is

required, but that it could be used in the construction of lighter structures, furniture, shipbuilding, decorative applications, matches, pallets and as firewood. They also concluded that this species is suitable for use in pulp and paper production and in fibreboards and particleboards with satisfying results. Demirbas (2001) studied its chemical composition and calorific value. The results of an investigation of *Ailanthus* wood properties in Bulgaria have shown that tree-of-heaven is an underestimated species that can be successfully used in the production of paper, and furniture; in combination with its pharmaceutical value, it could be considered to be a precious resource, a low cost raw material and appropriate for establishing pilot experimental plantations (Panayotov *et al.*, 2011, Kozuharova *et al.*, 2014). In one of our previous work (Barboutis and Kamperidou, 2017), wood of *Ailanthus* grown in Greece revealed quite satisfying properties, recording slightly higher modulus of rupture and axial compression strength and generally similar mechanical strength properties compared to the properties of tree-of-heaven of different origins published in the researches of Panayotov *et al.* (2011) and Kozuharova *et al.* (2014). Additionally, the properties of ailanthus were found to be similar to those of other hardwood species of medium density, such as chestnut wood. It was also found that tree-of-heaven could be utilized in the construction of plywood panels of satisfying quality and appearance, as well as the production of pellets of ENplus A1 category (Barboutis and Vasileiou, 2009). The appearance of tree-of-heaven wood is similar to that of ash wood, while the wood is classified among species of medium natural durability against the action of wood decay fungi (Barboutis and Vasileiou, 2009).

On the other hand, tree-of-heaven wood is also characterised by some problematic properties, such as low water resistance and dimensional stability, as it is a fast growing species that contains a high amount of water adapted to grow in extreme dry conditions (Kudela and Mamonova, 2006) and additionally, possesses non delightful colour and texture, unfavourable features that limit its range of applications.

One of the wood modification methods, developed in order to improve these disadvantageous properties of wood species of similar characteristics, is thermal treatment that changes most of the physical, chemical and mechanical properties of wood. The improvement of the behaviour and properties of wood by heat treatment is attributed to the alteration of wood cell wall polymers (hemicelluloses, cellulose, lignin, extractives) and its chemical synthesis. Specifically, wood treated under high temperatures loses its reabsorbing water capacity, demonstrates enhanced dimensional stability and most of the times higher biological

durability, while the colour of wood tends to darken, attaching additional aesthetic value to the material. As the treatment intensity increases, some of the mechanical properties of wood may deteriorate, thus the conditions of the treatment should be specified after careful consideration, in order to achieve the appropriate material performance for each application.

Many researches regarding properties of several thermally modified hardwood species, such as poplar wood (Wikberg and Maunu, 2004; Olek and Bonarski, 2008; Kocaefe *et al.*, 2008 etc.), acacia wood (Tuong and Li 2010; Yao, 2010 etc.), oak wood (Wikberg and Maunu, 2004 etc.), eucalyptus wood (Esteves, 2007 etc.), beech wood (Hakkou *et al.*, 2006; Bächle *et al.*, 2010 etc.), chestnut wood (Ates *et al.*, 2010 etc.) have been published so far, but as found in the literature, there is no information about the behaviour and properties of tree-of-heaven wood after heat treatment.

Therefore, the objective of the present study is to determine the influence of heat treatment at different temperature levels (190 °C, 210 °C and 230 °C) for the short duration of 2 hours, on the weight, dimensions, equilibrium moisture content (*EMC*), dimensional stability (adsorption and swelling), colour and the mechanical properties of tree-of-heaven wood, in order to comprehend its response to high temperatures and investigate the potential heat modification to contribute to a more thorough utilization of this species.

## 2 MATERIALS AND METHODS

### 2. MATERIJALI I METODE

Tree-of-heaven (*Ailanthus altissima* (Mill.) Swingle) wood of 4 native trees, obtained from Thessaloniki area (North Greece, botanical garden of University campus in Finikas), aged 11-15 years, was kept in the laboratory at (20±2) °C and (60±5) % relative humidity for about two years to reach a nominal *EMC* of 9.2 %. The *EMC* of the specimens was measured using the standard ISO 3130:1975, based on their constant weight. Afterwards, clear specimens of wood were prepared in dimensions of 2 cm × 2 cm × 37 cm (parallel to grain) for thermal treatment process. At the time of treatment, the mean moisture content of wood was 9.2 % (0.11 standard deviation – SD), while its density (oven-dry mass/volume at 9.2 % moisture content) was measured to be 0.56 g/cm<sup>3</sup> (0.02 SD) (ISO 3131:1975).

Thermal treatments of the specimens were carried out in a temperature controlled laboratory heating unit (40 cm × 28 cm × 28 cm). Three different temperatures (190 °C, 210 °C and 230 °C) were applied under atmospheric pressure, in the presence of air. Thermal treatments of relatively low energy consumption and cost were selected for this research. For this purpose, only simple drying equipment was used in order to make it easily transferable to real conditions for numerous small scale industries that aim at the improvement of fast growing wood species of low quality, especially under the current conditions of economic crisis and shortage of high quality timber. The speci-

mens were placed in the unit after reaching the desired temperature (in groups of 10 specimens). The small decrease of the temperature, caused by the opening of the oven, was reinstated within 5 minutes and the specimens remained in the unit at the desired temperature for 2 hours.

The weight loss (*WL*) (%) after heat treatment was estimated according to the following equation (Eq. 1):

$$WL = \frac{m_o - m_{ht}}{m_o} \cdot 100 \quad (1)$$

Where  $m_o$  is the weight of the specimen, with *EMC* as before thermal treatment;  $m_{ht}$  is the weight of the specimen measured directly after thermal treatment. Weight measurements of the specimens were also made 14 days after thermal treatment, in order to detect the rhythm of reconditioning progress.

All the properties tests were carried out after the reconditioning of the heat treated specimens (at (20±2) °C and (60±5) % relative humidity for 30 days), and the specimens of each test were formed to the final dimensions according to the requirements of the respective standard. For each property tested, at least 10 specimens were prepared, taking only one from each initial board, to ensure the representativeness of the results. *EMC* of treated and untreated specimens was measured after 30 days of reconditioning (ISO 3130:1975).

The swelling (in radial and tangential direction) and adsorption percentage measurements were conducted until treated and untreated specimens reached constant weight (air-dried) after being immersed in water at (20±3) °C for 1 and 6 days, respectively, in accordance with the corresponding standard (ISO 4859:1982) on dimensions and weight measurements.

The properties of bending strength (modulus of rupture – *MOR*) and modulus of elasticity (*MOE*) were carried out on a Universal Testing Machine (SHIMADZU UH-300kNA), where the rate of crosshead-movement was adjusted at 6 mm/min, so that the maximum load was reached within (1.5±0.5) min throughout the test (ISO 3133:1975). The impact bending strength test was carried out on an Amsler Universal Wood Testing machine at 24 cm span with centre loading (ISO 3348:1975), and the compressive strength test (DIN 52185:1976) by adjusting the respective ancillary equipment in the testing machine.

Colour of the specimens was measured using a Minolta Colorimeter Chroma-Meter CR-400, by which the colour change depending on heat treatment was evaluated. According to ASTM D 1536-58 T 1964 standard, the colour coordinates,  $L^*$ ,  $a^*$ , and  $b^*$  of the CIE  $L^*a^*b^*$  system were recorded before and after each thermal treatment at the same points and these parameters were used to calculate the total colour change ( $\Delta E^*$ ) and the Chroma or Saturation ( $C^*$ ), in which 0 represents only greyish colours and 60, for instance, represents very vivid colours and the Saturation Index ( $\Delta C^*$ ).

The test results were grouped and examined by one-way analysis of variance (ANOVA) comparing the differences of means at the 0.05 level, in order to determine significant differences in the effect of the treatment combinations on the properties.

**Table 1** Weight and thickness losses (tangentially-radially) of tree-of-heaven specimens due to treatments and weight and thickness increases after 14 days of conditioning

**Tablica 1.** Gubitak mase i debljine (tangento – radijalno) drva pajasena zbog toplinske modifikacije te povećanje mase i debljine nakon 14 dana kondicioniranja

Treatment <i>Tretman</i>	Weight loss directly after treatment, % <i>Gubitak mase odmah nakon modifikacije, %</i>	Weight increase after 14 days, % <i>Povećanje mase nakon 14 dana, %</i>	Thickness loss tangentially directly after treatment, % <i>Gubitak debljine u tangentnom smjeru nakon modifikacije, %</i>	Thickness increase tangentially after 14 days, % <i>Povećanje debljine u tangentnom smjeru nakon 14 dana, %</i>	Thickness loss radially directly after treatment, % <i>Gubitak debljine u radijalnom smjeru nakon modifikacije, %</i>	Thickness increase radially after 14 days, % <i>Povećanje debljine u radijalnom smjeru nakon 14 dana, %</i>
190 °C	8.44 (0.08)*	5.40 (0.25)	1.72 (0.20)	0.79 (0.16)	0.98 (0.25)	0.59 (0.11)
210 °C	10.00 (0.23)	4.52 (0.20)	2.24 (0.65)	0.85 (0.17)	1.49 (0.40)	0.65 (0.16)
230 °C	21.15 (2.19)	3.54 (0.07)	3.35 (0.61)	0.52 (0.18)	2.68 (0.73)	0.50 (0.17)

\* Numbers in parentheses represent the standard deviation of ten replicates. / Brojevi u zagradama standardne su devijacije deset uzoraka.

### 3 RESULTS AND DISCUSSION 3. REZULTATI I RASPRAVA

According to the results (Table 1), thermal treatments caused a weight loss to the tree-of-heaven specimens, in the range between 8.44 % and 21.15 %, compared to the unmodified wood, and this weight loss, measured immediately after each thermal treatment, was proved to increase relatively with the intensity of the treatment. As the treatment temperature increased, higher weight losses due to treatment process were recorded. In the mildest treatment (190 °C - 2 hours), this loss could be mainly attributed to the release of a part of the moisture content, since moisture evaporates through the wood surface and wood specimens of similar dimensions usually need more than 2 hours to dry completely. It can also be attributed to a potential small loss of volatile extractives from the surface of the specimens already caused by the drying temperature and to the loss of a part of thermally less stable constituent - hemicelluloses. The higher weight losses in this research, resulting from more intensive treatments, could also be potentially attributed to a loss of wood mass, except for the total loss of moisture content, including the volatile extractives and a part of the most vulnerable chemical constituents of wood, such as hemicelluloses or the amorphous parts of cellulose, due to thermal degradation (Kocafee *et al.*, 2008). After 14 days of conditioning in a room at ambient conditions (20±2) °C and (60±5) % relative humidity, the specimens regained moisture from the atmosphere, recording a weight increase, which was higher in the case of milder treatments and lower in the case of more intensive ones, demonstrating a decrease in the hygroscopicity of treated tree-of-heaven wood. Respectively, the specimens recorded a thickness loss tangentially and radially, in measurements conducted directly after the treatments. This thickness loss was lower in the case of milder treatments and higher as the temperature was increased, while after 14 days of conditioning, a small thickness increase was recorded tangentially and radially, with the lowest thickness increase recorded in most intensively treated specimens. Although these findings do not show statistically significant differences, they suggest that thermal treatments affected posi-

tively the dimensional stability and water absorbing capacity of wood.

The *EMC* of thermally treated tree-of-heaven wood was found to be lower than that of the control specimens in each case, and the higher treatment temperature applied, the lower *EMC* value was recorded (Table 2). Specifically, the milder treatment decreased the *EMC* value by 31.76 %, revealing that even the short duration treatment of 2 hours is enough to cause permanent changes in wood mass (hemicelluloses degradation, decrease of hydroxyl groups and hygroscopicity), while the following treatments with higher temperature (210 °C and 230 °C) resulted in 47.84 % and 61.09 % lower *EMC*, respectively, compared to unmodified wood, which is in agreement with the previous results of treated wood, referring to the weight increase during the conditioning process.

Swelling in tangential direction of the specimens subjected to milder treatments (190 °C and 210 °C) presented an increase of 14.91 % and 5.44 % in relation to unmodified wood, referring to the measurement made after 1 day of water immersion, which did not reveal statistically significant differences, while the most intensive treatment recorded the swelling decrease of 54.39 % (Figure 1), which was statistically significant. The measurement carried out after 6 days of water immersion showed similar behaviour of the treated wood. This time, the most intensive treatment presented a swelling decrease of 59.40 %. The radial swelling of treated specimens was found to be lower than the corresponding value of untreated wood in each case, with the improvement of dimensional stability as the treatment temperature was rising. Specifically, a radial

**Table 2** Equilibrium moisture content (*EMC*) of thermally modified and unmodified tree-of-heaven specimens

**Tablica 2.** Ravnotežni sadržaj vode (*EMC*) toplinski modificiranih i nemodificiranih uzoraka pajasena

Treatment / <i>Tretman</i>	<i>EMC</i> , %
Control	9.51 (0.09)*
190 °C	6.49 (0.19)
210 °C	4.96 (0.23)
230 °C	3.70 (0.24)

\* Numbers in parentheses represent the standard deviation of ten replicates. / Brojevi u zagradama standardne su devijacije deset uzoraka.

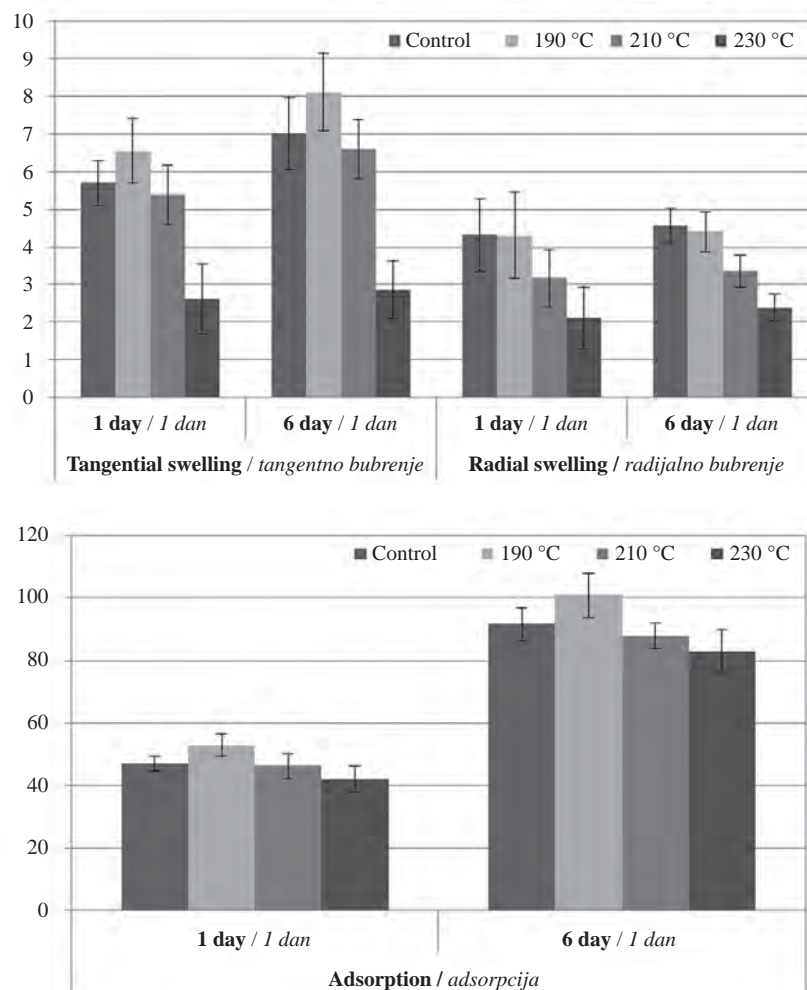

**Figure 1** Swelling (tangential and radial) and adsorption percentage values of tree-of-heaven specimens, measured after 1 and 6 days of immersion in water

**Slika 1.** Bubrenje (tangentno i radijalno) i vrijednosti adsorpcije uzoraka drva pajasena, mjereno nakon jednog i šest dana potapanja u vodi

swelling decrease of 0.23-51.39 % was recorded by thermally treated wood in the measurement made after 1 day of water immersion and similarly 3.72-47.92 % in the measurement after 6 days of immersion, while only the two most intensive treatments marked statistically significant differences from the unmodified wood. Therefore, even though the radial swelling was decreased even from the mildest treatment, this improvement was found to be a little lower than the decrease of the respective tangential swelling. Given that the swelling of wood is usually higher in tangential direction, compared to the radial one, thermal treatment could be considered to improve to a small extent the anisotropy of tree-of-heaven wood.

Referring to adsorption percent values of specimens measured after 1 day of water immersion, the mildest treatment presented an increase of 12.49 % in relation to control specimens, while the treatments of higher temperatures recorded an adsorption decrease of 1.62 % and 10.49 % respectively. After 6 days of immersion in water, the specimens treated in the mildest treatment demonstrated similar behaviour, recording a 10.16 % increase, while increasing the temperature resulted in an adsorption decrease of 4.16 % and 9.54 %, respectively. Despite the fact that these changes

did not correspond to statistically significant differences, they seem to be in agreement with the weight increase and *EMC* changes recorded by the specimens, revealing an enhancement of the dimensional stability of treated tree-of-heaven wood material, potentially attributed to some permanent changes that usually occur during thermal treatments of high temperatures, mainly in the chemical composition of the material and the physical properties (mass loss, density loss, thermal degradation of polysaccharides and lignin, etc.).

Observing the surface colour parameters measured prior to and after the heat treatment of the specimens, it could be noted that *L\** parameter ("Lightness") tends to decrease significantly with the increasing of treatment temperature, and this applies to all the three surfaces of the specimens. In tangential surface, *L\** was found to be 3.22-63.66 % lower, in radial surface 0-62.93 % lower, and in transverse surface 5.89-64.59 % lower, than the respective colour parameter value of untreated specimens (Figure 2). The largest *L\** decrease was detected between the temperatures of 210 °C and 230 °C. That decrease represents the loss of "lightness", resulting in the darkening of wood, and indicates that many components absorbing visible light are formed during heat treatment (Yao *et al.*, 2010). Several other species



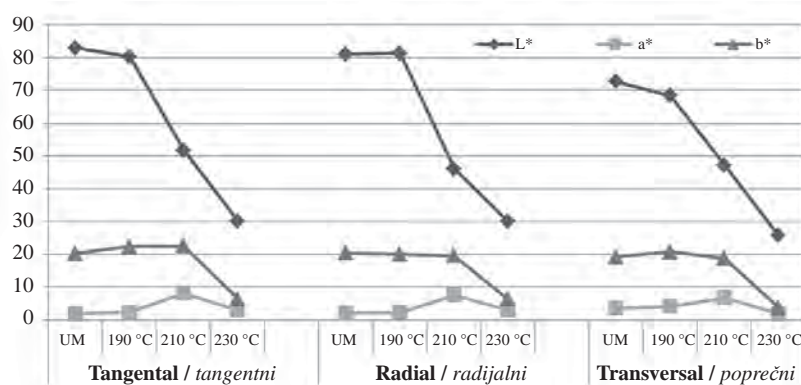

**Figure 2** Change of surface colour parameters  $L^*$ ,  $a^*$  and  $b^*$  of thermally modified and unmodified (UM) tree-of-heaven specimens

**Slika 2.** Parametri promjene boje površine  $L^*$ ,  $a^*$  i  $b^*$  toplinski modificiranih i nemodificiranih (UM) uzoraka pajasena

exposed to heat treatment of similar conditions in literature, as well as in our previous research, also presented such a loss of lightness (Kamperidou *et al.*, 2013, Kamperidou and Barboutsis, 2015 etc.).

Contrarily,  $a^*$  parameter, which positions the colour in a scale of green to red, recorded a slight increase in the mildest treatment, a statistically significant increase at the temperature of 210 °C and a small increase at the highest temperature (230 °C) as well, compared to the level of untreated wood. Parameter  $b^*$ , which depicts the colour coordination in a scale of yellow to blue, demonstrated similar values in wood treated at 190 °C and 210 °C, while it tended to decrease intensively, at levels much lower than those of untreated specimens, as the treatment temperature increased to 230 °C, and this tendency was similar for tangential, radial and transversal surfaces and corresponded to statistically significant differences.

Using the colour parameters  $L^*$ ,  $a^*$  and  $b^*$ , the Total Colour Difference ( $\Delta E^*$ ) and the Saturation Index ( $\Delta C^*$ ) (Table 3) were calculated for each direction of the specimen, representing the overall colour changes of the same sample surfaces prior and after the treatments. The same tendency of parameters  $L^*$ ,  $a^*$  and  $b^*$  was recorded by Yao *et al.* (2010) and by other researches examining properties of other thermally treated species.

Thermal treatment process was proved to strongly modify the surface colour with overall colour differ-

ences ( $\Delta E^*$ ) between untreated and treated specimens to range between 0.48 and 54.57. As expected,  $\Delta E^*$  increased proportionally to the increase of treatment temperature. This decrease of luminance (darkening) of wood surface could be justified by the formation of hemicelluloses and extractives, thermal degradation products or possibly by lignin polymerization reactions during treatment.

The change of red hue ( $\Delta a^*$ ) was positive for almost all treatments, which indicates that the surface colour turned to red. The yellow hue values changed mostly in negative direction ( $\Delta b^*$ ), thus the surfaces became more blue and less yellowish. The treatments caused reduction of lightness, thus the  $\Delta L^*$  values were negative and the colour became darker. Minor changes could be proved by the treatment at the lowest temperature, but the darkening became more significant as the temperature increased. Thus, the colour change is visible to the naked eye, even with the less intensive treatment (Figure 3), which indicates that a thermal treatment of low temperature (190 °C) and short duration (2 hours) is adequate to alter the surface colour of wood. Noticeable is the fact that the higher colour difference values were marked in tangential direction, compared to the radial one, which displayed a little lower total colour difference values, whereas the lowest values of colour difference among the three sides of specimens were recorded in transverse cross-section.

**Table 3** Mean value of Total Colour Difference ( $\Delta E^*$ ) and Saturation Index ( $\Delta C^*$ ) of treated specimens, measured in tangential, radial and transversal surface

**Tablica 3.** Srednja vrijednost ukupne promjene boje ( $\Delta E^*$ ) i zasićenosti ( $\Delta C^*$ ) toplinski modificiranih uzoraka, mjereno na tangentalnome, radialnome i poprečnom presjeku

Treatment <i>Tretman</i>	Surface <i>Površina</i>	$\Delta L^*$	$\Delta a^*$	$\Delta b^*$	$\Delta E^*$	$C^*$	$\Delta C^*$
190 °C	Tangential	-2.67	0.61	2.15	3.48	22.52	2.20
	Radial	0.27	0.04	-0.39	0.48	20.12	-0.38
	Transversal	-4.28	0.60	1.60	4.61	21.28	1.68
210 °C	Tangential	-31.16	6.34	2.28	31.88	23.95	3.63
	Radial	-34.89	5.42	-0.82	35.32	21.00	0.49
	Transversal	-25.46	3.27	-0.49	25.67	19.98	0.38
230 °C	Tangential	-52.79	1.32	-13.77	54.57	7.19	-13.13
	Radial	-51.04	0.94	-14.06	52.95	7.06	-13.44
	Transversal	-46.94	-1.73	-15.55	49.48	4.14	-15.45



**Figure 3** Specimens after the completion of compression strength test  
**Slika 3.** Uzorci nakon ispitivanja čvrstoće na tlak

The darkening of thermally treated wood could provide additional aesthetic value to the material and expand the range of applications due to its resemblance to tropical species of high mechanical properties and durability.

According to the findings (Table 4), thermal treatment appeared to influence some mechanical properties of tree-of-heaven wood in a positive way and some of them in a negative way. More specifically, as the intensity of the thermal treatment increased, the values of modulus of rupture (*MOR*) and the impact bending strength appeared to decrease, while *MOE* and compression strength increased to a small extent.

Mean *MOR* values of specimens treated at 190 °C and 210 °C were found to be at similar level to those of untreated wood, while the specimens treated at 230 °C presented a *MOR* decrease of 31.22 %. Consequently, only the most intensive treatment influenced negatively the bending strength of tree-of-heaven wood, marking a statistically significant difference. Similarly, the impact bending strength of specimens treated at 190 °C and 210 °C was not affected by the treatments, while the treatment at higher temperature (230 °C) revealed a statistically significant decrease of impact strength of 67.31 %. On the contrary, *MOE* of thermally treated specimens was found to be improved by 1.72 %, 5.57 % and 33.42 %, referring to specimens treated at 190 °C, 210 °C and 230 °C, respectively, compared to untreated wood; only the specimens treated at 230 °C showed significant difference from *MOE* of untreated wood. The mildest treatment of 190 °C slightly increased (by 4.87 %) the strength of tree-of-heaven specimens to compressive forces, while the treatments

at 210 °C and 230 °C recorded 17.16 % and 2.01 % higher compression strength, respectively, compared to untreated wood. Only the treatment at 210 °C revealed a statistically significant increase of compression strength, while the most intensive treatment appeared to drop again the compression strength to the level of untreated wood. Esteves *et al.* (2007) confirmed that *MOE* and compressive strength are less affected by heat, since the impact of the decomposition of hemicelluloses is lower than that of cellulose and lignin.

#### 4 CONCLUSIONS 4. ZAKLJUČAK

In the framework of climate change, tree-of-heaven could acquire increasing importance through its utilization in the production of wood based products and structures, given its satisfying properties combined with its fast growth. Thermally treated tree-of-heaven wood, presented a weight loss compared to unmodified wood, caused by the thermo-degradation process, reduced *EMC*, swelling and adsorption, enhanced dimensional stability, compared to untreated wood and this tendency was even more intense as the treatment temperature increased, while the anisotropy of wood was slightly reduced. The short treatment of 2 hours was quite enough to turn the surface colour of wood to darker, more desirable tones. Only the most intensive treatment deteriorated *MOR* and impact strength significantly, whereas *MOE* and compression strength presented an increase, compared to control wood. Tree-of-heaven could benefit from a short and mild or of medium intensity heat treatment, in order to be mod-

**Table 4** Mechanical properties of thermally modified and unmodified tree-of-heaven wood  
**Tablica 4.** Mehanička svojstva toplinski modificiranoga i nemodificiranog drva pajasena

Property / Svojstvo	Control / Kontrola	190 °C	210 °C	230 °C
<i>MOR</i>	114.14 (6.01)*	116.84 (5.50)	111.71 (4.98)	78.50 (11.15)
<i>MOE</i>	9351.1 (364.3)	9511.9 (372.0)	9872.0 (431.4)	12475.8 (940.3)
Impact Bending / udar	4.65 (0.52)	4.60 (0.77)	3.92 (0.70)	1.52 (0.50)
Compression / tlak	57.69 (3.11)	60.50 (2.74)	67.59 (3.35)	58.85 (5.26)

\* Numbers in parentheses represent standard deviation of ten replicates. / Brojevi u zagradama standardne su devijacije deset uzoraka.

ified to an aesthetically attractive wood with enhanced hygroscopicity, facilitating its use in cabinetry and variable indoor and outdoor non-structural applications.

## 5 REFERENCES

### 5. LITERATURA

1. Ates, S.; Akyildiz, M. H.; Özdemir, H.; Gumuskaya, E., 2010: Technological and chemical properties of chestnut (*Castanea sativa* Mill.) wood after heat treatment. *Romanian Biotechnological Letters*, 15 (1): 4949-4958.
2. Bächle, H.; Zimmer, B.; Windeisen, E.; Wegener, G., 2010: Evaluation of thermally modified beech and spruce wood and their properties by FT-NIR spectroscopy. *Wood Science and Technology*, 44 (3): 421-433. <https://doi.org/10.1007/s00226-010-0361-3>.
3. Barboutis, I.; Vasileiou, V., 2009: Physical and Mechanical Properties of *Ailanthus altissima* (Miller) Swingle wood. In: *Proceedings of the 14<sup>th</sup> Panhellenic Forest Conference*, 1-4 November 2009, Patra, Greece, p.p. 137-144.
4. Brandner, R.; Schickhofer, G., 2010: Tree-of-Heaven (*Ailanthus altissima*): Enormous and wide potential neglected by the Western civilisation. In: *Proceedings of the World Conference on Timber Engineering*. Riva del Garda, Italy, 20-24 June 2010, p.p.1-7.
5. Demirbas, A., 2001: Energy balance, energy sources, energy policy, future developments and energy investments in Turkey. *Energy Conversion and Management*, 42 (10): 1239-1258. [https://doi.org/10.1016/S0196-8904\(00\)00109-6](https://doi.org/10.1016/S0196-8904(00)00109-6).
6. Esteves, B.; Velez Marques, A.; Domingos, I.; Pereira, H., 2007: Influence of steam heating on the properties of pine (*Pinus pinaster*) and eucalypt (*Eucalyptus globulus*) Wood. *Wood Science and Technology*, 41: 193-207. <https://doi.org/10.1007/s00226-006-0099-0>.
7. Hakkou, M.; Petrissans, M.; Gerardin, P.; Zoulalian, A., 2006: Investigations of the reasons for fungal durability of heat-treated beech wood. *Polymer Degradation and Stability*, 91 (2): 393-397. <https://doi.org/10.1016/j.polymdegradstab.2005.04.042>.
8. Hu, S. Y., 1970: Dendrobium in Chinese medicine. *Economic Botany*, 24: 165-174. <https://doi.org/10.1007/BF02860596>.
9. Kamperidou, V.; Barboutis, P., 2015: Correlation between the changes of Colour and Mechanical properties of Thermally-modified Scots Pine (*Pinus sylvestris* L.) Wood. *PRO Ligno*, 11 (4): 360-365.
10. Kamperidou, V.; Barboutis, I.; Vasileiou, V., 2013: Response of Colour and Hygroscopic properties of Scots Pine wood to thermal modification. *Journal of Forestry Research*, 24 (3): 571-575.
11. Kumar, D.; Bhat, Z. A.; Singh, P.; Shah, M. Y.; Bhujbal, S. S., 2010: *Ailanthus excelsa* Roxb. is Really a Plant of Heaven. *International Journal of Pharmacology*, 6 (5): 535-550. <https://doi.org/10.3923/ijp.2010.535.550>.
12. Kocaeffe, D.; Poncsak, S.; Boluk, Y., 2008: Effect of thermal treatment on the chemical composition and mechanical properties of Birch and Aspen. *BioResources*, 3 (2): 517-537.
13. Kozuharova, E.; Lebanova, H.; Getov, I.; Benbassat, N.; Kochmarov, V., 2014: *Ailanthus altissima* (Mill.) Swingle – a terrible invasive pest in Bulgaria or potential useful medicinal plant? *Bothalia Journal*, 44 (3): 213-230.
14. Kudela, J.; Mamonova, M., 2006: Tree-of-heaven wood (*Ailanthus altissima*, Mill.) – structure and properties. *Wood Structure and Properties '06*, Arbora Publishers, Zvolen, Slovakia, pp. 275-280.
15. Moslemi, A. A.; Bhagwat, S. G., 1970: Physical and mechanical properties of the wood of tree-of-heaven. *Wood and Fiber Science*, 1 (4): 319-323.
16. Olek, W.; Bonarski, J. T., 2008: Texture changes in thermally modified wood. *Archives of Metallurgy and Materials*, 53 (1): 207-211. <http://journals.pan.pl/dlibra/journal/97808>.
17. Panayotov, P.; Kalmukov, K.; Panayotov, M., 2011: Biological and wood properties of *Ailanthus altissima* (Mill.) Swingle. *Forestry Ideas*, 17 (2): 122-130.
18. Tuong, V. M.; Li, J., 2010: Effects of heat treatment on the change in color and dimensional stability of Acacia Hybrid wood. *BioResources* 5 (2): 1257-1267. <https://doi.org/10.15376/biores.5.2.1257-1267>.
19. Wikberg, H.; Maunu, S., 2004: Characterisation of thermally modified hard- and softwoods by <sup>13</sup>C CPMAS NMR. *Carbohydrate Polymers*, 58 (4): 461-466. <https://doi.org/10.1016/j.carbpol.2004.08.008>.
20. Yao, C.; Yongming, F.; Jianmin, G.; Houkun, L., 2010: Coloring characteristics of in situ lignin during heat treatment. *Wood Science and Technology*, 46 (1-3): 33-40. <https://doi.org/10.1007/s00226-010-0388-5>.

### Corresponding address:

Dr. KAMPERIDOU VASILIKI

Aristotle University of Thessaloniki  
Faculty of Forestry and Natural Environment  
Department of Harvesting and Forest Products  
Technology  
Thessaloniki, GREECE  
e-mail: vkamperi@for.auth.gr

# Eco-Friendly Laminated Strand Lumber from Date Palm Rachis: Analysis of Mechanical Properties by Taguchi Design of Experiment

Ekološki prihvatljiva uslojena drvonitna građa od lisnih osi palme datulje: analiza mehaničkih svojstava *Taguchi* metodom pripreme istraživanja

## Original scientific paper • Izvorni znanstveni rad

Received – prispjelo: 20. 9. 2018.

Accepted – prihvaćeno: 20. 11. 2019.

UDK: 630\*812.71; 630\*812.72; 630\*863

<https://doi.org/10.5552/drvind.2019.1843>

**ABSTRACT** • This study was performed to use date palm rachis, as a low value bio-waste, in the manufacture of a high value added eco-friendly structural composite lumber. Taguchi design of experiments was applied to analyze the effect of raw material and product parameters on the mechanical properties of laminated strand lumber from date palm rachis. The results indicate that the composite exhibits similar or superior strength properties compared to solid lumber and engineered products from wood or other lignocellulosic material for building sector. Taguchi design of experiments was assessed as a powerful and cost effective technique to obtain optimal levels for maximizing the mechanical properties of the environmentally-friendly composite. Maximum values for the mechanical properties of date palm rachis-based LSL were obtained from a combination of 20 mm product thickness, 10 % resin content, 4mm strand thickness, and 850 kg/m<sup>3</sup> product density. Product thickness with an 81.3 % contribution and strand thickness with an 80 % contribution have the highest effects on the flatwise stiffness and compression strength perpendicular to grain, respectively.

**Keywords:** date palm rachis, structural composite lumber, laminated strand lumber, Taguchi design of experiments, mechanical properties

**SAŽETAK** • Ovo je istraživanje provedeno na konstrukcijskoj kompozitnoj građi proizvedenoj od lisnih osi palme datulje. Te su lisne osi odabrane kao biootpad male vrijednosti da bi se dobila građa visoke dodane vrijednosti. Taguchi metoda pripreme istraživanja primijenjena je kako bi se analizirao utjecaj sirovine i svojstava proizvoda na mehanička svojstva uslojene drvonitne građe (LSL) od lisnih osi palme datulje. Rezultati pokazuju da kompoziti

<sup>1</sup> Authors are MSc. student and assistant professor at University of Tehran, Faculty of Natural Resources, Department of Wood and Paper Science and Technology, Karaj, Iran.

<sup>1</sup> Autori su student i docent Sveučilišta u Teheranu, Prirodoslovno-matematički fakultet, Zavod za znanost i tehnologije drva i papira, Karaj, Iran.

imaju sličnu ili bolju čvrstoću nego masivno drvo i građevinski proizvodi od drva ili od ostalih lignoceluloznih materijala. Taguchi metoda pripreme istraživanja ocijenjena je kao pouzdana i isplativa tehnika za dobivanje optimalnih mehaničkih svojstava ekološki prihvatljivih kompozita. Najveće vrijednosti mehaničkih svojstava LSL-a od lisnih osi palme datulje dobivene su za proizvod debljine 20 mm, sa sadržajem smole od 10 %, debljine vlakana 4 mm i gustoće 850 kg/m<sup>3</sup>. Najveći utjecaj na krstost plohe i čvrstoću na tlak imaju debljina proizvoda, s 81,3 %, i debljina vlakana, s 80 % utjecaja.

**Cljučne riječi:** lisne osi palme datulje, konstrukcijska kompozitna građa, uslojena drvonitna građa, Taguchi metoda pripreme istraživanja, mehanička svojstva

## 1 INTRODUCTION

### 1. UVOD

Laminated strand lumber (LSL) is a structural composite lumber (SCL) consisting of wood strands that are glued, oriented and compressed to form one of the engineered wood products (EWPs). Almost all strands in LSL are typically oriented in one direction (Moses *et al.*, 2003). By changing strand orientation, axial and flexural stiffness, and strength properties can be modified for specific applications (Moses *et al.*, 2003). This material is used primarily as an alternative to traditional solid sawn lumber and other engineered wood products like laminated veneer lumber and glued laminated timber. Similar to other structural composite lumber, LSL as a relatively new wood-based product is an ideal structural solution for broad range of construction applications including rim board, millwork and window, door and garage door headers, as well as for many industrial uses. New uses for this product are still evolving including the use of LSL for vertical elements of structural frames, where the framing member heights are long and the wind loads are substantial (Wang *et al.*, 2015). The quality of raw material extremely affects the properties of LSL. It can be made from less expensive and readily available underutilized timber. Nowadays, traditional strong, dense species like oak, southern pine and Douglas fir are being replaced by low quality, low diameter and less dense species like spruce, European white woods, and aspen. Although these species do not have the strength and stiffness of the above timber, they are light in color, lightweight and stable. In addition, this is an excellent way to maximize the wood fiber resources that are readily available, allowing for a cost-effective product. Faced with the risk of forest extinction and wood shortages, especially in dry and semi-dry regions such as I. R. Iran, and environmental considerations, the use of natural hardwoods, such as beech, alder, hornbeam, has been decreased. On the other hand, agricultural and horticultural residues have an excellent potential for the production of structural and non-structural wood-based composites. These materials are abundant and can be obtained at a very low cost. Date palm (*Phoenix dactylifera* L.) has long been one of the most important fruit crops in the arid regions of the Arabian Peninsula, North Africa, and the Middle East. During the past three centuries, dates were also introduced to new production areas in Australia, India/Pakistan, Mexico, Southern Africa, South America, and the United States. Dates are a main income source and staple food for local populations in many countries, in which they are

cultivated, and they have played significant roles in the economy, society, and environment of those countries (Chao and Krueger, 2007). Almost every part of the date palm can be used for different purposes including fiber from the trunk and leaves, dried bundles of leaves, ribs of the leaves, and the base of the leaves and fruit stalks (Nixon, 1951; Dowson and Aten, 1962; Barreveld, 1993; Chao and Krueger, 2007). The date palm residues are usually used to produce traditional and low value products or high value added non-structural products such as hardboard (EI-Morsy 1980) and paper (Khaiari *et al.*, 2010). Some of the few studies around the SCLs from solid wood are as follow: Hoover *et al.* (1992) studied the effect of strand orientation on the properties of strand panels. A novel concept of using strands from small-diameter timber to produce engineered composite Laminated Strand Ply (LSP) was presented and demonstrated by Weight (2007). Wang *et al.* (2015) and Ozcifci *et al.* (2010) determined the mechanical properties of laminated strand lumber (LSL), parallel strand lumber (PSL) and laminated veneer lumber (LVL) from aspen poplar, and Wang *et al.* (2016) evaluated the modulus of elasticity of LSL by non-destructive testing. Based on the literature review, there is a lack of information around SCL from horticultural residues. Therefore, the objective of the current study was to develop a type of laminated strand lumber from date palm rachises as an eco-friendly replacement for solid wood lumbers and engineered wood products. Taguchi design of experiments was used to analyze the effects of raw material parameters on the mechanical properties of the product.

## 2 MATERIALS AND METHODS

### 2. MATERIJALI I METODE

#### 2.1 Raw material preparation

##### 2.1. Priprema sirovine

The date palm leaves (Figure 1) were collected from date palm plantation around Khalili village, Lamerd County, Fars province, I. R. Iran. The leaves were cleaned of midribs, spines and impurities, and then rachises were trimmed into suitable size in the Laboratory of Wood-Based Products, Department of Wood and Paper Sciences and Technology, Natural Resources Faculty, University of Tehran. The average moisture content and density of the rachises were measured as 9 % and 330 kg/m<sup>3</sup>, respectively. Polymeric methylene diphenyl diisocyanate (PMDI) adhesive (Molecular formula C<sub>15</sub>H<sub>10</sub>N<sub>2</sub>O<sub>2</sub>, Molar Mass 250.25 g/mol, Density 1.230 g/cm<sup>3</sup>, Melting point 40 °C, Boiling point 314 °C and Flash Point 212–214 °C)

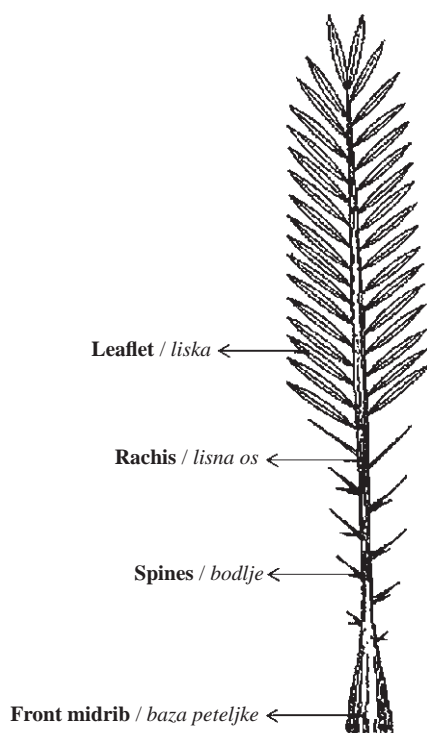

**Figure 1** Different parts of a date palm leaf (Zaid and De Wet, 2002)

**Slika 1.** Dijelovi lista palme datulje (Zaid and De Wet, 2002.)

was prepared from one of the importing company, Tehran, I. R. Iran.

After cleaning, the rachises were simply trimmed into suitable long strands (450 mm length, 10-30 mm width, and 2 mm and 4 mm nominal thickness) parallel to grain (Figures 2a, b). After preparation, the strands were dried to around 3 % dry based moisture content using a laboratory tray dryer at 103 °C and were kept in sealed plastic bags until billet making.

**Table 1** Taguchi design of experiments (L8 4\*\*1 2\*\*4)

**Tablica 1.** Taguchi metoda planiranja pokusa (L8 4\*\*1 2\*\*4)

Run No. Broj niza	Product thickness, mm Debljina proizvoda, mm	Resin content, % Sadržaj smole, %	Strand thickness, mm Debljina iverja, mm	Product target density, kg/m <sup>3</sup> Ciljana gustoća proizvoda, kg/m <sup>3</sup>
1	12	8	4	850
2	12	10	2	750
3	16	8	2	750
4	16	10	4	850
5	18	8	2	850
6	18	10	4	750
7	20	8	4	750
8	20	10	2	850

**Table 2** Constant parameters for block preparation

**Tablica 2.** Konstantni parametri za pripremu blokova

Parameter / Parametar	Type and value / Vrsta i vrijednost
Resin / smola	Polymeric methylene diphenyl diisocyanate (PMDI)
Billet / blok	Homogenous laminated strand lumber homogena uslojena drvonitna građa
Additive / dodatak	-
Dimension / dimenzija, mm	450 × 450
Pressing pressure / tlak prešanja, kg/cm <sup>2</sup>	40
Pressing temperature / temperatura prešanja, °C	170
Pressing time / vrijeme prešanja, s	540



**Figure 2** Strands from date palm rachises: a) single, b) bundle

**Slika 2.** Vlakna od lisnih osi palme datulje: a) samostalna vlakna, b) snop vlakana

## 2.2 Design of experiments

### 2.2. Planiranje pokusa

Based on the number of variables (such as product thickness, resin content, strand thickness and product density) and their levels, a suitable Taguchi orthogonal array (L8 4\*\*1 2\*\*3 design sheet) was chosen for design of experiments (Table 1). Taguchi method is a helpful technique for reducing the number of experiments, which requires understanding the effects of process parameters on product response, besides separating the significant factors affecting the response from less significant factors (Reddy *et al.*, 2012). MINITAB 16 statistical software (State College, PA, USA) was used to analyze the experiments.

To follow the design of experiments, a total of 8 laboratory LSL blocks for the eight different combinations were prepared (Table 1).

## 2.3 Billet preparation

### 2.3. Priprema blokova

The block characteristics and constant parameters for making date palm rachis-based laminated strand lumber (LSL) are presented in Table 1 and 2.

For making the blocks, sufficient amounts of PMDI resin were sprayed onto the prepared strands us-

ing a laboratory rotary drum blender consisting of an internal spray nozzle. Then, the glued strands were manually formed into mats (all strands oriented in one direction) using a man-made frame. All the mats were pressed by a hydraulic hot press, BÜRKLE, Germany, under constant pressing parameters (Table 2).

**2.4 Block characterization**

2.4. Karakterizacija blokova

For characterization, all the blocks were kept in a conditioning chamber at 20 °C and 65 % RH for two weeks, according to ASTM D1037 (2003). After conditioning, the blocks were cut into standard test specimens (Figure 3) and returned into the chamber to retain standard equilibrium moisture content until physical and mechanical experiments.

Characteristics of moisture content and density were measured based on ASTM D1037 (2003). Three-point static bending strength ( $F_b$ ) and stiffness ( $E$ ) were measured in accordance with ASTM D 5456 (2003). Compression strength ( $F_c$ ) parallel and perpendicular to grain were measured according to ASTM D 198 (2003) and ASTM D 143 (2003), respectively. Shear strength ( $F_v$ ) parallel to grain was measured in accordance with ASTM D 143 (2003).

**2.5 Analysis of variance**

2.5. Analiza varijance

Taguchi design of experiments was used for the analysis of variance. This method uses signal to noise ratio (S/N ratio) instead of the average value to interpret the trial results data into a value for the evaluation characteristic in the optimum setting analysis (Phadke 1989; Ross 1996). In Taguchi design of experiments, quality characteristics are classified into three categories: the smaller the better, the nominal the better and the bigger the better. Since, for the mechanical strength, higher values are expected, the bigger the better S/N ratio was applied in the analysis, which can be calculated using Eq. 1:

$$S / N = -10 \log_{10} \left[ (1/n) \cdot \sum (1/y_i^2) \right] \quad (1)$$

Where  $y$  is the measured data and  $n$  is the number of trial (Mizamzul Mehat *et al.*, 2011). The analysis of variance (ANOVA) establishes the relative significance of factors in terms of their percentage contribu-



**Figure 3** Examples of test specimens from date palm rachis-based LSL blocks

**Slika 3.** Primjeri ispitnih uzoraka LSL blokova od lisnih osi palme datulje

tion to the response (Phadke, 1989; Ross, 1996). ANOVA analysis is also needed for estimating the variance of error for the effects and confidence interval of the prediction error. This analysis is performed on S/N ratio to obtain the percentage contribution of each factor (Gaitonde *et al.*, 2007).

**3 RESULTS AND DISCUSSION**

3. REZULTATI I RASPRAVA

Predicted versus experimental results for mechanical properties is shown in Table 3. Note that adjusted values were used to remove the variation in the properties caused by sample density tolerance (Xing *et al.*, 2007). Average relative error between the measured and predicted values for the mechanical properties was 2.33 %. From the results, it can be concluded that Taguchi method can satisfactorily predict the mechanical properties of rachis-based LSL (Table 3).

The comparison of specific mechanical properties of LSL from date palm rachis, lumber from solid wood and some structural composite lumber is shown in Table 4.

For rachis-based LSL, average specific bending strength (164.75 MPa) is approximately the same as the average value for clear wood (168.74 MPa) and is higher than that of structural composite lumber (around

**Table 3** Comparison of measured and predicted values for mechanical properties of rachis-based LSL

**Tablica 3.** Usporedba izmjerenih i predviđenih vrijednosti mehaničkih svojstava LSL-a na osnovi lisnih osi palme datulje

Run No. Broj niza	$F_b$ (MPa)				$E$ (GPa)				$F_c$ (MPa)				$F_v$ (MPa)	
	Flat / Ploha		Edge / Rub		Flat / Ploha		Edge / Rub				⊥		Meas.	Pred.
	Meas.	Pred.	Meas.	Pred.	Meas.	Pred.	Meas.	Pred.	Meas.	Pred.	Meas.	Pred.		
1	117	142	51	59	32.1	25.7	7.63	6.7	28	27	1.5	1.49	3.7	4.25
2	137	112	52	43	24.6	19.6	7.44	8.4	20	21	0.64	0.70	3.82	3.26
3	111	136	58	67	20	16	7	6	27	26	0.53	0.46	3.79	4.34
4	171	146	105	96	25.7	21.8	9.3	10.2	45	46	1.2	1.24	6.1	5.54
5	94	68	61	53	14.1	12.9	5.8	6.73	35	37	0.86	0.92	4.96	4.40
6	113	138	76	82	15.1	15.4	7.5	6.6	49	48	2	1.94	4.84	5.4
7	221	196	104	95	19.8	16.9	9.2	10.1	36	37	1.55	1.61	6.23	5.67
8	80	105	71	80	16.8	14	17.1	16.2	41	40	0.64	0.58	4.37	4.92

$F_b$  – bending strength / čvrstoća na savijanje;  $E$  – modulus of elasticity / modul elastičnosti;  $F_c$  – compression strength / čvrstoća na tlak;  $F_v$  – shear strength / smična čvrstoća

**Table 4** Bending strength, bending stiffness and compression strength for different wood-based structural materials

**Tablica 4.** Čvrstoća na savijanje, krutost na savijanje i čvrstoća na tlak za različite konstrukcijske materijale na bazi drva

Material / Materijal	Reference Referenca	Mechanical properties (specific value*) Mehanička svojstva (specifične vrijednosti*)		
		$F_b$ , MPa	$E$ , GPa	$F_c$ l, MPa
<b>Clear wood / drvo</b>				
White oak / bijeli hrast	(Cai and Ross, 2010)	154.12	18.05	-
Red maple / crveni javor	(Cai and Ross, 2010)	171.09	20.95	-
Douglas-fir (Coastal) / američka duglazija (Coastal)	(Cai and Ross, 2010)	178.1	28	-
Western white pine / zapadnoamerički bijeli bor	(Cai and Ross, 2010)	176	26.5	-
Longleaf pine / dugoičičavi bor	(Cai and Ross, 2010)	169.5	23.14	-
Spruce ( <i>Picea abies</i> ) / smreka ( <i>Picea abies</i> )	(Malanit <i>et al.</i> , 2011)	163.64	19.32	-
<b>Structural composite lumber Konstrukcijska kompozitna građa</b>				
Glulam / lijepljeno lamelirano drvo	(Cai and Ross, 2010)	71.52-104.37	22.5-24.17	-
LVL	(Cai and Ross, 2010)	84.45-123.11	27.4-27.49	-
LVL	(Ozcifci <i>et al.</i> , 2010)	161.27	19.768	124.67
PSL	(Ozcifci <i>et al.</i> , 2010)	136.87	17.874	99.66
LSL	(Ozcifci <i>et al.</i> , 2010)	123.66	16.045	83.82
Bamboo-based OSL**	(Malanit <i>et al.</i> , 2011)	82.24	13.81	-
<b>Date palm rachis-based LSL (number of treatment) / LSL na bazi lisnih osi palme datulje (broj tretmana)</b>				
1		135.83	37.794	29.80
2		182.59	32.794	30.86
3		147.46	26.645	32.46
4		201.08	30.199	56.65
5		110.08	16.588	44.49
6		150.96	20.157	61.80
7		295.90	26.094	51.55
8		94.09	19.824	44.71

\*Properties divided by specific gravity; \*\*oriented strand lumber / \*Svojstva podijeljena prema specifičnoj težini; \*\*građa s usmjerenim iverjem;  $F_b$  – bending strength / čvrstoća na savijanje;  $E$  – modulus of elasticity / modul elastičnosti;  $F_c$  – compression strength / čvrstoća na tlak

1.42 times). Furthermore, average specific stiffness for rachis-based LSL is approximately 17 % and 33 % higher than that of clear wood and structural composite lumber, respectively. Comparing the maximum values for the materials, specific bending strength for treatment No. 7 is approximately 66 % and 140 % higher than that of Douglas-fir and medium density laminated veneer lumber, respectively. In addition, specific stiffness for treatment No.1 is approximately 35 % and 37 % higher than that of Douglas-fir and medium density laminated veneer lumber, respectively (Table 4). From the specific bending strength and stiffness values presented in Table 4, it can be deduced that the rachis-based LSL is an appropriate alternative to clear wood and structural composite lumber for structural purposes (Cai and Ross, 2010; Ozcifci *et al.*, 2010; Malanit *et al.*, 2011).

The highest specific compression strength parallel to grain value was obtained in treatment No. 6 as 61.80 N/mm<sup>2</sup>, which is lower than that of LVL, PSL, and LSL from poplar wood, being 102 %, 61 %, and 36 %, respectively. It may be due to lower maximum crushing strength of date palm rachis strand than that of solid wood strand, and penetration of resin into more porous structure of date palm rachis than that of solid wood. On the other hand, the structure of samples and

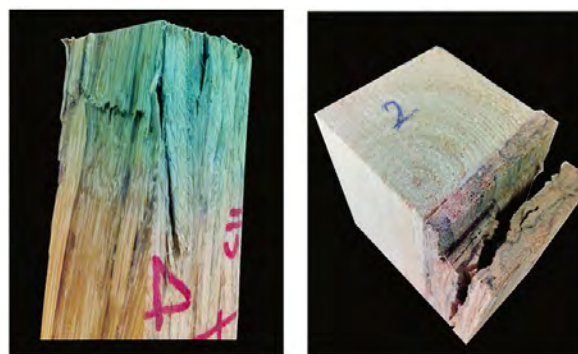

**Figure 4** Fracture modes for test specimens: Compression strength parallel to grain (left), shear strength parallel to grain (right)

**Slika 4.** Načini loma ispitivanih uzoraka: čvrstoća na tlak paralelno s vlakancima (lijevo), smična čvrstoća paralelno s vlakancima (desno)

test conditions were different. Fracture modes of test specimens in compression and shear strengths parallel to grain are shown in Figure 4.

S/N ratio values for parameters and delta values are shown in Table 6 and 5, respectively. The highest S/N ratio indicated the optimal combination of the parameters. S/N ratio also showed the importance of the order of parameters.



**Table 5** Results of delta value for all mechanical properties  
**Tablica 5.** Rezultati delta-vrijednosti za sva mehanička svojstva

Parameter Parametar	$F_b$		$E$		$F_c$		$F_v \parallel$
	Flat / Ploha	Edge / Rub	Flat / Ploha	Edge / Rub		⊥	
Product thickness / debljina proizvoda	2.5	4.4	5.7	5.5	4.8	4.4	2.8
Resin content / sadržaj smole	0.5	0.8	0.2	2.5	1.3	0.2	0.3
Strand thickness / debljina iverja	3.2	2.4	1.6	2.2	2.2	7.4	1.7
Product density / gustoća proizvoda	2.0	0.02	0.6	1.4	1.4	0.08	0.2

$F_b$  – bending strength / čvrstoća na savijanje;  $E$  – modulus of elasticity / modul elastičnosti;  $F_c$  – compression strength / čvrstoća na tlak;  $F_v$  – shear strength / smična čvrstoća

Ranking of the parameters was determined by comparison of delta values (Table 5). The delta value is equal to the difference between maximum and minimum values for each parameter level (Hamzacebi, 2016). Table 5 shows that the order of importance in maximizing the mechanical properties of the specimens is as follow: For flatwise bending strength, strand thickness, followed by product thickness, product density and resin content. For edgewise bending strength and shear strength parallel to grain, product thickness, followed by strand thickness, product density and resin content. For flatwise stiffness and compression strength parallel to grain, product thickness, followed by strand thickness, product density and resin content. For edgewise MOE, product thickness, followed by resin content, strand thickness and product density, and for compression strength perpendicular to grain, strand thickness, followed by product thickness, resin content and product density.

Based on “the bigger the better” issue, Table 6 shows the optimal parameter levels for mechanical properties of rachis-based LSL. As concluded from the table, the forth level of product thickness (20 mm), and the second levels of resin content (10 %), strand thickness (4 mm) and product density (850 kg/m<sup>3</sup>) were the optimal values for maximizing shear and compression strength parallel to grain and edgewise bending strength. The optimal values for other mechanical properties were as follow: for flatwise bending strength, the second levels of product thickness (16 mm) and strand thickness (4 mm), and the first levels of resin

content (8 %) and product density (750 kg/m<sup>3</sup>). For flatwise stiffness, the first levels of product thickness (12 mm) and resin content (8 %), and the second levels of strand thickness (4 mm) and product density (850 kg/m<sup>3</sup>). For compression strength parallel to grain, the third level of product thickness (18 mm) and the second levels of resin content (10 %), strand thickness (4 mm) and product density (850 kg/m<sup>3</sup>), and for compression strength perpendicular to grain, the third level of product thickness (18 mm), second level of strand thickness (4 mm) and the first levels of resin content (8 %) and product density (750 kg/m<sup>3</sup>) (Table 6 and Figure 5).

Table 6 shows that the forth level of product thickness (20 mm), and the second levels of resin content (10 %), strand thickness (4 mm) and product density (850 kg/m<sup>3</sup>) were the optimal values for maximizing the mechanical properties of date palm rachis-based LSL. Based on the F-value, it should be noted that, while the parameters significantly affect flatwise stiffness at 5 % confidence interval, the effects of product thickness, resin content, strand thickness and product density are not significant on the other mechanical properties (Table 7). The strands used in this study had a constant length of 450 mm and thicknesses of 2 mm and 4 mm with slenderness ratios of 225 and 112.5, respectively. A model by Simpson (1977) indicated that increasing the slenderness ratio resulted in an initial increase of tensile strength, which then began to level off at higher ratios. Barnes (2001) concluded that, by increasing the L/t ratio, the stress transfer angle be-

**Table 6** Optimal parameter levels for mechanical properties  
**Tablica 6.** Optimalne razine parametara mehaničkih svojstava

Parameter Parametar	Level Razina	Signal to noise ratio / Omjer signala i šuma						$F_v \parallel$
		$F_b$		$E$		$F_c$		
		Flat Ploha	Edge Rub	Flat Ploha	Edge Rub		⊥	
Product thickness, mm debljina proizvoda, mm	12	42	34.2	88.9	77.5	27.5	-0.03	11.5
	16	42.7	37.8	87.1	78.1	30.9	-2	13.6
	18	40.2	36.5	83.2	76.3	32.3	2.3	13.8
	20	42.4	38.6	85.1	81.9	31.6	-0.03	14.3
Resin content, % sadržaj smole, %	8	42.1	36.3	86.2	77.2	29.9	0.18	13.1
	10	41.6	37.2	86	79.7	31.2	-0.07	13.4
Strand thickness, mm debljina iverja, mm	2	40.2	35.6	85.3	78.5	29.4	-3.6	12.4
	4	43.4	38	86.9	78.4	31.7	3.7	14.1
Product density, kg/m <sup>3</sup> gustoća proizvoda, kg/m <sup>3</sup>	750	42.9	36.80	85.8	77.7	29.8	0.09	13.2
	850	40.8	36.82	86.4	79.2	31.3	0.01	13.4

$F_b$  – bending strength / čvrstoća na savijanje;  $E$  – modulus of elasticity / modul elastičnosti;  $F_c$  – compression strength / čvrstoća na tlak;  $F_v$  – shear strength / smična čvrstoća

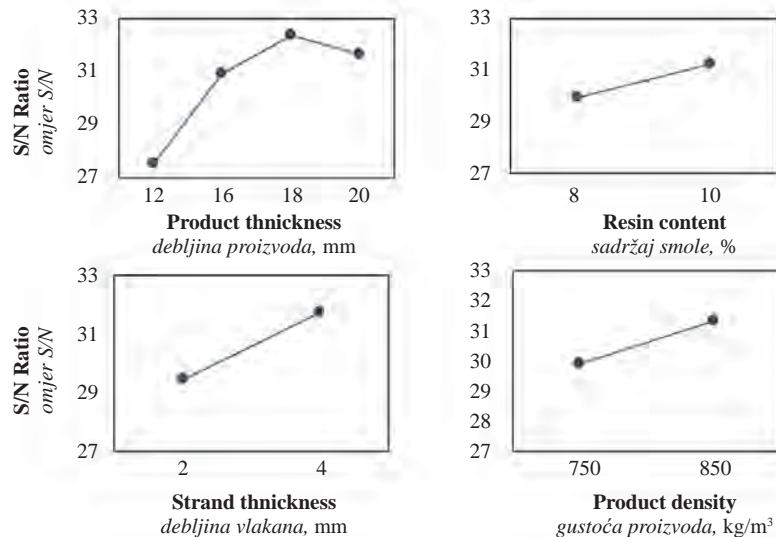

**Figure 5** Main effect plot of S/N ratio for compression strength parallel to grain  
**Slika 5.** Prikaz učinka omjera S/N na čvrstoću na tlak u smjeru vlakana

tween strands decreased, tending to a more efficient stress transfer between strands. A study by Stoffko (1960) for the ratios ranging from 35-300 showed a similar trend with strength values. On the other hand, another effect of raising the slenderness ratio is that the total surface area of strands is increased. As surface area increases, the amount of resin required to transfer stresses to adjacent strands also increases. Consequently, according to this study, the relationship between the surface area and mechanical properties would be more significant than the effect of stress transfer angle on the mechanical properties, especially since a good bond is required for stress transfer.

The results of ANOVA analysis and the percentage contribution of each parameter on the mechanical properties of rachis-based LSL are shown in Table 7 and 8. Product thickness most highly affected edgewise bending strength, flatwise and edgewise MOE, and compression and shear strengths parallel to grain. In addition, strand thickness had the highest effect on flatwise bending strength and compression strength perpendicular to grain. For flatwise bending strength, the contribution of strand thickness was 34.33 %. The

second parameter was product thickness, with a 17.11 % contribution, followed by product density, and resin content, with a contribution of 12.4 % and 1.44 %, respectively. For edgewise bending strength, the contribution of product thickness was 47.4 %. The second parameter was strand thickness (33.38 % contribution), followed by resin content (3.5 %) and product density (0.016 %). For flatwise stiffness, the contribution of product thickness was 81.3 %. The second parameter was strand thickness (13.76 % contribution), followed by product density and resin content, with an influence of 4.3 % and 0.6 %, respectively. For edgewise stiffness, the contribution of product thickness was 58.85 %. The second parameter was resin content (19.97 % contribution), followed by product density (10.86 % contribution) and strand thickness (2.014 % contribution). For compression parallel to grain, the contribution of product density was 54.82 %. Strand thickness (22.55 % contribution) was the second parameter, followed by resin content and product density with an influence of 14.81 % and 6.26 %, respectively. For compression strength perpendicular to grain, the contribution of strand thickness was 80 %. The second pa-

**Table 7** Results of ANOVA analysis of effects of parameters on mechanical properties  
**Tablica 7.** Rezultati ANOVA analize utjecaja parametara na mehanička svojstva

S.O.V	DF.	F- value / F-vrijednost						
		$F_b$		E		$F_c$		$F_{v1}$
		Edge Rub	Flat Ploha	Edge Rub	Flat Ploha		⊥	
Product thickness / <i>debljina proizvoda</i>	3	0.16 <sup>ns</sup>	0.94 <sup>ns</sup>	27900*	2.4 <sup>ns</sup>	11.9 <sup>ns</sup>	3.8 <sup>ns</sup>	0.4 <sup>ns</sup>
Resin content / <i>sadržaj smole</i>	1	0.04 <sup>ns</sup>	0.17 <sup>ns</sup>	620*	2.4 <sup>ns</sup>	9.6 <sup>ns</sup>	0.0 <sup>ns</sup>	0.01 <sup>ns</sup>
Strand thickness / <i>debljina vlakana</i>	1	0.99 <sup>ns</sup>	1.8 <sup>ns</sup>	14180*	0.24 <sup>ns</sup>	14.6 <sup>ns</sup>	55 <sup>ns</sup>	0.8 <sup>ns</sup>
Product density / <i>gustoća proizvoda</i>	1	0.36 <sup>ns</sup>	0.0 <sup>ns</sup>	4430*	1.3 <sup>ns</sup>	4.07 <sup>ns</sup>	1 <sup>ns</sup>	0.01 <sup>ns</sup>
Error / <i>pogreška</i>	1	-	-	-	-	-	-	-
Total / <i>ukupno</i>	7	-	-	-	-	-	-	-

$F_b$  – bending strength / *čvrstoća na savijanje*; E – modulus of elasticity / *modul elastičnosti*;  $F_c$  – compression strength / *čvrstoća na tlak*;  $F_v$  – shear strength / *smična čvrstoća*; <sup>ns</sup> – non significant / *nije značajno*; \* – significant in 5 % confidence interval / *značajno s pouzdanosti od 5 %*

**Table 8** Results of contribution (%) of parameters on mechanical properties**Tablica 8.** Rezultati utjecaja parametara na mehanička svojstva (u postotcima)

Parameter Parametar	$F_b$		$E$		$F_c$		$F_{v1}$
	Edge / Rub	Flat / Ploha	Edge / Rub	Flat / Ploha		⊥	
Product thickness / debljina proizvoda	17.1	47.7	81.3	58.85	54.8	17	38
Resin content / sadržaj smole	1.44	3.5	0.6	19.97	14.8	0	0.35
Strand thickness / debljina vlakana	34.4	33.4	13.8	2.014	22.6	80	27
Product density / gustoća proizvoda	12.4	0.02	4.3	10.86	6.3	1.7	0.35
Error / pogreška	34	15.6	0	8.29	1.5	1.2	34
Total / ukupno	100	100	100	100	100	100	100

$F_b$  – bending strength / čvrstoća na savijanje;  $E$  – modulus of elasticity / modul elastičnosti;  $F_c$  – compression strength / čvrstoća na tlak;  $F_v$  – shear strength / smična čvrstoća

parameter was product thickness (17 %) contribution, followed by product density (1.7 % contribution). The percentage contribution of resin content was zero. Then, for shear strength parallel to grain, the contribution of product thickness was 37.8 %. The second parameter was strand thickness (27.21 % contribution), followed by resin content and product density, both with the same influence of 0.35 % (Table 8).

In Table 8, the error term contains information around three sources of variability in the results such as uncontrollable factors, factors that are not considered in the experiments, and experimental error. As a general rule of thumb, if the contribution of the error term is less than 50 %, this is a good experiment (Li *et al.*, 2013). In this study, the contribution of error (0 %, 1.2 %, 1.54 %, 8.29 %, and 15.6 % for flatwise stiffness, compression strength perpendicular to grain, compression strength parallel to grain, edgewise stiffness, and edgewise bending strength, respectively) was found to be very low (Table 8).

Therefore, it can be concluded that the proposed ANOVA analysis can satisfactorily be used to determine the relative significance of the effect of each factor on the mechanical properties. For flatwise bending strength and shear strength parallel to grain, the contribution of error term is high, but lower than 50 %, showing that the analysis for these two properties is acceptable, as well.

## 4 CONCLUSIONS

### 4. ZAKLJUČAK

In this study, the possibility of making date palm rachis-based LSL as an eco-friendly structural composite lumber and the effects of strand thickness, resin content, product density, and product thickness on the mechanical properties of the specimens were investigated using Taguchi design of experiments. Based on the results, it can be concluded that:

Date palm rachis-based LSL can be an appropriate alternative to clear wood-based and structural timber-based green structures.

Taguchi design of experiments is a powerful and cost effective technique to analyze the effects of raw material and product parameters. As a result of L8 orthogonal array, 8 experiments were carried out instead of 96.

Product thickness is the most effective parameter on the mechanical properties, followed by strand thickness.

The fourth level of product thickness (20 mm), and the second levels of resin content (10 %), strand thickness (4 mm) and product density (850 kg/m<sup>3</sup>) were optimal values for maximizing the mechanical properties of date palm rachis-based LSL.

Product thickness with an 81.3 % contribution and strand thickness with an 80 % contribution have the highest effects on the flatwise stiffness and compression strength perpendicular to grain, respectively.

### Acknowledgements – Zahvala

This work was supported by the Vice Chancellor for Research, Faculty of Natural Resources, University of Tehran, I. R. Iran [Grant Number 29971/1/2].

## 5 REFERENCES

### 5. LITERATURA

- Barnes, D., 2001: A model of the effect of strand length and strand thickness on the strength properties of oriented wood composites. *Forest Products Journal*, 51 (2): 36-46. <https://search.proquest.com/docview/214635685?accountid=45153>.
- Barrevel, W. H., 1993: Date palm products. Food and Agriculture Organization of the United Nations. *Agricultural Services Bulletin*, no. 101. Food and Agriculture Organization of the United Nations, Rome, Italy.
- Cai, Z.; Ross, R. J., 2010: Mechanical properties of wood-based composite materials. In: *Wood handbook, Wood as an engineering material*. General Technical Report FPL-GTR-190, Ross, R. J. (ed). Forest Products Laboratory, Forest Service. Department of Agriculture, Madison, W., pp: 280-291.
- Chao, C. C. T.; Krueger, R., 2007: The Date Palm (*Phoenix dactylifera* L.): Overview of Biology, Uses and Cultivation. *HortScience*, 42: 1077-1082.
- Dowson, V. H. W.; Aten, A., 1962: Dates: Handling, processing and packing. FAO Plant Production and Protection Series, no. 13. Food and Agriculture Organization Agricultural Development, Food and Agriculture Organization, Rome, Italy.
- El-Morsy, M. M. S., 1980: Studies on rachises of the Egyptian date palm leaves for hardboard production. *Fibre Science and Technology*, 13: 317-321. [https://doi.org/10.1016/0015-0568\(80\)90018-4](https://doi.org/10.1016/0015-0568(80)90018-4).
- Gaitonde, V. N.; Karnik, S. R.; Paulo Davim, J., 2007: Taguchi multiple-performance characteristics optimization in drilling of medium density fiberboard (MDF) to

- minimize delamination using utility concept. Journal of Materials Processing Technology, 196: 73-78. <https://doi.org/10.1016/j.jmatprotec.2007.05.003>.
8. Hamzacebi, C., 2016: Optimization of process parameters in oriented strand board manufacturing by Taguchi method. BioResources, 11 (3): 5987-5993. <https://doi.org/10.15376/biores.11.3.5987-5993>.
  9. Hoover, W. L.; Hunt, M. O.; Lattanzi, R. C.; Bateman, J. H.; Youngquist, J. A., 1992: Modelling mechanical properties of single-layer, aligned, mixed-hard wood strand panels. Forest Products Journal, 42: 12-18.
  10. Khiari, R.; Mhenni, M. F.; Belgasem, M. N.; Mauret, E., 2010: Chemical composition and pulping of date palm rachis and *posidonia oceanica*- A comparison with other wood and non-wood fiber sources. Bioresource Technology, 101: 775-780. <https://doi.org/10.1016/j.biortech.2009.08.079>.
  11. Kilic, M.; Celebi, G., 2006: Compression, Cleavage and Shear Resistance of Composite Construction Materials Produced from Softwoods and Hardwoods. Journal of Applied Polymer Science, 102: 3673-3678. <https://doi.org/10.1002/app.24153>.
  12. Li, T.; Cai, J.-B.; Zhou, D.-G., 2013: Optimization of the combined modification process of thermos-mechanical densification and heat treatment on Chinese fir wood. BioResources, 8 (4): 5279-5288. <https://doi.org/10.15376/biores.8.4.5279-5288>.
  13. Malanit, P.; Barbu, M. C.; Fruhwald, A., 2011: Physical and mechanical properties of oriented strand lumber made from an Asian bamboo (*Dendrocalamus asper* Backer). European Journal of Wood and Wood Products, 69: 27-36. <https://doi.org/10.1007/s00107-009-0394-1>.
  14. Mizamzul Mehat, H.; Kamaruddin, S., 2011: Optimization of mechanical properties of recycled plastic products via optimal processing parameters using the Taguchi method. Journal of Materials Processing Technology, 211: 1989-1994. <https://doi.org/10.1016/j.jmatprotec.2011.06.014>.
  15. Moses, D. M.; Prion, H. G. L.; Li, H.; Boehner, W., 2003: Composite behavior of laminated Strand lumber. Wood Science and Technology, 37: 59-77. <https://doi.org/10.1007/s00226-003-0169-5>.
  16. Nixon, R. W., 1951: The date palm: "Tree of Life" in the subtropical deserts. Economic Botany, 5: 274-301.
  17. Ozcifci, A.; Uysal, B.; Sizucen, H.; Yapici, F.; Altun, S.; Kurt, S.; Özbay, G., 2010: A comparative study on some mechanical properties of structural composite lumbers (SCL) produced from poplar (*Populus Tremula* L.) pappels. Technology, 13 (2): 85-89.
  18. Phadke, M. S., 1989. Quality Engineering using Robust Design. Prentice Hall, Englewood Cliffs, NJ., United States.
  19. Reddy, M. M.; Mohanty, A. K.; Misra, M., 2012: Optimization of tensile properties thermoplastic blends from soy and biodegradable polyesters: Taguchi design of experiments approach. Journal of Materials Science, 1-9. <https://doi.org/10.1007/s10853-011-6083-6>.
  20. Ross, P. J., 1996: Taguchi Techniques for Quality Engineering. McGraw-Hill, New York.
  21. Simpson, W. T., 1977: Model for tensile strength of oriented flakeboard. Wood Science 10 (2): 68-71.
  22. Stoffko, J., 1960: The relationship between the dimensions and geometry of wood particles and the mechanical properties of wood-particle boards. Drearsky Vyskum 5(2): 241-261.
  23. Wang, Z.; Gong, M.; Chui, Y. H., 2015: Mechanical properties of laminated strand lumber and hybrid cross laminated timber. Construction and Building Materials, 101: 622-627. <https://doi.org/10.1016/j.conbuildmat.2015.10.035>.
  24. Wang, Z.; Zhou, J.; Gong, M.; Chui, Y. H.; Lu, X., 2016: Evaluation of Modulus of Elasticity of Laminated Strand Lumber by Non-Destructive Evaluation Technique. BioResources, 11 (1): 626-633. <https://doi.org/10.15376/biores.11.1.626-633>.
  25. Weight, S. W., 2007: A novel wood-strand composite laminate using small-diameter timber. MSc. Thesis in Civil Engineering, Department of Civil and Environmental Engineering, Washington State University, Pullman, WA, United States.
  26. Xing, C.; Deng, J.; Zhang, S. Y., 2007: The effect of thermo-mechanical refining on properties of MDF made from black spruce bark. Wood Science and Technology, 41: 329-338. <https://doi.org/10.1007/s00226-006-0108-3>.
  27. Zaid, A.; De Wet, P. F., 2002: Botanical and systematic description of the date palm. In: Date palm cultivation, UNOPS – Date Palm Research & Development Programme United Arab Emirates, Zaid, A. (ed.). Food and Agricultural Organization of the United Nations, Rome, Italy.
  28. \*\*\*ASTM D1037, 2003: Standard Test Methods for Evaluating Properties of Wood-Base Fibre and Particle Panel Materials. ASTM International. West Conshohocken, PA.
  29. \*\*\*ASTM D 5456, 2003: Standard Specification for Evaluation of Structural Composite Lumber Products. ASTM International. West Conshohocken, PA.
  30. \*\*\*ASTM D 198, 2003: Standard Test Methods of Static Tests of Lumber in Structural Sizes. ASTM International. West Conshohocken, PA.
  31. \*\*\*ASTM D143, 2003: Standard Test Methods for Small Clear Specimens of Timber, ASTM International. West Conshohocken, PA.

**Corresponding address:**

MASOUD SHAFIE

University of Tehran  
 Faculty of Natural Resources  
 Department of Wood and Paper Science  
 and Technology  
 P. O. Box: 3158777878, Karaj, I. R. IRAN  
 e-mail: masoudshafie2014@ut.ac.ir



HRVATSKA KOMORA  
INŽENJERA ŠUMARSTVA  
I DRVNE TEHNOLOGIJE

# HRVATSKA KOMORA INŽENJERA ŠUMARSTVA I DRVNE TEHNOLOGIJE

Osnovana je na temelju Zakona o Hrvatskoj komori inženjera šumarstva i drvne tehnologije.

Komora je samostalna i neovisna strukovna organizacija koja obavlja povjerene joj javne ovlasti, čuva ugled, čast i prava svojih članova, skrbi da ovlaštene inženjeri obavljaju svoje poslove savjesno i u skladu sa zakonom, promiče, zastupa i usklađuje njihove interese pred državnim i drugim tijelima u zemlji i inozemstvu.

## Članovi komore:

inženjeri šumarstva i drvne tehnologije koji obavljaju stručne poslove iz područja šumarstva, lovstva i drvne tehnologije.

## Stručni poslovi:

projektiranje, izrada, procjena, izvođenje i nadzor radova iz područja uzgajanja, uređivanja, iskorištavanja i otvaranja šuma, lovstva, zaštite šuma, hortikulture, rasadničarske proizvodnje, savjetovanja, ispitivanja kvalitete proizvoda, sudskoga vještačenja, izrade i revizije stručnih studija i planova, kontrola projekata i stručne dokumentacije, izgradnja uređaja, izbor opreme, objekata, procesa i sustava, stručno osposobljavanje i licenciranje radova u šumarstvu, lovstvu i preradi drva.

## Zadaci Komore:

- promicanje razvoja struke i skrb o stručnom usavršavanju članova,
- poticanje donošenja propisa kojima se utvrđuju javne ovlasti Komore,
- reagiranje struke na pripremu propisa iz područja šumarstva, lovstva i drvne tehnologije,
- suradnja s nadležnim institucijama i zastupanje struke u odnosu prema njima,
- organizacija stručnoga usavršavanja,
- zastupanje interesa svojih članova,
- izdavanje pečata i iskaznice ovlaštenim inženjerima,
- briga i nadzor poštivanja kodeksa strukovne etike,
- osiguravanje članova Komore za štetu koja bi mogla nastati investitorima i trećim osobama i sl.

Članovima Komore izdaje se rješenje, pečat i iskaznica ovlaštenoga inženjera.

Za uspješno obavljanje zadataka te za postizanje ciljeva ravnopravnoga i jednakovrijednoga zastupanja struka udruženih u Komoru, članovi Komore organizirani su u razrede:

- Razred inženjera šumarstva
- Razred inženjera drvne tehnologije

HRVATSKA KOMORA INŽENJERA ŠUMARSTVA I DRVNE TEHNOLOGIJE

Prilaz Gjüre Deželića 63  
10000 ZAGREB

telefon:  
++ 385 1 376-5501  
e-mail:  
info@hkisdt.hr

www.hkisdt.hr

# Effect of Veneer Drying Process on Some Technological Properties of Polystyrene Composite Plywood Panels

## Utjecaj procesa sušenja furnira na tehnološka svojstva kompozitnih uslojenih drvnih ploča vezanih polistirenom

Original scientific paper • Izvorni znanstveni rad

Received – prispjelo: 24. 9. 2018.

Accepted – prihvaćeno: 20. 11. 2019.

UDK: 630\*812.31; 630\*812.71; 630\*832.281.7; 630\*832.282; 630\*863

<https://doi.org/10.5552/drvind.2019.1844>

**ABSTRACT** • The aim of study was to determine the effect of veneer drying process on some technological properties of polystyrene composite plywood panels. For this reason, 2 mm-thick rotary cut veneers were obtained from beech (*Fagus orientalis*, Lipsky), Alder (*Alnus glutinosa* subsp. *Barbata*) and Scots pine (*Pinus sylvestris* L.) logs. The veneers obtained from three different wood species were divided into two groups to produce polystyrene composite plywood (PCP) and traditional plywood. While PCP was produced both air dried (at 20 °C) and oven dried (at 110 °C), the veneer sheets for production of traditional plywood were dried at 110 °C until reaching 7 % equilibrium moisture content. Two different types of polystyrene with high density (30 kg/m<sup>3</sup>) and low density (16 kg/m<sup>3</sup>) were used as bonding material for PCP panel production. The urea-formaldehyde adhesive was used as a bonding material for traditional plywood panels. Bonding shear strength, bending strength, modulus of elasticity and density of plywood and polystyrene composite plywood panels were investigated. It was found that the technological properties observed in the study of composite plywood panels manufactured with natural dried veneers gave similar results compared to those of composites produced with technical dried veneers.

**Keywords:** polystyrene composite plywood (PCP), veneer drying, mechanical properties, styrofoam

**SAŽETAK** • Cilj ovog istraživanja bio je utvrditi utjecaj procesa sušenja furnira na tehnološka svojstva kompozitnih uslojenih drvnih ploča vezanih polistirenom. Ljušteni furniri debljine 2 mm pripremljeni su od trupaca drva bukve (*Fagus orientalis*, Lipsky), drva johe (*Alnus glutinosa* subsp. *Barbata*) i drva običnog bora (*Pinus sylvestris* L.). Furniri od tri različite vrste drva podijeljeni su u dvije skupine kako bi se proizvela kompozitna uslojena ploča vezana polistirenom (PCP) i tradicionalna uslojena ploča. Za proizvodnju PCP ploča rabljeni su furniri sušeni na zraku (na 20 °C) i u sušioniku (na 110 °C), a za proizvodnju tradicionalne uslojene ploče upotrijebljeni su furniri sušeni pri 110 °C sve do postizanja ravnotežnog sadržaja vode od 7 %. Kao vezivo za PCP ploče uporabljene su dvije vrste polistirena – polistiren velike gustoće (30 kg/m<sup>3</sup>) i polistiren male gustoće (16 kg/m<sup>3</sup>). Za proizvodnju

<sup>1</sup> Author is lecturer at Karadeniz Technical University, Arsin Vocational School, Materials and Material Processing Technologies, Trabzon, Turkey. <sup>2</sup> Authors are research assistant, associate professor and professor at Karadeniz Technical University, Faculty of Forestry, Department of Forest Industry Engineering, Trabzon, Turkey.

<sup>1</sup> Autor je nastavnik Tehničkog sveučilišta Karadeniz, Strukovna škola Arsin, Materijali i tehnologije prerade materijala, Trabzon, Turska.

<sup>2</sup> Autori su istraživač, izvanredni profesor i profesor Tehničkog sveučilišta Karadeniz, Šumarski fakultet, Zavod za inženjerstvo u šumarstvu, Trabzon, Turska.

tradicionalne uslojene ploče kao vezivo je služilo urea-formaldehidno ljepilo. Istraživani su smična čvrstoća lijepjenog spoja, čvrstoća na savijanje, modul elastičnosti te gustoća uslojene i kompozitne uslojene ploče vezane polistirenom. Utvrđeno je da kompozitne uslojene drvene ploče proizvedene od prirodno sušenih furnira imaju slična promatrana tehnološka svojstva kao i kompoziti proizvedeni od tehnički sušenih furnira.

**Cljučne riječi:** kompozitna uslojena ploča vezana polistirenom (PCP), sušenje furnira, mehanička svojstva, stiropor

## 1 INTRODUCTION

### 1. UVOD

Production of wood-based composites is one of the largest manufacturing businesses worldwide. They are widely used in diverse fields, including windows and door frames, floors and interior panels in cars that contribute to their popularity (Fang *et al.*, 2013). Plywood, as one of the most important wood-based composite panels, has many areas of use (Demirkir *et al.*, 2013). As compared to solid wood, the chief advantages of plywood are that properties along the length of the panel are nearly equal to properties along the width, resulting in greater resistance to splitting, and the form that permits many applications, where large sheets are desirable (Aydin and Colakoglu, 2008). Formaldehyde-based adhesives such as urea- (UF), phenol-and melamine-formaldehyde resins are widely used in the plywood manufacturing industry (Luo *et al.*, 2015). Additionally, formaldehyde is a potential human carcinogen and, because of its high risk level, it is classified differently than most other pollutants (Bohm *et al.*, 2012). Also, in 1995 the International Agency for Research on Cancer (IARC) classified formaldehyde, in terms of human health, as "Possible Carcinogenic Substances" class and the ratio of formaldehyde that can be released from wood-based materials was limited in most of countries (IARC, 2004; Colakoglu, 1993). After this area was investigated comprehensively, in June 2004 IARC removed formaldehyde from "Possible Carcinogenic Substances" class and identified it as directly carcinogenic to humans (Jianying *et al.*, 2010). As a result, an urgent need has arisen for the development of formaldehyde-free wood adhesives. Significant efforts have been made to reduce or replace formaldehyde contents in adhesive formulations. Although some of these new adhesives have already been used in industrial applications, their supply is limited, which may be due to high modification costs or some weak properties, such as low water-resistance (Fang *et al.*, 2013). Therefore, the chemicals and adhesives used for reducing the formaldehyde emission should be cheap and easily accessible. They should also meet the optimum values described in the standards concerning the technological properties of wood-based panels (Colak *et al.*, 2016). The use of polystyrene materials in plywood manufacturing instead of formaldehyde based adhesives is another method. Disposal of a large amount of abandoned polystyrene in the developed countries is a major concern. Polystyrene composite plywood (PCP) can be manufactured without synthetic resins such as urea-formaldehyde or phenol-formaldehyde (Demirkir *et al.*, 2013; Hu *et al.*, 2005). Therefore, PCP manufacturing can be suitable

both environmentally and economically. Furthermore, PCP manufacturing process does not need a gluing machine or the preparation of glue mixture. So, the production process has been simplified. Demirkir *et al.* (2013) stated in their studies that polystyrene wastes could be evaluated in plywood production as a bonding material. However, some revisions should be made in PCP manufacturing process to increase productivity, since no adhesive is used in the process.

Veneer drying is one of the most important steps of plywood manufacturing process. As known, the aim of the drying process is to reduce moisture content of veneers to obtain suitable values for gluing. Before the gluing process, moisture content of all veneers should be below 7 % (Demirkir *et al.*, 2013; Lutz, 1978). Drying temperature influences both physical and chemical surface properties of veneer and hence also its thermal conductivity characteristics. The PCP manufacturing process may not need drying process, since no adhesives are used in the production. Numerous studies have been carried out for the effects of veneer drying temperatures on bondability of veneer surfaces (Christiansen, 1990; Lehtinen, 1998; Demirkir *et al.*, 2016), surface-inactivation and bond strength relationship (Demirkir *et al.*, 2016; Frihart and Hunt, 2010) and optimum conditions for surface preparation (Demirkir *et al.*, 2016; River *et al.*, 1991). However, there are few studies about the effect of the drying process on the technological properties of polystyrene composite panels. Veneer drying often becomes a production bottleneck because of inefficient equipment and methods (Baldwin, 1995; Aydin and Colakoglu, 2005). The drying process accounts for some 70 % of the thermal energy consumed in plywood production and approximately 60 % of the mill's total energy requirement.

Therefore, it is also important to present the economic effect of veneer drying process on PCP manufacturing. The aim of this study was to determine the effect of veneer drying process on some technological properties of the PCP panel.

## 2 MATERIALS AND METHODS

### 2. MATERIJALI I METODE

In this experimental study, 2 mm-thick rotary cut veneers with the dimensions of 500 mm by 500 mm were obtained from beech (*Fagus orientalis*, Lipsky), alder (*Alnus glutinosa* subsp. *barbata*) and Scots pine (*Pinus sylvestris* L.) logs. While alder veneers were manufactured from freshly cut logs, beech and Scots pine logs were steamed for 12 h before veneer production. A rotary peeler with a maximum horizontal holding capacity of 80 cm was used for veneer manufactur-

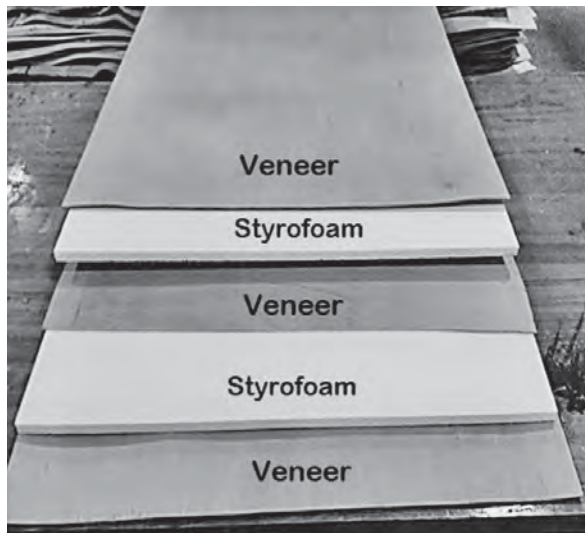

**Figure 1** Structural design of three-layer polystyrene composite plywood panels

**Slika 1.** Konstruktivski izgled troslojne kompozitne uslojene ploče vezane polistirenom

ing. The horizontal opening between knife and nose bar was 85 % of the veneer thickness, and the vertical opening was 0.5 mm in the rotary cutting process. The veneers obtained from three different wood species were divided into two groups to produce polystyrene composite plywood and traditional plywood. While PCP was produced both air dried (at 20 °C) and oven dried (at 110 °C), the veneer sheets for production of traditional plywood were dried at 110 °C until reaching 7 % equilibrium moisture content. The veneers used for PCP panels had a moisture content of 10-12 % (air dried at 20 °C) and 5-7 % (at 110 °C). After drying, polystyrene composite plywood panel drafts were formed. Polystyrene composite panels were manufactured with 3 layers as shown in Figure 1. The thickness of polystyrene type used in this study was 10 mm. The high density polystyrene (HDP - 30 kg/m<sup>3</sup>) and low density polystyrene (LDP - 16 kg/m<sup>3</sup>) were used for PCP panel production. Three-ply-plywood panels, 6 mm thick, were manufactured from polystyrene as shown in Figure 1. Pressing time and temperature were 8 min and 150 °C, respectively.

Three-ply-plywood panels, 6 mm thick, were manufactured by using urea formaldehyde resin. The formulations of adhesive mixture used for traditional plywood manufacturing are given in Table 1.

The glue mixture was applied at a rate of 160 g/m<sup>2</sup> to a single surface of veneer by using a four-roller glue spreader. Hot press pressure of 12 kg/cm<sup>2</sup> for beech and alder panels and 8 kg/cm<sup>2</sup> for scots pine panels was applied, while hot pressing time and temperature were 6 min and 110 °C, respectively. Two replicate panels were manufactured for all test groups. Test panels were conditioned at 20 °C temperature and 65 % relative humidity prior to testing.

Bonding shear strength test was performed according to EN 314-1 standard. Before the bonding shear strength test, samples were immersed for 24 h in water at 20 °C. Bending strength and modulus of elas-

**Table 1** Formulations of UF glue mixture used for manufacturing of plywood

**Tablica 1.** Formulacija UF ljepila upotrijebljenoga za proizvodnju uslojene ploče

Glue type <i>Vrsta ljepila</i>	Ingredients of glue mixture <i>Sastojci ljepila</i>	Parts by weight <i>Težinski udio</i>
UF	UF resin (with 55 % solid content) / <i>UF smola (s 55 % suhe tvari)</i>	100
	Wheat flour / <i>pšenično brašno</i>	30
	Hardener - NH <sub>4</sub> Cl (with 15 % concentration) / <i>otvrdnjivač - NH<sub>4</sub>Cl (15 %-ne koncentracije)</i>	10

ticity values of panels were evaluated according to EN 310 standard. Density values of the panels were determined according to EN 323 standard. Twenty specimens obtained randomly from the two replicate panels of each group were used for the evaluation of bonding shear strength, bending strength, modulus of elasticity and density.

Multifactor analysis of variance was performed for statistical evaluation of the changes in mechanical properties depending on the wood species, glue types, and number of plies of panels. After ANOVA, Student–Newman–Keuls test was used at 95 % confidence level to compare the mean values of variance sources.

### 3 RESULTS AND DISCUSSION

#### 3. REZULTATI I RASPRAVA

As can be seen from Table 2, the effects of wood species, binder types and veneer drying process on mechanical and physical properties were found statistically significant. Student–Newman–Keuls test was used at 95 % confidence level to compare the mean values of variance sources.

Mean values of bonding strength of PCP panels and traditional plywood panel groups are given in Figure 2.

As can be seen from Table 2, the effect of binder type on the bonding strength of composite panels is significant at 95 % confidence level. As seen from Figure 2, the bonding strength values of plywood panels manufactured with UF adhesive were found to be the highest. It was also found that the bonding strength values of Polystyrene composite plywood panels with high density Styrofoam were lower than those of composite panels manufactured with low density polystyrene. Demirkir *et al.* (2013) stated that, since PCP panels produced with low density polystyrene could be pressed easily and homogeneously, stronger fastening could be achieved between veneer and polystyrene (Demirkir *et al.*, 2013).

The examination of the effect of wood species on bonding strength of the panels showed that the composite plywood panels manufactured from beech veneers gave the highest bonding strength values. The



**Table 2** Results of Student-Newman-Keuls test at 95 % confidence level for mechanical properties**Tablica 2.** Rezultati Student-Newman-Keulsova testa za mehanička svojstva s pouzdanošću od 95 %

Properties <i>Svojstva</i>	Factors <i>Čimbenici</i>	LS Mean <i>LS srednja vrijednost</i>	Homogenous groups <i>Homogene skupine</i>
Bonding shear strength <i>smična čvrstoća lijepljenog spoja</i>	Veneer drying process / <i>Proces sušenja furnira</i>		
	Technical drying / <i>tehničko sušenje</i>	1.04	a
	Air dried / <i>prirodno sušenje</i>	0.88	a
	Wood species / <i>Vrsta drva</i>		
	Beech / <i>drvo bukve</i>	1.26	a
	Alder / <i>drvo johe</i>	0.85	b
	Pine / <i>drvo bora</i>	0.76	c
	Binder types / <i>Vrsta veziva</i>		
	HDP	0.77	a
	LDP	1.14	b
UF	2.09	c	
Bending strength <i>čvrstoća na savijanje</i>	Veneer drying process / <i>Proces sušenja furnira</i>		
	Technical drying / <i>tehničko sušenje</i>	60.64	a
	Air dried / <i>prirodno sušenje</i>	62.25	a
	Wood species / <i>Vrsta drva</i>		
	Beech / <i>drvo bukve</i>	89.17	a
	Alder / <i>drvo johe</i>	56.01	b
	Pine / <i>drvo bora</i>	39.14	c
	Binder types / <i>Vrsta veziva</i>		
	HDP	46.90	a
	LDP	75.99	b
UF	83.20	b	
Modulus of elasticity <i>modul elastičnosti</i>	Veneer drying process / <i>Proces sušenja furnira</i>		
	Technical drying / <i>tehničko sušenje</i>	5061.26	a
	Air dried / <i>prirodno sušenje</i>	5163.27	b
	Wood species / <i>Vrsta drva</i>		
	Beech / <i>drvo bukve</i>	6819.63	a
	Alder / <i>drvo johe</i>	4793.14	b
	Pine / <i>drvo bora</i>	3724.03	c
	Binder types / <i>Vrsta veziva</i>		
	HDP	4491.77	a
	LDP	4793.14	b
UF	6453.65	c	
Density / <i>Gustoća</i>	Veneer drying process <i>Proces sušenja furnira</i>		
	Technical drying / <i>tehničko sušenje</i>	0.591	a
	Air dried / <i>prirodno sušenje</i>	0.604	a
	Wood species / <i>Vrsta drva</i>		
	Beech / <i>drvo bukve</i>	0.678	a
	Alder / <i>drvo johe</i>	0.586	b
	Pine / <i>drvo bora</i>	0.530	c
	Binder types / <i>Vrsta veziva</i>		
	HDP	0.585	a
	LDP	0.610	b
UF	0.636	c	

reason lies in the fact that beech wood has a higher density. It is also known that bonding strength of plywood panels is improved with increasing wood density (Demirkir, 2012).

Bonding strength between wood elements affects all mechanical properties of the wood-based panel products. For maximum adhesive bond strength, the liquid adhesive must wet the wood surface and penetrate into the wood. Adhesive molecules must contact directly with wood molecules to provide the best me-

chanical inter locking and inter molecular attraction (Frihart and Hunt, 2010). In the present study, UF adhesive had the best wetting properties among all binding systems used. Therefore, the layers of UF bonded plywood panels may be better bonded to each other in the same production conditions (Demirkir *et al.*, 2013).

Mean values of bending strength of PCP panels and traditional plywood panel groups are given in Figure 3.

The composite panels manufactured with UF adhesive gave the best bending strength values according

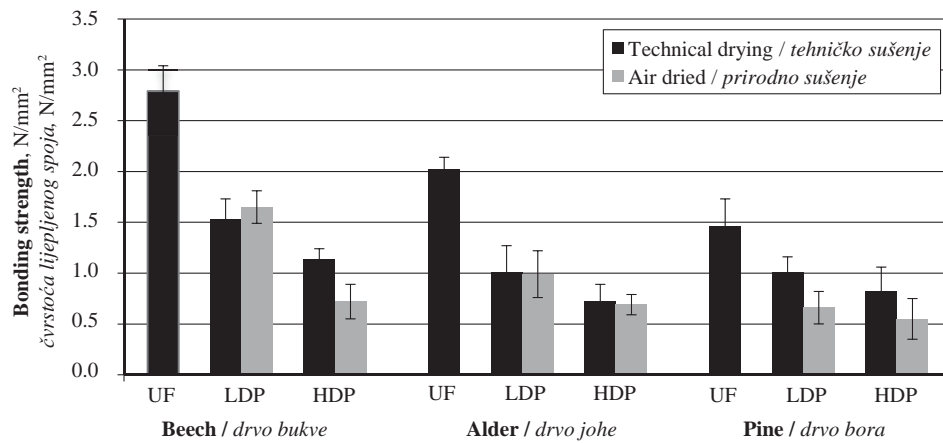

**Figure 2** The average bonding strength values of test panels  
**Slika 2.** Srednje vrijednosti čvrstoće lijepjenog spoja ispitivanih ploča

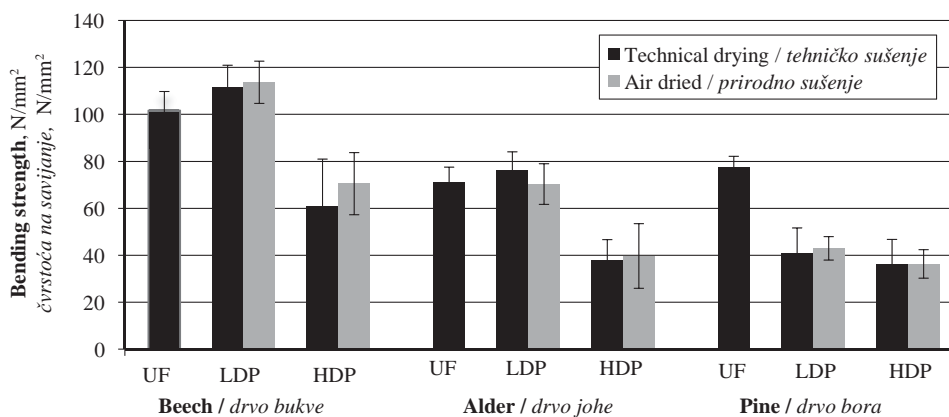

**Figure 3** The average bending strength values of test panels  
**Slika 3.** Srednje vrijednosti čvrstoće ispitivanih ploča na savijanje

to statistical analysis in Table 2. The bending strength values of the composites produced with low density polystyrene were higher than those of the composites with HDP. In literature, it was determined that binder types affected the bending strength values of wood-based composite panels.

When the effect of wood species on the bending strength of the composites was analyzed, the best bending strength values were obtained from beech composite panels. These results were expected because of its higher density among species used in the study. It is known that mechanical properties are improved with increasing density (Wood Handbook, 2010). It was determined that bonding strength values of beech composite plywood panels were the highest in this study. It was stated that a good bonding between wood and adhesive caused the better bending strength (Aydin and Demirkir, 2010). It is expected that a good mechanical bonding will also have a positive effect on bending strength (Demirkir, 2012; Aydin, 2004a). At the same pressing conditions, the glue line of panels manufactured with LDP might be thinner, so the surfaces of plies come closer than those of the panels manufactured with HDP. Therefore, the panels manufactured with LDP will have higher mechanical properties than the panels manufactured with HDP. Kurt and Cil (2012) stated that the glue line thickness directly affects the

strength of wood composites and that the press pressure is one of the main factors to control the glue line thickness. They also indicated that one of the most important reasons for the occurrence of a thick glue line is insufficient pressure in the manufacturing process and that, generally, thick glue lines of many common adhesives can cause the strength loss (Kurt and Cil, 2012).

The bending strength values of all composites met the requirements (40 N/mm<sup>2</sup>) given in DIN 68705-3 except for some panel groups as seen in Figure 3. Also, the mean values obtained for the bending strength of plywood composite panels were higher than the limit values (27.4 N/mm<sup>2</sup>) indicated in Japanese standards (Nanami *et al.*, 2000).

Mean values of modulus of elasticity of PCP panels and traditional plywood panel groups are given in Figure 4.

The effect of binder type on modulus of elasticity was significant at 95 % confidence level. The panels manufactured with UF resin gave the highest modulus of elasticity values. It was shown as Figure 4 the modulus of elasticity values of plywood panels produced with LDP were higher than those of the panels with HDP. It was stated that the effect of adhesive and binder types on the modulus of elasticity of plywood panels was significant (Colak, 2002; Ozturk, 2012; Demir, 2014). In a former study researching some technologi-

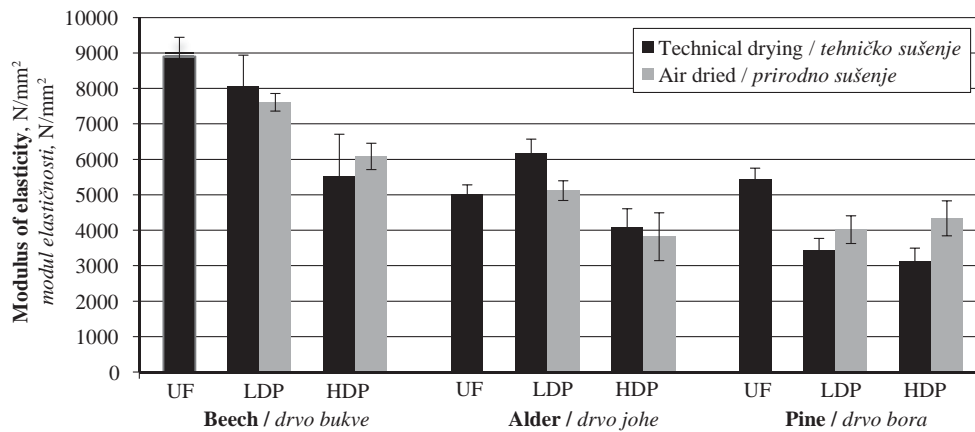

**Figure 4** The average modulus of elasticity values of test panels  
**Slika 4.** Srednje vrijednosti modula elastičnosti ispitivanih ploča

cal properties of plywood panels manufactured with different polystyrene types, it was found that polystyrene density effected the modulus of elasticity values of the panels (Demirkir *et al.*, 2016). It was also determined that plywood and LVL panels produced with Phenol Formaldehyde resin gave better mechanical characteristics than panels with Melamine Urea Formaldehyde resin (Demirkir, 2012; Tan, 2011).

The highest modulus of elasticity values were obtained from plywood panels manufactured with beech veneer similar to bending strength. In literature, it was indicated that there was an effect of wood species on the modulus of elasticity of plywood. It was also stated that modulus of elasticity values of plywood panels were getting higher with increasing the modulus of elasticity of raw wood used in veneer manufacturing (Demirkir, 2012; Ors *et al.*, 2002).

Mean values of density of PCP panels and traditional plywood panel groups are given in Figure 5.

The highest density values were obtained from the plywood panels bonded with UF resin for both three wood species. The average density values of panels manufactured with HDP were lower than those of panels manufactured with LDP. As the same pressure was applied to all groups, the plywood panels bonded with LDP may become thinner, which results in higher

density of the panel (Demirkir *et al.*, 2013). Similar results were found by Demirkir *et al.* (2013).

The density values of beech plywood panels were higher than those of pine plywood. This effect can be due to the raw materials density, which affects directly the plywood density. Plywood density is mainly dependent on the density of wood species used for the panel production (Rahman *et al.*, 2012). Rahman *et al.* (2012) and Alam *et al.* (2012) stated that the difference in density values of plywood panels might depend on the raw material density in the same manufacturing conditions (Rahman *et al.*, 2012; Alam *et al.*, 2012). In addition to the raw material density, the glue type and mixture also contribute to plywood density (River *et al.*, 1991). However, these effects are lower than those of the wood type (Ors *et al.*, 2002).

The green veneers are dried to an average MC that is compatible with the adhesive system used to bond the panels. When veneers are bonded with adhesives to produce plywood, the water in adhesive mixture is absorbed by veneers (Aydin, 2004b). Due to polystyrene, which was used as adhesive with no water content, MC of the veneers did not change in the plywood manufacture. According to statistical analysis, the technical and air-dried processes did not affect the mechanical strength values of panels except the modulus of elasticity.

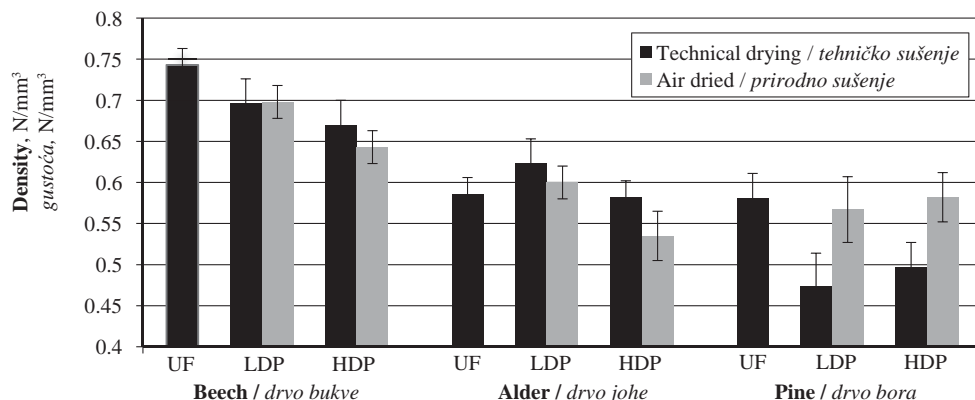

**Figure 5** The average density values of test panels  
**Slika 5.** Srednje vrijednosti gustoće ispitivanih ploča

## 4 CONCLUSIONS

### 4. ZAKLJUČAK

In the present study, the technological properties of PCP panels manufactured with air dried veneers and technical dried veneers were generally found similar. 70 % of thermal energy used in plywood manufacturing was used in the veneer drying process. The current study showed that composite plywood panels could be manufactured with HDP and LDP binders without veneer drying process. Considering that the plant's total energy needs are about 60 % (FAO, 1990; Aydin, 2004b), plywood plants could achieve an energy saving of 60 percent.

### Acknowledgements – Zahvala

The authors acknowledge the financial support for this study by TUBITAK (The Scientific and Technical Research Council of Turkey) (Project No: 2140743).

## 5 REFERENCES

### 5. LITERATURA

1. Alam, D. M.; Islam, M. N.; Rahman, K. S.; Alam, M. R., 2012: Comparative study on physical and mechanical properties of plywood produced from eucalyptus (*Eucalyptus camaldulensis* Dehn.) and simul (*Bombax ceiba* L.) veneers. Research Journal of Recent Sciences, 1 (9): 54-58. <https://doi.org/10.1007/s10086-010-1149-7>.
2. Aydin, I., 2004a: Effects of some manufacturing conditions on wettability and bonding of veneers obtained from various wood species. PhD Thesis, KTU Graduate School of Natural and Applied Sciences, Trabzon, Turkey (in Turkish).
3. Aydin, I., 2004b: Surface inactivation in veneer drying process and its effects on bonding strength. Journal of Artvin Forestry Faculty, 1-2: 1-8.
4. Aydin, I.; Colakoglu, G., 2005: Formaldehyde emission, surface roughness, and some properties of plywood as function of veneer drying temperature. Drying Technology, 23 (5): 1107-1117. <https://doi.org/10.1081/DRT-200059142>.
5. Aydin, I.; Colakoglu, G., 2008: Variations in bending strength and modulus of elasticity of spruce and alder plywood after steaming and high temperature drying. Mechanics of Advanced Materials and Structures, 15: 371-374. <https://doi.org/10.1080/15376490801977692>.
6. Aydin, I.; Demirkir, C., 2010: Activation of spruce wood surfaces by plasma treatment after long terms of natural surface inactivation. Plasma Chemistry and Plasma Processing, 30: 697-706. <https://doi.org/10.1007/s11090-010-9244-5>.
7. Baldwin, R. F., 1995: Veneer drying and preparation. In Plywood and Veneer-Based Products, Chapter 15, Miller Freeman Books: San Francisco.
8. Bohm, M.; Salem, M. Z. M.; Srba, J., 2012: Formaldehyde emission monitoring from a variety of solid wood, plywood, blockboard and flooring products manufactured for building and furnishing materials. Journal of Hazardous Materials, 221-222: 68-79. <https://doi.org/10.1016/j.jhazmat.2012.04.013>.
9. Christiansen, A. W., 1990: How over drying wood reduces its bonding to phenol-formaldehyde adhesives: a critical review of the literature. Part I – physical responses. Wood and Fiber Science, 22: 441-459.

10. Colak, S., 2002: The effect of impregnation procedure at plywood on technological properties, formaldehyde and acid emission of plywood, PhD Thesis. KTU Graduate School of Natural and Applied Sciences, Trabzon, Turkey (in Turkish).
11. Colak, S.; Ozturk, H.; Demir, A., 2016: Some technological properties of plywood produced using with nylon waste as adhesive. İleri Teknoloji Bilimleri Dergisi, 5 (2): 21-27 (in Turkish).
12. Colakoglu, G., 1993: Effect of the production parameter on formaldehyde emission and technical properties of plywood, PhD Thesis. KTU Graduate School of Natural and Applied Sciences, 21 p., Trabzon (in Turkish).
13. Demir, A., 2014: The effects of fire retardant chemicals on thermal conductivity of plywood produced from different wood species, Master Thesis. KTU Graduate School of Natural and Applied Sciences, Trabzon, Turkey (in Turkish).
14. Demirkir, C., 2012: Using possibilities of pine species in Turkey for structural plywood manufacturing, PhD Thesis. KTU Graduate School of Natural and Applied Sciences, Trabzon, Turkey (in Turkish).
15. Demirkir, C.; Colak, S.; Aydin, I., 2013: Some technological properties of wood – Styrofoam composite panels. Composites, Part B: Engineering, 55: 513-517. <https://doi.org/10.1016/j.compositesb.2013.07.024>.
16. Demirkir, C.; Ozturk, H.; Colakoglu, G., 2016: Some technological properties of polystyrene composite plywood produced from different density polystyrene. 2. International Furniture Congress, 13-15 October. Muğla, Turkey.
17. Fang, L.; Chang, L.; Guo, W.; Ren, Y.; Wang, Z., 2013: Preparation and characterization of wood-plastic plywood bonded with high density polyethylene film. European Journal of Wood and Wood Products, 71: 739-746. <https://doi.org/10.1007/s00107-013-0733-0>.
18. Frihart, C. R.; Hunt, C. G., 2010: Adhesives with wood materials, bond formation and performance, Wood Handbook – wood as an engineering material. General Technical Report FPL-GTR-190. Madison, WI: U.S. Department of Agriculture, Forest Service, Forest Products Laboratory.
19. Hu, Y.; Nakao, T.; Nakai, T.; Gu, J.; Wang, F., 2005: Vibrational properties of wood plastic plywood. Journal of Wood Science, 51:13-7. <https://doi.org/10.1007/s10086-003-0624-9>.
20. Jianying, X.; Tao, J.; Yingyan, G.; Min, Z.; Xia, Z., 2010: Reduction of formaldehyde emission of wood-based panels. Bioinformatics and Biomedical Engineering (iCBBE), 2010 4<sup>th</sup> International Conference on (18-20 June), 1-3, Chengdu, China.
21. Kurt, R.; Cil, M., 2012: Effects of press pressures on glue-line thickness and properties of laminated veneer lumber glued with phenol formaldehyde adhesive. BioResources, 7 (49): 5346-5354. <https://doi.org/10.15376/biores.7.3.4341-4349>.
22. Lehtinen, M., 1998: Effect of high manufacturing temperatures on mechanical properties of veneers and plywood. International Conference of COST Action E8 – Wood Mechanics, May 11-12, Florence, Italia.
23. Luo, J.; Luo, J.; Gao, Q.; Li, J., 2015: Effects of heat treatment on wet shear strength of plywood bonded with soybean meal-based adhesive. Industrial Crops and Products, 63: 281-286. <https://doi.org/10.1016/j.indcrop.2014.09.054>.
24. Lutz, J. F., 1978: Wood Veneer: Log Selection, Cutting, and Drying, U.S. Department of Agriculture, Technical Bulletin No. 1577.

25. Nanami, N.; Shibusawa, T.; Sato, M.; Arima, T.; Kawai, M., 2000: Durability assessment of wood-framed walls and mechanical properties of plywood in use. In: Proceedings of the World Conference on Timber Engineering. University of British Columbia.
26. Ors, Y.; Colakoglu, G.; Aydin, I.; Colak, S., 2002: Comparison of some technical properties of plywood produced from beech, okoume and poplar rotary cut veneers in different combinations. *Journal of Polytechnic*, 5 (3): 257-265.
27. Ozturk, H., 2012: Some technological properties of plywood panels manufactured from alder (*Alnus glutinosa* subsp. *barbata* (c.a. meyer.) yalt.) species grown in different regions, Master Thesis. KTU Graduate School of Natural and Applied Sciences, Trabzon, Turkey (in Turkish).
28. Rahman, K. S.; Alam, D. M.; Islam, M. N., 2012: Some physical and mechanical properties of bamboo mat-wood veneer plywood. *International Research Journal of Biological Sciences*, 1 (12): 61-64.
29. River, B. H.; Gillespie, R. H.; Vick, C. B., 1991: Wood as an adherent. In: Minford, J. D. (ed.). *Treatise on adhesion and adhesives*. New York, NY: Marcel Dekker, Inc. 230 p., vol. 7.
30. Tan, H., 2011: Some technological properties of LVL and plywood produced from logs of spruce and fir growing in distinct regions, PhD Thesis. KTU Graduate School of Natural and Applied Sciences, Trabzon, Turkey (in Turkish).
31. \*\*\*FAO, 1990: Energy Conservation in the Mechanical Forest Industries: FAO Forestry Paper, Food and Agriculture Organization of the United Nations, Rome.
32. \*\*\*EN 310, 1993: Wood-based panels. Determination of modulus of elasticity in bending and of bending strength. European Standards, Brussels.
33. \*\*\*EN 323, 1993: Wood-Based panels. Determination of density. European Standards, Brussels.
34. \*\*\*DIN 68705-3, 2003: Structure Plywood. German Standards Institute, Verlag.
35. \*\*\*EN 314-1, 2004: Plywood – Bonding quality. Part 1: Test methods. European Standards, Brussels.
36. \*\*\*IARC, 2004: Overall evaluations on carcinogenicity to humans. In: As evaluated in IARC monographs, vol. 1. Lyon, France: International Agency for Research on Cancer.
37. \*\*\*Wood Handbook, 2010: Wood as an engineering material. Madison, Wisconsin: United States Department of Agriculture, Forest Products Laboratory, General Technical Report FPL-GTR-190.

**Corresponding address:**

Assoc. Prof. CENK DEMIRKIR, PhD

Karadeniz Technical University  
Faculty of Forestry  
Department of Forest Industry Engineering  
61080 Trabzon, TURKEY  
e-mail: cenk@ktu.edu.tr

# Surface Roughness and Wettability of Surface Densified Heat-Treated Norway Spruce (*Picea abies* L. Karst.)

## Hrapavost i stupanj kvašenja ugušćene površine pregrijane smrekovine (*Picea abies* L. Karst.)

### Original scientific paper • Izvorni znanstveni rad

Received – prispjelo: 3. 12. 2018.

Accepted – prihvaćeno: 20. 11. 2019.

UDK: 630\*827.4; 630\*812.24

<https://doi.org/10.5552/drvind.2019.1852>

**ABSTRACT** • Surface roughness and wettability of the heat-treated and then surface densified spruce (*Picea abies* L. Karst.) wood were measured to determine the effect of densification and heat-treatment on wood surface properties. The process of heat-treatment with an initial vacuum was performed in a vacuum chamber on oven dried lamellas with dimensions of 630 mm (longitudinal direction) x 45 mm (tangential direction) x 25 mm (radial direction). The lamellas were heat-treated at four different temperatures which were 170 °C, 190 °C, 210 °C and 230 °C. Control specimens were not exposed to heat-treatment. The lamellas were first heated to 100 °C, the creation of a vacuum taking 30 min at this temperature, and then heated to the desired temperature, and treated at this constant temperature for 3 h. The lamellas were then cooled down by using coils with cold water inside the chamber. Surface densification of lamellas with compression from 22 mm to 15 mm thickness was made by press platens heated at 150 °C and held in that position for 60 s. After the 1 min, the heated platen was cooled to 90 °C, whilst the specimen remained under compression to minimize immediate spring back. The total time of compression was 2 min (30 s closing, 60 s pressing and approx. 30 s cooling). In the treatment groups, the optimum treatment temperature on the one-side densified wood specimens was found to be 170 °C based on the surface roughness and wettability values. Surface densification significantly decreased the surface roughness of the wood specimens. The surface quality of wood can be improved when the wood is exposed to the heat-treatment and then surface densification.

**Keywords:** heat-treatment, wood, surface roughness, wettability, densification

**SAŽETAK** • Cilj istraživanja bio je izmjeriti hrapavost i stupanj kvašenja površine pregrijane i površinski ugušćene smrekovine (*Picea abies* L. Karst.) kako bi se utvrdio utjecaj ugušćivanja i pregrijavanja na svojstva po-

<sup>1</sup> Authors is professor at Istanbul University-Cerrahpasa, Forestry Faculty, Department of Wood Mechanics and Technology, Istanbul, Turkey.

<sup>2</sup> Authors are assistant professor and associate professor at University of Ljubljana, Biotechnical Faculty, Department of Wood Science and Technology, Ljubljana, Slovenia. <sup>3</sup> Authors is professor at National Institute of Forest Science, Department of Forest Products, Seoul, Republic of Korea.

<sup>1</sup> Autor je profesor Istanbulskog sveučilišta-Cerrahpasa, Šumarski fakultet, Zavod za mehaniku drva i tehnologiju, Istanbul, Turska. <sup>2</sup> Autori su docent i izvanredni profesor Sveučilišta u Ljubljani, Biotehnički fakultet, Zavod za znanost o drvu i tehnologiju, Ljubljana, Slovenija. <sup>3</sup> Autor je profesor Nacionalnog instituta šumarske znanosti, Zavod za šumarske proizvode, Seul, Republika Koreja.

vršine drva. Proces pregrijavanja s početnim vakuumom proveden je u vakuumskoj komori na apsolutno suhim lamelama dimenzija 630 mm (uzdužni smjer)  $\times$  45 mm (tangenti smjer)  $\times$  25 mm (radijalni smjer). Lamelle su pregrijane na četiri različite temperature: 170 °C, 190 °C, 210 °C i 230 °C. Kontrolni uzorci nisu bili pregrijani. Lamelle su najprije zagrijane na 100 °C i pri toj je temperaturi za postizanje vakuuma bilo potrebno 30 min. Uzorci su nakon toga zagrijani na željenu temperaturu koja je konstantno održavana tri sata. Potom su lamelle ohlađene uz pomoć hladne vode koja se nalazila u spiralnim cijevima unutar komore. Ugušćivanje površine lamela s 22 mm na 15 mm debljine provedeno je prešanjem zagrijanim pločama na temperaturi 150 °C u trajanju 60 s. Nakon jedne minute zagrijana je ploča ohlađena na 90 °C, dok je uzorak ostao pod pritiskom kako bi se umanjio trenutačni povrat. Ukupno vrijeme prešanja iznosilo je 2 min (30 s zatvaranje, 60 s prešanje i oko 30 s hlađenje). Na temelju vrijednosti hrapavosti i stupnja kvašenja utvrđeno je da je optimalna temperatura za jednostrano ugušćivanje ploče 170 °C. Ugušćivanjem površine znatno se smanjila hrapavost površine uzoraka drva. Zaključeno je da se kvaliteta površine drva može poboljšati pregrijavanjem i ugušćivanjem površine.

**Ključne riječi:** pregrijavanje, drvo, hrapavost površine, stupanj kvašenja, ugušćivanje

## 1 INTRODUCTION

### 1. UVOD

Heat-treatment is one of the most environmentally friendly methods to improve decay resistance and dimension stabilization of wood (Hill, 2006; Sinković *et al.*, 2011; Govorčin *et al.*, 2011). Heat-treatment is an effective method to improve some properties of wood such as biological durability and dimensional stability in changing environments. Heat-treatment changes the chemical composition of wood, which mainly results in the degradation of the hemicelluloses, carbohydrate cleavage, reduction in the degree of polymerization of the carbohydrates (Tjeerdsma *et al.*, 1998; Kariz *et al.*, 2017; Lunguleasa *et al.*, 2018).

Densification of wood is an effective way for modifying low density tree species to make them comparable with higher density tree species. Furthermore, densification is a way of utilizing low-density wood species instead of high density species in applications of higher value (Kariz *et al.*, 2017). The mechanical properties and dimensional stability of low-density wood can be improved by the heat-treatment in modification chamber followed by densification process (Kwon *et al.*, 2014). This will give a significant advantage to the densified wood for structural applications, which require stiffness, hardness, strength in building industry. Furthermore, heat-treatment and surface densification can open new markets for the lumber companies that use low density tree species such as pine, spruce, and fir.

Surface roughness and wettability are two important parameters that affect the surface quality of wood, in particular for paint and varnish, glue applications or use as floorings. There are different techniques to measure surface roughness of wood such as laser, acoustic emission, pneumatic, and stylus. The stylus technique is commonly used to quantify surface roughness of wood and wood-based composites. In the stylus technique, standard numerical parameter, such as average roughness ( $R_a$ ) and the maximum height of profile, is the sum of the largest peak height and the largest valley depth within a sampling length ( $R_z$ ), and the root mean square deviation of the profile ( $R_q$ ) is used to evaluate surface roughness of the material (ISO 4287:1997/Amd.1, 2009).

This study was a progressive part of the joint research work between University of Ljubljana Biotech-

nical Faculty and Forestry Faculty of Istanbul University. The aim of this study was to understand the effect of heat-treatment and then surface densification process on the surface properties of Norway spruce wood.

## 2 MATERIALS AND METHODS

### 2. MATERIJALI I METODE

#### 2.1 Heat-treatment of wood specimens

##### 2.1. Pregrijavanje uzoraka drva

Norway spruce (*Picea abies* L. Karst) wood lamellae with dimensions of 630 mm (longitudinal direction)  $\times$  45 mm (tangential direction)  $\times$  25 mm (radial direction) were heat-treated at increasing temperatures (170, 190, 210 or 230 °C) with the process having initial vacuum phase. The treatment process started with heating the lamellae to 100 °C and stabilization at this temperature, followed by a vacuum phase, when air was removed from the modification chamber. The chamber was then heated to the desired modification temperature (170, 190, 210 or 230 °C) and wood was treated at this temperature for 3 h and finally cooled to room temperature. Prior to surface densification, the conditioned lamellas were cut into specimens having dimensions of 150 mm (longitudinal direction), 43 mm (tangential direction) and thickness of 22 mm (radial direction). Ten specimens were used for each treatment type.

#### 2.2 Densification of wood specimens

##### 2.2. Ugušćivanje uzoraka drva

The one-side surface of the heat-treated wood specimens was densified using a specially designed hot-press fitted to a universal testing machine (Model: Zwick 1475). The specimens with the initial thickness of 22 mm were compressed in the radial direction (tangential surface) to the target thickness of 15 mm. The press platens consisted of upper unheated platen and bottom heated/cooled platen. The press platen was heated with electric heater inside the metal platen and cooled with cold water flow through the platen. Each specimen was attached to the unheated press platen. The press was then closed to the target thickness of 15 mm. The specimens were pressed on the platen heated at 150 °C and held in that position for 60 s. After the 1 min, the heated platen was cooled to 90 °C, whilst the specimen remained under compression to minimize immediate springback. The total time of compression

**Table 1** Density, weight loss, and equilibrium moisture content of heat-treated wood specimens at different temperatures (Kariz et al., 2017)

**Tablica 1.** Gustoća, gubitak mase i ravnotežni sadržaj vode pregrianih uzoraka drva pri različitim temperaturama (Kariz et al., 2017.)

Temperature, °C Temperatura, °C	Average density, kg/m <sup>3</sup> Srednja gustoća, kg/m <sup>3</sup>	Weight loss, % Gubitak mase, %	Equilibrium moisture content (EMC), % Ravnotežni sadržaj vode (EMC), %
Untreated control group Netretirani kontrolni uzorci	436 (35)	-	10.9 (0.4)
170	424 (12)	1.37 (0.08)	7.7 (0.4)
190	412 (20)	2.59 (0.18)	7.3 (0.4)
210	417 (17)	4.79 (0.34)	6.0 (0.3)
230	390 (19)	9.67 (0.85)	4.8 (0.5)

\*The values in the parenthesis are standard deviations. / Vrijednosti u zagradama standardne su devijacije.

was 2 min (30 s closing, 60 s pressing and approx. 30 s cooling). The densification of wood occurred only on the side in contact with the heated platen (Figure 1). The surface roughness and wettability measurements were performed on the surface exposed to the hot platen during the densification. Before the experiments, the treated lamellae were conditioned in a climate room with relative humidity of 65 % and temperature of 20 °C until a constant mass.



**Figure 1** Undensified control specimen and heat-treated/densified specimens

**Slika 1.** Kontrolni neugušćeni uzorci i pregriani/ugušćeni uzorci

### 2.3 Determination of surface roughness of wood specimens

#### 2.3. Određivanje hrapavosti površine uzoraka drva

The stylus method was used to measure the surface roughness of the control and treated wood specimens. Ten specimens were used for each treatment temperature and densification level. A total of forty measurements with a 15 mm tracing length, 2 measurements parallel and 2 measurements perpendicular to the fibers of each wood specimen (10 specimens for each treatment group and control group) were taken using a stylus profilometer (Mitutoyo SJ-301, Japan). Three surface roughness parameters ( $R_a$ ,  $R_z$ ,  $R_q$ ), specified in ISO 4287:1997/Amd.1:2009 standard, were used to evaluate the surface characteristics of the specimens. The average values and standard deviations of three roughness parameters were calculated for each treatment group. The tracing line ( $L_t$ ) and the cut-off were 15 mm and  $\lambda=2.5$  mm, respectively.

### 2.4 Determination of wettability of wood specimens

#### 2.4. Određivanje stupnja kvašenja uzoraka drva

The wettability of the specimens was determined by contact angle technique. The contact angle technique reveals significant findings to understand the surface absorption and coating properties of wood and wood-based composites (Kajita and Skaar, 1992). As the contact angle value of the water droplet is lower than 90°, the solid surface has hydrophilic property and, when the contact angle is higher than 90°, the solid surface has hydrophobic property. A distilled water droplet (5- $\mu$ L) was applied to the wood surface using a plastic pipette. The contact angle was then measured by a digital camera KSV CAM 101 (KSV

**Table 2** Densities of top and bottom surfaces of heat-treated and then densified spruce wood specimens (Kariz et al., 2017)

**Tablica 2.** Gustoće gornje i donje strane površine pregrianih i ugušćenih uzoraka smrekovine (Kariz et al., 2017.)

Heat-treatment temperature, °C Temperatura pregrijavanja, °C	Density of surface (hot platen side), kg/m <sup>3</sup> Gustoća površine (vruća strana ploče), kg/m <sup>3</sup>	Density of surface (cold platen side), kg/m <sup>3</sup> Gustoća površine (hladna strana ploče), kg/m <sup>3</sup>
170	737 (61)	405 (75)
190	624 (66)	469 (62)
210	608 (76)	458 (123)
230	578 (70)	393 (47)

\*The values in the parenthesis are standard deviations. / Vrijednosti u zagradama standardne su devijacije.



Instruments Ltd., Finland). The contact angles were recorded from 1 s time intervals up to a total of 30 sec. Ten specimens were used in the contact angle measurements. A total of 100 measurements, 2 measurements for each specimen, were taken from the equipment.

### 3 RESULTS AND DISCUSSION

#### 3. REZULTATI I RASPRAVA

The surface roughness parameters obtained from the specimens are presented in Figure 2. The untreated control group had the highest surface roughness, while the lowest surface roughness was found in the specimens treated at the highest temperature (230 °C). The average roughness ( $R_a$ ) parallel to the fiber direction of the wood was found to be 4.12  $\mu\text{m}$  for the untreated control wood, while it was determined as 2.02  $\mu\text{m}$  for the wood treated at 230 °C (Figure 2a). Similar results were found in the  $R_z$

and  $R_q$  values. The surface roughness values parallel to the fiber direction of the wood were found to lower than the roughness values perpendicular to the fiber direction (Figure 2b). The results showed that the heat-treatment and then surface densification greatly improved the surface roughness of wood specimens. The improvement in the surface smoothness of heat-treated spruce wood can also be related to this additional surface densification on the face of the wood. The surface densified wood specimens showed a glossy and smooth appearance after surface densification. Heat-treatment in the vacuum dryer, followed by densification in the hot press, tends to soften the wood fibers close to the surface layers and also plays a part in wood surface compaction and plasticization, which improves the surface smoothness as compared to undensified control wood (Ayrilmis and Winandy, 2009). The severity of the thermal degradation was directly related to the extent of the darkening of the wood color as

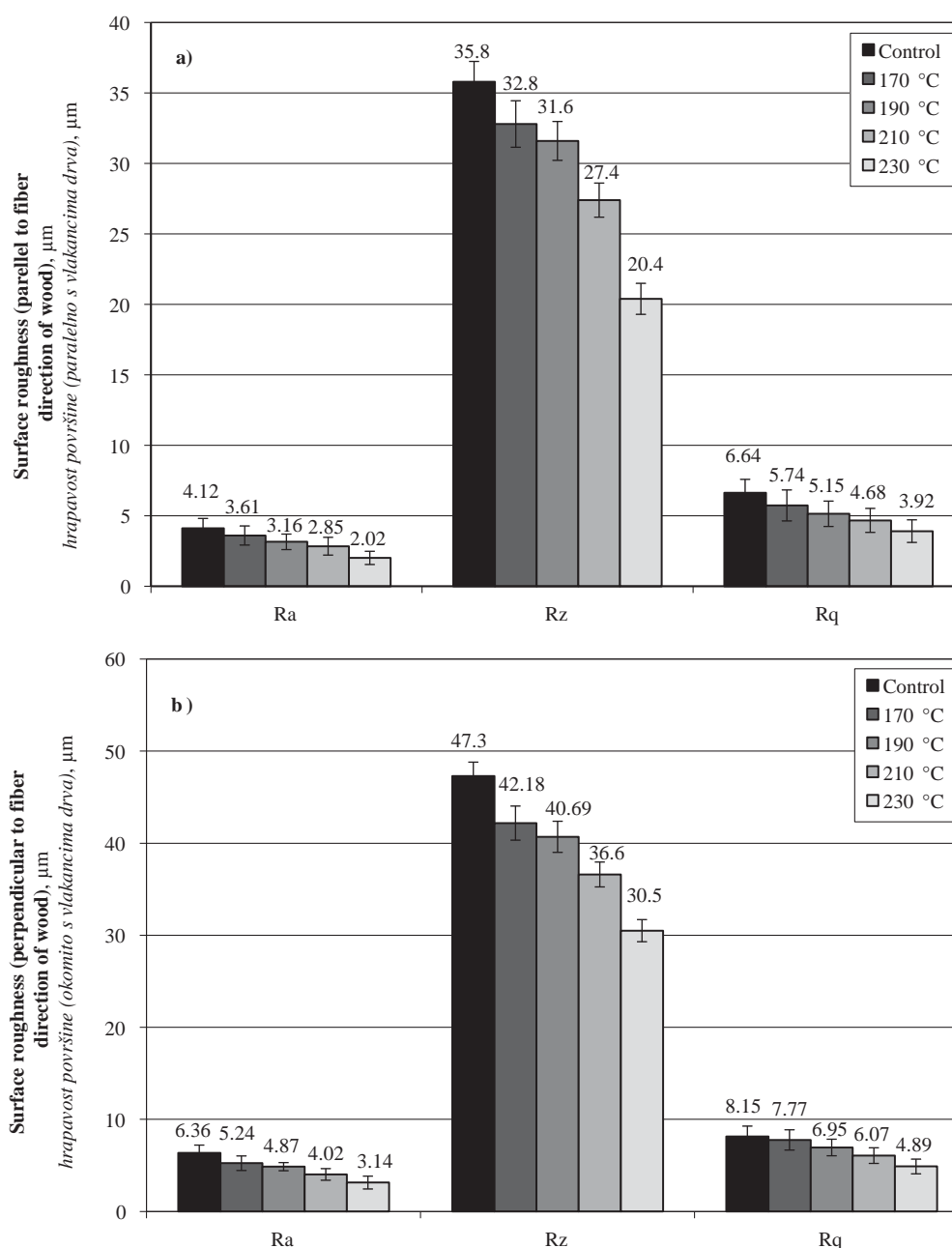

**Figure 2** Surface roughness of spruce wood specimens: a) parallel to the fiber direction, b) perpendicular to the fiber direction  
**Slika 2.** Hrapavost površine uzorka smrekovine: a) paralelno s vlakancima drva, b) okomito na vlakanca drva

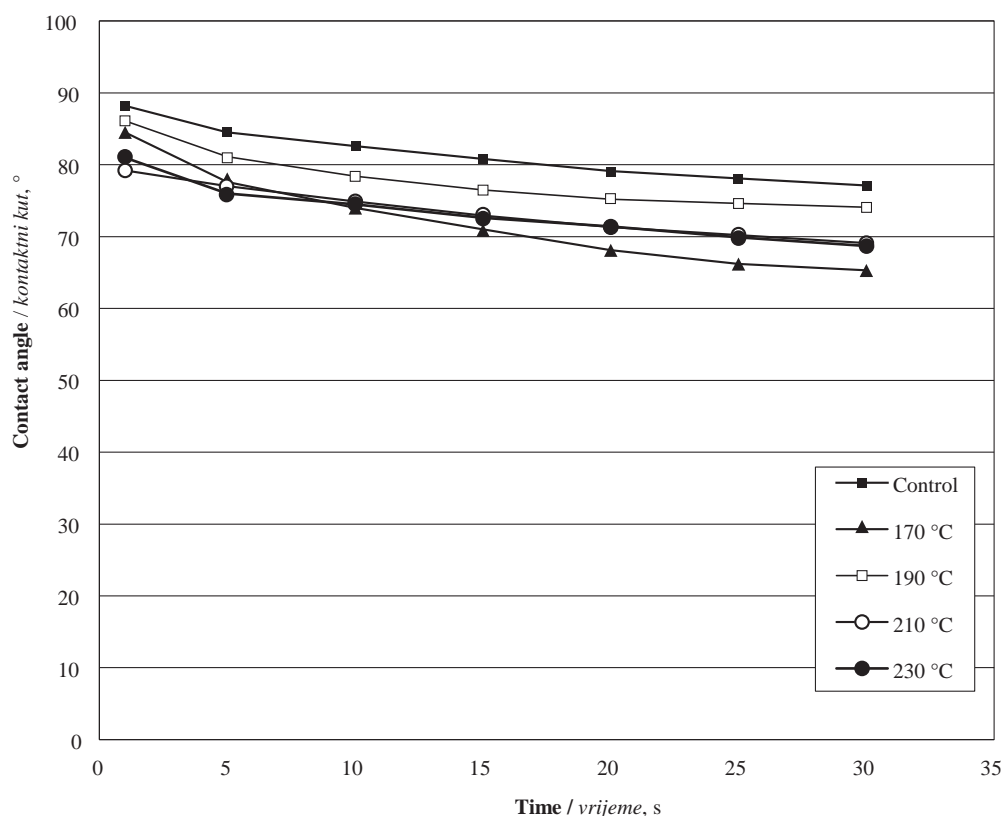

**Figure 3** Contact angle values of untreated and treated wood specimens  
**Slika 3.** Vrijednosti kontaktnog kuta netretiranih i tretiranih uzoraka drva

shown in Figure 1. Heat-treated wood specimens had lower equilibrium moisture content than untreated wood control group (Table 1).

During heat-treatment, physical and chemical changes occur in layers close to the surface, which results in a modified surface with new characteristics. At the glass transition temperature (160 °C), plastification of lignin starts affecting particularly the hydrophilic properties of wood (Hakkou *et al.*, 2005a; Petrissans *et al.*, 2003). Previous studies reported that surface roughness of heat-treated wood decreased with increasing treatment temperature and time (Unsal and Ayırlım, 2005; Korkut and Akgul, 2007; Korkut and Guller, 2008). Better surface smoothness of heat-treated wood could also be explained by the surface densification application. Surface densification reduces the porosity of wood and makes a glossy surface, which decreases the roughness of wood surface (Bekhta and Krystofiak, 2016).

The wettability behavior of the specimens is presented in Figure 3. The highest contact angle value at 1 s was found in the untreated control specimens, while the lowest contact angle was found in the specimens treated at 210 °C and then exposed to densification. However, as the measurement time was increased to 30 s, the lowest contact angle was found in the specimens treated at 170 °C.

The average contact angles of untreated control group and specimens treated at different time intervals are presented in Figure 3. It can be seen from Figure 3 that the contact angle values of the control group were higher than those of the treated groups.

Although the wettability of the specimens was measured with pure water, it provided information on

the spread of the coatings or adhesives on the wood surface. The surface coatings need to wet, flow or penetrate into the cellular structure of wood to make a good bond between the wood and coatings. The results showed that the wettability of the specimens generally increased with increasing the treatment temperature. The pressure applied to the one-side of the specimens in the hot press had also significant effect on the wettability of the specimens. The results showed that the heat-treatment and surface densification enhanced the wettability of spruce wood. In general, the trend was that the contact angles of the water droplet decreased with increasing heat-treatment temperature, except for the 170 °C. Although some previous studies reported that the densification of wood increase the contact angle value of wood (Kutnar *et al.*, 2012; Krystofiak *et al.*, 2014; Bekhta and Krystofiak, 2016), namely lower wettability, in our research an improvement in the wettability was observed. This can be explained by the lower surface roughness of the specimens. In addition, densified surface can be another reason for the lower contact values due to its glossy surface and plastification.

All the untreated control groups and treated specimens had a lower contact angle than 90°, which showed good wettability. Previous studies reported that the surface of heat-treated wood is less polar and thus repels water, resulting in a lower wettability than in the case of untreated wood (control group) (Petrissans *et al.*, 2003). Previous studies reported that wood surface becomes hydrophobic after heat-treatment, which results in a higher contact angle value than that of untreated wood (Hakkou *et al.*, 2005a; Hakkou *et al.*, 2005b). A similar

result was found in this study. In the present study, the contact angle values of the surface-modified specimens were found to be higher than those of control specimens (Figure 3). For example, the contact angle value of the control wood at 10 s was 82.6°, while it was found to be 74.5° for the densified wood treated at 230 °C.

## 4 CONCLUSIONS

### 4. ZAKLJUČAK

This study showed that the surface smoothness and wettability of Norway wood considerably improved with increasing heat treatment temperature. The untreated control group had the highest surface roughness and the lowest wettability. In the treatment groups, the optimum treatment temperature on the one-side densified wood specimens was found to be 170 °C based on the surface roughness and wettability values. Surface densification also greatly decreased the surface roughness of the wood specimens. The surface densified wood specimens showed a glossy and smooth appearance as well as darkening in the color depending on the severity of heat-treatment. The surface quality of low quality wood can be improved by heat treatment followed by surface densification. Apart from traditional heat-treatment process, the application of surface densification to the heat-treated Norway spruce wood improves the surface quality of wood, which is important for liquid and powder coating applications. The surface densification process after the heat treatment may be considered to replace more expensive hardwoods for outdoor applications such as flooring, siding, decking, and wall cladding.

### Acknowledgements – Zahvala

The authors would like to thank Slovenian Research Agency (P4-0015) for financial support.

The authors would also like to thank Jure Žigon for his technical contribution. This study was also supported by Research Fund of Istanbul University-Cerrahpasa. Project number: BYP-2018-31298.

## 5 REFERENCES

### 5. LITERATURA

1. Ayrilmis, N.; Winandy, J. E., 2009: Effects of post heat-treatment on surface characteristics and adhesive bonding performance of medium density fiberboard. *Materials and Manufacturing Processes*, 24: 594-599. <https://doi.org/10.1080/10426910902748032>.
2. Bekhta, P.; Krystofiak, T., 2016: The influence of short-term thermo-mechanical densification on the surface wettability of wood veneers. *Maderas Ciencia y Tecnología*, 18 (1): 79-90. <http://dx.doi.org/10.4067/S0718-221X2016005000008>.
3. Govorčin, S.; Sinković, T.; Hrčka, R., 2009: Some physical and mechanical properties of recent and heat treated ash – *Fraxinus excelsior* L. *Drvena industrija*, 133: 185-191.
4. Hakkou, M.; Petrissans, M.; Zoulalian, A.; Gerardin, P., 2005a: Investigation of wood wettability changes during heat-treatment on the basis of chemical analysis. *Polymer Degradation and Stability*, 89: 1-5. <https://doi.org/10.1016/j.polymdegradstab.2004.10.017>.
5. Hakkou, M.; Petrissans, M.; El Bakali, I.; Gerardin, P.; Zoulalian, A., 2005b: Wettability changes and mass loss

- during heat-treatment of wood. *Holzforschung*, 59: 35-37. <https://doi.org/10.1515/HF.2005.006>.
6. Hill, C. A. S., 2006: *Wood Modification: Chemical, Thermal and Other Processes*. John Wiley & Sons, Ltd., Bonger.
7. Kajita, H.; Skaar, C., 1992: Wettability of the surfaces of some American softwoods species. *Mokuzai Gakkaishi*, 38: 516-521.
8. Kariz, M.; Kuzman, M. K.; Sernek, M.; Hughes, M.; Rautkari, L.; Kamke, F. A.; Kutnar, A., 2017: Influence of temperature of thermal treatment on surface densification of spruce. *European Journal of Wood and Wood Products*, 75: 113-123. <https://doi.org/10.1007/s00107-016-1052-z>.
9. Korkut, S.; Akgul, M., 2007: Effect of drying temperature on surface roughness of oak (*Quercus petraea* ssp. *iberica* (Steven ex Bieb) Krassiln) Veneer. *Building and Environment*, 42: 1931-1935. <https://doi.org/10.1016/j.buildenv.2006.04.010>.
10. Korkut, D. S.; Guller, B., 2008: The effects of heat-treatment on physical properties and surface roughness of red-bud maple (*Acer trautvetteri* Medw.) wood. *Biore-source Technology*, 99: 2846-2851. <https://doi.org/10.1016/j.biortech.2007.06.043>.
11. Krystofiak, T.; Bekhta, P.; Muszyńska, M., 2014: Effect of temperature of thermo-mechanical treatment of pine wood (*Pinus sylvestris* L.) veneers upon gloss and wettability. *Annals of Warsaw University of Life Sciences – SGGW Forestry and Wood Technology*, 88: 126-129.
12. Kutnar, A.; Laine, K.; Hughes, M., 2012: Thermodynamic characteristics of surface densified solid Scots pine wood. *Holz als Roh und Werkstoff*, 70: 727-734. <https://doi.org/10.1007/s00107-012-0609-8>.
13. Kwon, J. H.; Shin, R. H.; Ayrilmis, N.; Han, T. H., 2014: Properties of solid wood and laminated wood lumber manufactured by cold pressing and heat treatment. *Materials and Design*, 62: 375-381. <https://doi.org/10.1016/j.matdes.2014.05.032>.
14. Lunguleasa, A.; Ayrilmis, N.; Spirchez, C.; Özdemir, F., 2018: Investigation of the effects of heat treatment applied to beech plywood. *Drvena industrija*, 69: 349-355. <https://doi.org/10.5552/drind.2018.1768>.
15. Petrissans, M.; Gerardin, P.; Elbakali, D.; Serraj, M., 2003: Wettability of heat-treated wood. *Holzforschung*, 57: 301-307. <https://doi.org/10.1515/HF.2003.045>.
16. Sinković, T.; Govorčin, S.; Sedlar, T., 2011: Comparison of physical properties of untreated and heat treated beech and hornbeam. *Drvena industrija*, 62: 283-290. <https://doi.org/10.5552/drind.2011.1118>.
17. Tjeerdsma, B. F.; Boonstra, M.; Militz, H., 1998: Thermal modification of nondurable wood species. Part 2. Improved wood properties of thermally treated wood. *International Research Group on Wood Preservation, IRG/WP 98-40124*, p 12.
18. Unsal, O.; Ayrilmis, N., 2005: Variations in compression strength and surface roughness of heat-treated Turkish river red gum (*Eucalyptus camaldulensis*) wood. *Journal of Wood Science*, 51: 405-409. <https://doi.org/10.1007/s10086-004-0655-x>.
19. \*\*\*ISO 4287, 1997 + Amd.1, 2009: Geometrical product specifications (GPS). Surface texture. Profile method. Terms. Definitions and surface texture parameters.

### Corresponding address:

Assoc. Prof. MANJA KITEK KUZMAN, PhD  
University of Ljubljana  
Biotechnical Faculty  
Department of Wood Science and Technology  
Jamnikarjeva 101, SI-1000 Ljubljana, SLOVENIA  
e-mail: manja.kuzman@bf.uni-lj.si

# The Effect of Using Alum Mordant in Wild Cherry Bark Dyestuff for the Production of UV Resistant Colored Paper

## Utjecaj aluminijskog fiksatora u bojilu od kore divlje trešnje na proizvodnju obojenog papira otpornoga na UV svjetlost

### Original scientific paper • Izvorni znanstveni rad

Received – prispjelo: 12. 12. 2018.

Accepted – prihvaćeno: 20. 11. 2019.

UDK: 630\*814.111; 630\*862.32; 630\*892.4

<https://doi.org/10.5552/drvind.2019.1854>

**ABSTRACT** • Depending on the use of wood in the forest industry, wood bark is mostly peeled and used as fuel. The ash and smoke left from the burned bark causes environmental pollution. The most environmentally friendly method for waste disposal is to convert waste into a valuable commodity. In this study, cherry tree bark was used as a dyestuff in paper production. Wild cherry (*Cerasus avium* L.) bark was boiled with water and KOH. The purpose of using KOH is to increase the solubility of the bark compounds. The chemi-thermomechanical pulp (CTMP) was dyed using the dyestuff. The alum mordant is used to fix the dyestuff. Paper can be exposed to external influences (mechanical, physical and biological) depending on the place of use. One of these effects is sunshine. When paper is exposed to direct or indirect sunlight, paper changes its color. Depending on the place of use, it is expected that the color of the paper will not be affected by the sunlight or that it will provide long-term strength after the application. Accelerated weathering test was chosen to measure the UV resistance of the dyestuff. The results have shown that the mordant has a significant effect on the fixation of dyestuff. After a total of 150 hours of weathering test, the color change was observed to be the lowest in the paper samples to which alum mordant was added to the dyestuff.

**Keywords:** wild cherry bark, chemical-thermomechanical pulp (CTMP), alum, weathering

**SAŽETAK** • Ovisno o uporabi drva u drvnoj industriji, kora drva uglavnom se ljušti i služi kao gorivo. Pepeo i dim od spaljene kore onečišćuju okoliš. Najprikladnija ekološka metoda za zbrinjavanje otpada jest njegovo iskorištavanje u proizvodnji novih proizvoda. U ovom je istraživanju kora trešnjina drva upotrijebljena kao bojilo u proizvodnji papira. Kora divlje trešnje (*Cerasus avium* L.) kuhana je u smjesi vode i KOH. Zadaća KOH jest povećanje topljivosti spojeva u kori drva. Celuloza dobivena kemi-termomehaničkim postupkom (CTMP-om) obojena je uz pomoć bojila. Aluminijski fiksator upotrijebljen je za fiksiranje bojila. Papir može biti izložen vanjskim mehaničkim, fizičkim i biološkim utjecajima, ovisno o mjestu uporabe. Jedan o tih utjecaja je i Sunčeva svjetlost. Papir mijenja boju kada je izložen izravnoj i neizravnoj Sunčevoj svjetlosti. Pretpostavka je da o mjestu uporabe ovisi hoće li Sunčeva svjetlost utjecati na boju papira te hoće li papir zadržati čvrstoću tijekom dulje uporabe. Za mjerenje UV otpornosti bojila odabrano je njegovo ubrzano izlaganje vremenskim utjecajima. Prema rezultatima,

<sup>1</sup> Authors are researchers at Bartın University, Faculty of Forestry, Department of Forest Industry Engineering, Bartın, Turkey.

<sup>1</sup> Autori su istraživači Sveučilišta Bartın, Šumarski fakultet, Zavod za industriju u šumarstvu, Bartın, Turska.

utvrđeno je da fiksator ima znatan utjecaj na fiksiranje bojila. Nakon 150 sati izlaganja ustanovljena je najmanja promjena boje na uzorcima papira obojenim bojilom koje sadržava aluminijski fiksator.

**Ključne riječi:** kora divlje trešnje, celuloza dobivena kemi-termomehaničkim postupkom (CTMP-om), aluminiij, izlaganje vremenskim utjecajima

## 1 INTRODUCTION

### 1. UVOD

The bark is a cover that protects the tree trunk from external influences. Due to its low specific gravity, it plays an important role in the thermal insulation of the tree trunk and it constitutes an important part of the total body as biomass. In terms of anatomical and chemical properties, it has a very complex and different structure compared to wood. Some basic components do not show similarity to wood and therefore are not used as wood. In most application areas, the bark is stripped off before the wood is used. Studies on the industrial use of the bark are very limited. In fact, the bark is an important low-cost and abundantly available biomass. However, unsuitable fibers and some substances in its structure negatively affect its use. As a result, the use of the bark is problematic because it reduces the quality of wood-based products. For example, in fiberboard production, due to its cork-like structure, incomplete compression of the remaining bark in the fiber layer on the surface of the board, after hot-pressing, disrupts the smoothness of the surface by expanding (Suchsland and Woodson, 1986). In another study, it was stated that a small amount of bark, remaining in the pulp during paper production, caused fading and an unattractive appearance (Hale, 1969). In addition, when prunings from the kiwi (*Actinidia deliciosa*) plant were used in the production of paper pulp via the Kraft method, the color and mechanical properties of the paper were adversely affected by the bark (Gençer, 2015). Therefore, most wood is stripped of bark before production.

The amount of bark in plants varies according to species. Reddy and Yang (2009) determined the bark ratio as 20 % in the stems of the cotton plant. Kiwi (*Actinidia deliciosa*) has been reported to have a bark ratio of 22 % of dry wood weight (Gençer, 2015). When bark is considered as waste material, it represents a significant loss of biomass.

The bark, for which no significant industrial use can be found, is mostly burned after stripping to obtain energy. Although the combustion process is seen as a solution to energy production and to elimination of waste bark, the emissions into the atmosphere and some substances passing into the ash can be problematic in terms of gas and solid waste disposal (Stavropoulos, 1988). For this reason, waste should be converted into useful products rather than burned. This would result in decreasing environmental pollution with a positive impact on the ecological balance.

Paper is traditionally dyed to make it visually appealing. In addition, publishing and printing operations are equipped with dyeing capabilities. There are many methods for the production of natural dyestuffs obtained from organic materials. Ethanol extraction was used to obtain dyestuff from walnut husk for dyeing silk thread

(Mirjalili *et al.*, 2011). Dyestuff was obtained from leftover hazelnut waste (leaves, husks, shells and slash) via soaking in deionized water and a subsequent boiling process (Tutak and Benli, 2012). Feng *et al.* (2007) were successful in dyeing cotton and silk yarns using the roots of *Rheum* and *Lithospermum erythrorhizon* plants and reported in their study that they were able to produce UV-resistant clothing from the dyed yarn. In the paper and dyeing industries, the use of a mordant for color stability is common. Khan *et al.* (2016) used  $\text{Al}_2\text{K}_2(\text{SO}_4) \cdot 24\text{H}_2\text{O}$  as a mordant in the dyeing of wool yarn with walnut husk extract. Bechtold *et al.* (2007), using  $\text{Fe}_2\text{SO}_4 \cdot 7\text{H}_2\text{O}$  as a mordant, achieved the darkest color with a dyestuff obtained from the hot water extract of the ash-tree bark. They stated that they dyed 1 g of wool yarn with 1-2 g of dyestuff and that the increase of dyestuff ratio did not change the color tone. Gençer and Can (2016), in their study, obtained an organic dyestuff from the seeds of the elderberry plant (*Sambucus nigra* L.). They reported that upon dyeing paper, the use of alum as a mordant increased the color fastness. For these reasons, it is necessary to use an appropriate mordant in paper dyeing. Wild cherries grow naturally in Turkish forests. The wood has an appearance that is particularly preferred in the veneer, furniture and parquet industries. In one study, it is stated that the fibers fall within the averages of hardwood fibers and are suitable for the production of paper pulp using the Kraft method (Gençer and Gül Türkmen, 2016). In all of these applications, the bark is stripped and left unused.

The aim of this study was to dye paper by dyestuffs obtained from the wild cherry bark, which is used as fuel or left as waste in the forest industry sector. Alum ( $\text{Al}_2\text{SO}_4 \cdot 18\text{H}_2\text{O}$ ) was used as a mordant in order to examine the effect of the retention and fastness of the dyestuff. In the study, KOH was used to dissolve the tannin substances in the bark and to increase the soluble dye ratio. Although NaOH is generally used in solubility experiments, Na ions create saline waste water, which cannot be released in streams, lakes and seas without treatment (Zou *et al.*, 2000). However, potassium is an important nutrient source for plants if used correctly. Gençer *et al.* (2006) reported that the black alkaline solution of  $\text{H}_2\text{SO}_4$  and  $\text{P}_2\text{O}_5$  left behind from paper pulp production using KOH and wheat stalks was applied as fertilizer after neutralization. Here KOH was chosen because it is less polluting.

## 2 MATERIALS AND METHODS

### 2. MATERIJALI I METODE

The bark stripped from wild cherry (*Cerasus avium* L.) wood was cut into 2 cm<sup>2</sup> samples and left to air dry without exposure to direct sunlight. These samples were then kept in closed polyethylene bags for 24 h to ensure that the moisture was balanced. At the end

of this period, the damp bark samples were held in a drying oven for 24 h and the full dry bark weight was calculated. The full dry weight of the bark was calculated as 19 % compared to the cherry wood. Due to structural differences of the bark and varying levels of the components, there is no standard method for bark analysis. In research studies to date, analysis has been carried out by alkali extraction or acid hydrolysis of extracted bark samples using nonpolar organic solvents and polar solvents. In producing the dyestuff, three different groups of dye were obtained from the cherry wood bark. To this purpose, 100 g of full dry weight bark was added to water only (Group I), to 1 % KOH + water (Group II) and to 2 % KOH + water (Group III), and each was boiled for 4 h. The experimental colored papers were attained by adding the cooled and strained dyestuff to the fiber suspension.

The pulp used in the paper production consisted of bleached chemical-thermo-mechanical pulp. In order to fully understand the effect of the dyestuff, control papers were produced from this pulp and the gloss of the papers was determined. There are three basic methods for adding dyestuff to paper: (1) the Hollander, (2) the glue process, and (3) the calendar for surface coating (Casey, 1960). Before obtaining the control papers and the dyestuff-colored papers, the pulps were kept in water for 24 h and hydrated. In order to open the pellets, each of the fiber suspensions prepared after this time was subjected to 10 min mixing in a Hollander beater with no load.

Cellulose fibers are negatively charged. They are treated with positively charged mordants to increase the bond by attracting negative and uncharged dyes by loading a positive charge (Casey, 1960). In the experiments using the mordant, alum (1 % or 2 % based on oven-dried pulp) was first added to the Hollander with the loading of the fibers and mixed for 10 min to homogenize the suspension. Dyeing with the added alum ensured that the dye was distributed homogeneously when the dyestuff was added to the working Hollander. According to ISO 5269-2 (2013) standard, (70±2) g/m<sup>2</sup> grammage from the pulps of each sample group was used to produce six trial paper sheets using the Rapi-

tan-Köthen sheet former. The opacity values of these papers were determined according to the TAPPI T519 om-02 (2002) standard.

Table 1 shows the conditions for obtaining the dyestuff groups and the addition rates of alum to the papers.

Accelerated weathering testing was performed as per ASTM G53 (1988) using Q-Panel Lab Products equipment. The test medium was applied with 340 nm lamps set at 50 °C. The UV light was applied at a light intensity of 0.85 W/m<sup>2</sup> for 24 h. The color and opacity values of the samples were measured at time intervals of 10 h, 25 h, 50 h, 100 h and 150 h for a total of 150 h. Three measurements were performed on each sample and then averaged. Using the Konica Minolta CD-600 color-measuring device, color measurement analyses were made on the test samples before and after the natural outdoor and accelerated outdoor environment testing in accordance with ISO 7724-2 (1984) standards. Color measurements were taken from three different points of the prepared samples and the average was used. Three samples were used for each variation.

The CIEL\*a\*b\* (Commission Internationale de l'Eclairage) system consists of three variables (ISO 7724-2, 1984): L\* (light stability), a\* (red/green) and b\* (yellow/blue). The chromatographic coordinates include +a\* for red, -a\* for green, +b\* for yellow and -b\* for blue. The L\*, a\* and b\* values were determined in the samples and the color changes were calculated according to the following Eqs. 1-4:

$$\Delta L^* = L_f^* - L_i^* \quad (1)$$

$$\Delta a^* = a_f^* - a_i^* \quad (2)$$

$$\Delta b^* = b_f^* - b_i^* \quad (3)$$

$$\Delta E^* = (\Delta L^*{}^2 + \Delta a^*{}^2 + \Delta b^*{}^2)^{1/2} \quad (4)$$

Where  $\Delta L^*$ ,  $\Delta a^*$  and  $\Delta b^*$  indicate the color changes ( $\Delta E^*$ ) that occur at the beginning (i) and at different time intervals (f). Low  $\Delta E^*$  indicates color change or color stability.

Gloss measurements were made by using the light reflection capabilities of the test samples. Typically, there were no different results in the measurements of the surfaces with the same gloss characteristics. Generally, on glossy surfaces, surface gloss values are obtained by multiple measurements. Gloss measurements were taken using a gloss meter device at 60°.

The results of the weathering test were analyzed by one-way variance analysis (ANOVA) using the SPSS 16.0 program. The significance level ( $P < 0.05$ ) between the variations was compared using Duncan homogeneity groups in which different letters, given along with the average values of the tested parameters, indicated a significant difference.

### 3 RESULTS AND DISCUSSION 3. REZULTATI I RASPRAVA

The color of the paper after dyeing with dyestuffs is expected to exhibit a fastness to light, stability to wa-

**Table 1** Dyestuff group conditions and percent of alum added to paper groups

**Tablica 1.** Skupine papira i bojila te postotni udio aluminijskog fiksatora

Paper groups <i>Skupine papira</i>	Dyestuff groups <i>Skupine bojila</i>	KOH	Alum <i>Aluminijski fiksator</i>
1	-	-	-
2	I	-	-
3		-	1 %
4		-	2 %
5		1 %	-
6	II	1 %	1 %
7		1 %	2 %
8		2 %	-
9	III	2 %	1 %
10		2 %	2 %

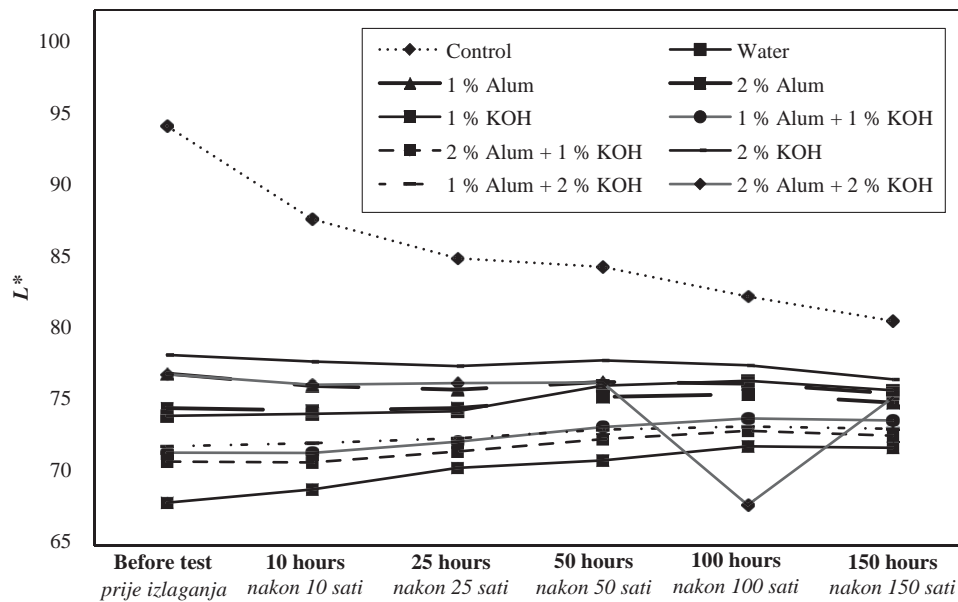
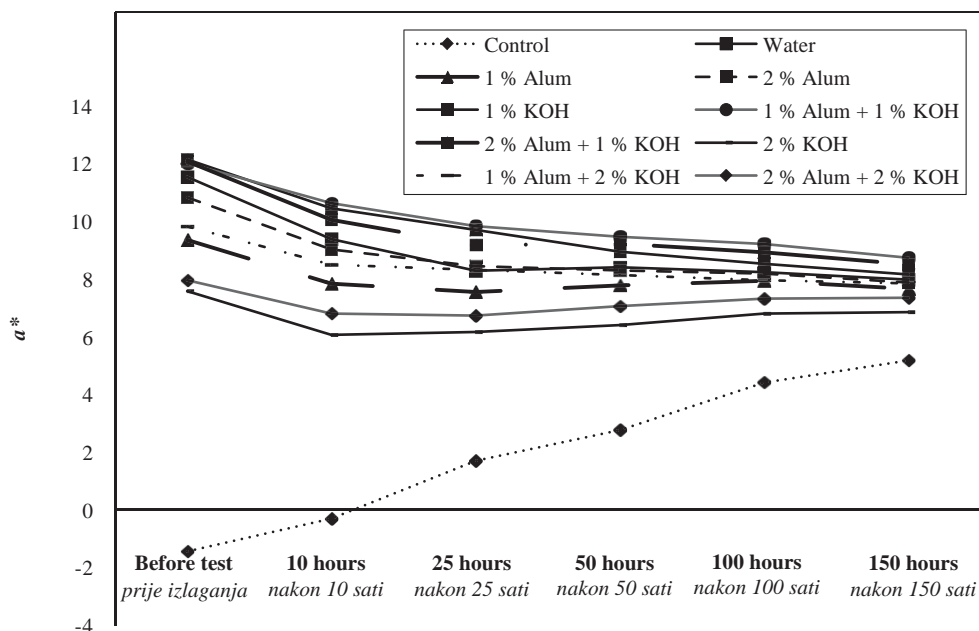

**Figure 1** Light values ( $L^*$ ) of paper samples before and after weathering  
**Slika 1.** Svjetlina ( $L^*$ ) uzoraka papira prije i nakon izlaganja vremenskim utjecajima

ter solubility, fastness to acid and alkali, and fastness to chlorine (Casey, 1960). In our study, light fastness was examined. The  $L^*$  (light intensity) values determined in the test and control samples were calculated using the  $a^*$  and  $b^*$  chromatographic coordinates ( $+a^*$  red,  $-a^*$  green,  $+b^*$  yellow and  $-b^*$  blue) in the CIEL\* $a^*b^*$  system. The calculated 10, 25, 50, 100, 150 h accelerated aging values of  $L^*$ ,  $a^*$ ,  $b^*$  and total color change ( $\Delta E^*$ ) are shown in Figures 1-4. The graphs were created based on the color change after a total of 150 h.

The  $L^*$  (light intensity) tends towards white as it approaches 100 and towards black when approaching 0. The different ratios of alum added in the paper production to increase the color fastness and the KOH used in the boiling medium reduced the  $L^*$  value. However, the  $L^*$  values increased in these samples par-

allel to the increase in weathering time. The light intensity in the control sample was 94.37, while in the sample from cherry wood bark boiled in 1 % KOH, this ratio decreased to 68.01. Except for the 1 % KOH group, in other samples, the  $L^*$  values decreased in parallel with the increase in the aging process time. The maximum reduction was obtained in the control samples, whereas the test samples showed nearly no reduction. Similar findings have been found in a previous study in which the  $L^*$  values of the samples decreased with the effect of 72, 144, and 256 h of accelerated aging (Gençer *et al.*, 2016). This finding is the result of the presence of carbonyl groups formed in the paper by the aging process; these carbonyl groups subsequently reduce the whiteness of the paper (Hon, 1981; Konuklar, 2011).



**Figure 2** Red/green colors ( $a^*$ ) of paper samples before and after weathering  
**Slika 2.** Crvena/zelena komponenta boje ( $a^*$ ) uzoraka papira prije i nakon izlaganja vremenskim utjecajima

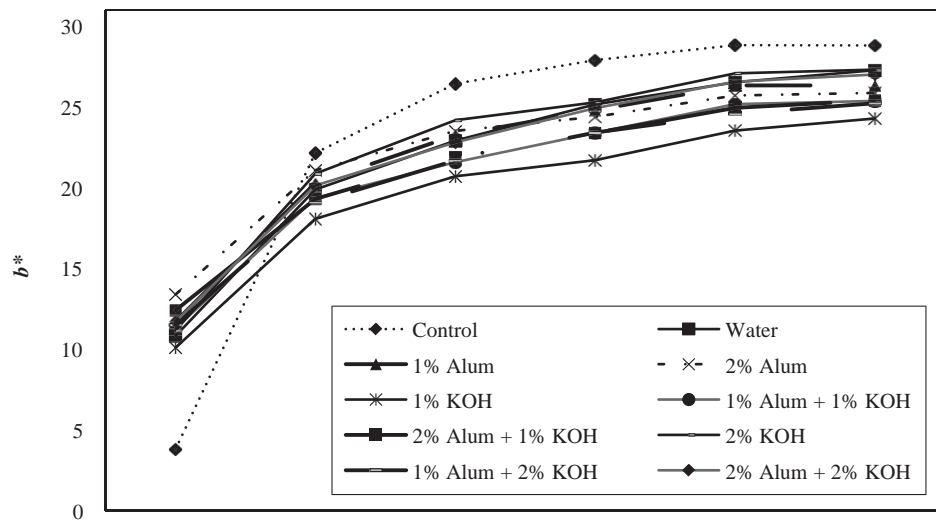

**Figure 3** Yellow/blue colors ( $b^*$ ) of paper samples before and after weathering  
**Slika 3.** Žuta/plava komponenta boje ( $b^*$ ) uzoraka papira prije i nakon izlaganja vremenskim utjecajima

When the  $a^*$  value of the red/green color is examined, the  $a^*$  value of -1.45 in the control samples varies between 7-12 with alum added and KOH used in the boiling medium during the paper production. The maximum value was obtained in the group with 1 % alum + 1 % KOH. As a result, the sample surfaces had a reddish color. Although the  $a^*$  value of the control samples increased with the increase of the aging process at different duration times, the  $a^*$  value of the test group samples decreased. The  $a^*$  value of the control samples increased to 5.17 with the effect of UV light, while the 2 % KOH group decreased to 7.34. In the case of UV aging for more than 150 h, it was thought that the test and control group samples would intersect at the same  $a^*$  value.

The increase in the  $b^*$  value indicated that the samples tended toward yellow. The  $+b^*$  value shows a tendency towards yellow, whereas the  $-b^*$  shows a tendency towards blue color. During the paper production,

the added alum and the KOH substances used in the boiling medium caused a slight yellowing in the color of the paper because the  $b^*$  value in the control samples of 3.82 increased to 12.40 in the test samples (Figure 3). With the aging process, the yellowing of the paper increased. After a period of 100 h, the  $b^*$  values, which tended to increase, became stable. Thus, maximum yellowing was obtained in the control samples (28.82) after 100 h.

Figure 4 shows the total color change values in the samples after 150 h of aging. At the end of 150 h, color changes were observed in 29.23 % of the control samples. In contrast, the total color change values of the samples produced with dyestuffs were significantly lower. In these sample groups, the total color change was reduced by 42 % compared to the control samples. There was a decrease in total color change with the increase in alum ratio. With the addition of 2 % alum, the total color change value dropped to 12.86. According

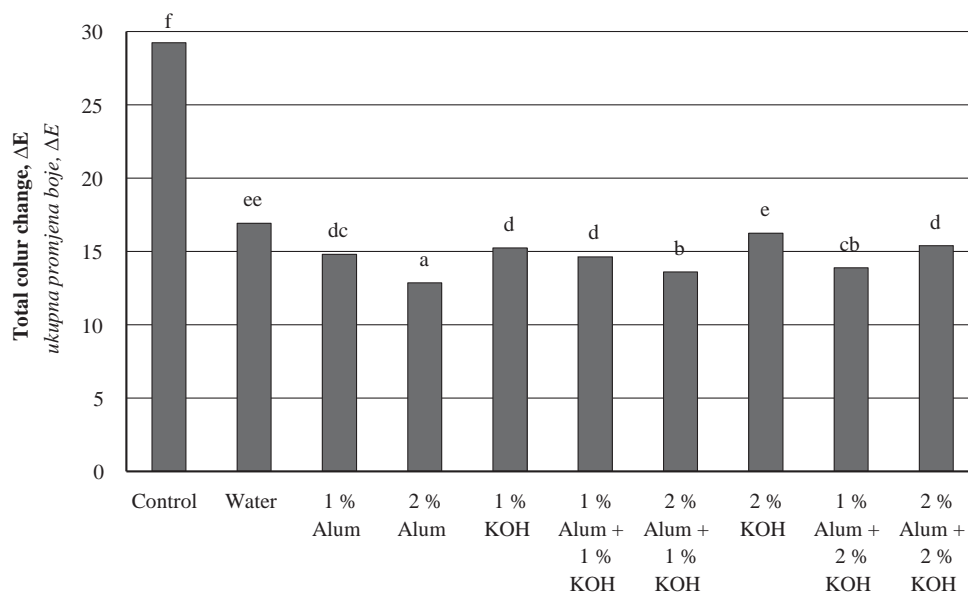

**Figure 4** Total color changes of paper samples after weathering  
**Slika 4.** Ukupna promjena boje uzoraka papira nakon izlaganja vremenskim utjecajima



**Table 2** Effect of aging on paper gloss change (60°)**Tablica 2.** Utjecaj starenja na promjenu sjaja papira (60°)

	Before test <i>Prije izlaganja</i>	10 hours <i>Nakon 10 sati</i>	25 hours <i>Nakon 25 sati</i>	50 hours <i>Nakon 50 sati</i>	100 hours <i>Nakon 100 sati</i>	150 hours <i>Nakon 150 sati</i>
Water	36.46 (0.05)dcb	12.50 (0.05)d	12.50 (0.05)d	18.30 (0.05) dcb	17.76 (0.05) cb	16.33 (0.10)cb
1 % Alum	31.77 (0.05)ed	5.88 (0.05)f	5.88 (0.05)f	15.03 (0.15)dc	14.47 (0.25)cb	13.61 (0.25)cb
2 % Alum	42.71 (0.05)ba	21.32 (0.05)b	21.32 (0.05)b	26.14 (0.15)ba	23.68 (0.15)ba	22.45 (0.10)ba
1 % KOH	36.98 (0.11)dcb	13.24 (0.11)d	12.24 (0.05)d	18.30 (0.05)dcb	16.45 (0.05)cb	14.29 (0.00)cb
1 % Alum + 1 % KOH	45.83 (0.05)a	25.74 (0.05)a	25.74 (0.05)a	31.37 (0.00)a	30.92 (0.01)a	28.57 (0.10)a
2 % Alum + 1 % KOH	40.63 (0.00)cba	18.38 (0.00)c	18.38 (0.05)c	23.53 (0.00)ba	22.37 (0.05)cba	20.41 (0.10)cba
2 % KOH	29.69 (0.00)e	2.94 (0.00)g	2.94 (0.05)g	12.42 (0.05)d	11.84 (0.05)c	10.88 (0.05)c
1 % Alum + 2 % KOH	34.38 (0.00)edc	9.56 (0.00)e	9.56 (0.05)e	17.65 (0.00)dcb	15.79 (0.05)cb	14.29 (0.00)cb
2 % Alum + 2 % KOH	29.17 (0.05)e	2.21 (0.05)g	2.21 (0.05)g	13.73 (0.01)dc	13.82 (0.05)cb	12.24 (0.10)cb

\* Values in parentheses: Standard deviation. / *Vrijednosti u zagradama standardna su devijacija.*

Letters in columns: Duncan test results. / *Slova u stupcima označavaju rezultate Duncanova testa.*

to statistical analysis results, with the use of 2 % alum, the total color change differed from the other groups. There was a slight increase in the total color change in the papers that were boiled in 1-2 % KOH medium and the values obtained were near to those of the papers produced by boiling in the water medium. Thus, the boiling medium had no significant effect on total color change. However, Ali *et al.* (2009), in their study on the effects of dyestuff from the henna plant obtained via alkaline and deionized water extraction, reported that the alkaline yielded a stronger color in the dyeing of cotton yarn. The carbonyl and carboxyl groups in the paper act on the color of the paper (Konuklar, 2011). Hence, the dyestuff of the dye material alone led to the modification of these bonds, resulting in a decrease in total color change.

Table 2 shows the change in gloss values of the test samples with the aging process as compared to the initial gloss values. Before the weathering test, the lowest gloss value was statistically calculated in the 1 % alum + 1 % KOH samples, while the highest gloss value was obtained in the control samples. The maximum change in gloss values was obtained in the control samples. The gloss values of the control samples decreased by 29.22 % in the first 10 h, and at the end of 150 h, there was a decrease of 23.44 % in gloss. Parallel to the increase in weathering time and the decrease of the gloss value of the control samples, with the weathering process, the color change in the lignin caused the gloss to decrease. The glossiness of test samples did not change significantly after 150 h. Generally, a similar situation was observed in all test samples. Alum and KOH substances are thought to increase the gloss of paper. In one study it was stated that, with the aging process, the control papers could not maintain the gloss values, while the test samples provided a certain gloss stability (Peşman,

2010). Table 3 shows the opacity values of paper samples before and after aging.

No significant change in opacity of control samples was observed in the first 10 h of aging. However, statistically, there were differences between the control and test samples. The opacity values of the paper decreased significantly with 25 h of the aging process, with the maximum reduction obtained in the 1 % KOH samples.

Although the opacity value of the control samples was 93.58 %, the opacity value of 96.94 % for the paper in Group I produced from dyestuff without mordant was increased to 98.22 % with the use of 1 % mordant and to 96.50 % with 2 % mordant. In Group II, the opacity decreased from 98.60 % to 98.12 % when 1 % mordant was used, but increased to 99.35 % when 2 % mordant was added. The opacity of the paper in Group III obtained from dyestuffs without mordant was 98.47 %, which increased to 99.07 % with the use of 1 % mordant, while decreasing to 97.95 % when 2 % mordant was used. However, these decreases were not statistically significant.

According to these results, the KOH added to obtain the dyestuff was not effective in the bonding of the dyestuff. Therefore, we believe that only water should be used in the dyeing process. Disintegration of the fibers along with the aging process and the yellowing of the paper were thought to reduce opacity values (Clark, 1978).

Statistical analysis revealed that opacity values differed from the control with the addition of 2 % alum and 1-2 % KOH. It was also observed that the first 10 h weathering process decreased the opacity by a statistically significant amount. However, after 25 h of weathering, the opacity values of the control samples increased. As for maintaining the opacity values of the samples after 150 h

**Table 3** Effect of aging on paper opacity

**Tablica 3.** Utjecaj starenja na neprozirnost papira

	Before test <i>Prije izlaganja</i>	10 hours <i>Nakon 10 sati</i>	25 hours <i>Nakon 25 sati</i>	50 hours <i>Nakon 50 sati</i>	100 hours <i>Nakon 100 sati</i>	150 hours <i>Nakon 150 sati</i>
Control	93.58 a* (0.36)	94.49 a (0.16)	84.00h (0.47)	100.00e (0.00)	99.52e (0.81)	96.68 a (0.98)
Water	96.94ba (6.54)	98.49 c (0.42)	64.56e (0.88)	95.17c (1.01)	93.41c (0.56)	96.95a (0.11)
1 % Alum	98.22 ba (4.03)	97.24b (0.90)	66.83f (0.35)	97.54d (0.12)	95.33d (0.37)	98.16cb (0.34)
2 % Alum	96.5 b (1.42)	98.98edc (0.88)	63.73d (0.31)	94.67c (0.18)	93.66c (0.20)	98.29cb (0.53)
1 % KOH	98.6 b (0.96)	99.90f (0.00)	56.51a (0.01)	82.68a (1.70)	84.04a (1.36)	99.33d (0.38)
1 % Alum + 1 % KOH	98.12 b (1.04)	99.77 fe (0.17)	60.49c (0.09)	87.37b (1.76)	86.55b (1.40)	99.48d (0.80)
2 % Alum + 1 % KOH	99.35 b (0.77)	99.61 fed (0.09)	58.82b (0.62)	87.35b (1.32)	87.77b (1.72)	99.69d (0.15)
2 % KOH	98.47 b (0.72)	98.41c (0.23)	70.37g (0.42)	100.00e (0.00)	99.09e (0.79)	97.99b (0.17)
1 % Alum + 2 % KOH	99.07b (0.12)	98.83 dc (0.42)	59.60b (0.55)	88.71b (0.12)	92.88c (0.29)	98.34dc (0.20)
2 % Alum + 2 % KOH	97.95b (0.05)	98.68 c (0.11)	67.60f (0.30)	98.05d (0.28)	99.98e (0.00)	98.35cb (0.20)

\* Values in parentheses: Standard deviation. / *Vrijednosti u zagradama standardna su devijacija.*  
Letters in columns: Duncan test results. / *Slova u stupcima označavaju rezultate Duncanova testa.*

of weathering, no statistical difference was found between the individual use of 1 % or 2 % alum.

#### 4 CONCLUSIONS

##### 4. ZAKLJUČAK

Dyestuff was used for dyeing bleached pulp produced via the chemical-thermo-mechanical pulp (CTMP) method. In order to obtain dyestuff, the bark, water and KOH were used in addition to alum as a mordant to increase the color fastness. According to the accelerated aging results, it was observed that the alum had a significant effect on total color change. The statistical analysis results of the total color change values support this case. The medium in which the cherry wood bark was boiled (water, 1-2 % KOH) had an effect on total color change; however, this was not significant at the 95 % confidence interval.

It was observed that the gloss of the cherry wood bark paper was significantly preserved. No significant change occurred in the first 25 h, while slight changes occurred in the gloss values after 25 h. After 150 h of weathering, the minimum gloss value was found in the 1 % Alum + 1 % KOH group. The opacity values of papers produced using alum and KOH differed from the control samples before the weathering test, although statistically there was no significant difference between them. However, with 150 hours of the weathering process, they exhibited different opacity behaviors. In all media, the maximum opacity value was obtained with 1 % KOH. Therefore, it can be said that the use of 1 % KOH in the production of the dyestuff increased the ratio of dyestuff extracted from the bark.

#### 5 REFERENCES

##### 5. LITERATURA

1. Ali, S.; Hussain, T.; Nawaz, R. 2009: Optimization of alkaline extraction of natural dye from Henna leaves and its dyeing on cotton by exhaust method. *Journal of Cleaner Production*, 17 (1): 61-66.  
<https://doi.org/10.1016/j.jclepro.2008.03.002>.
2. Bechtold, T.; Mahmud-Ali, A.; Mussak, R. A., 2007: Re-use of ash-tree (*Fraxinus excelsior* L.) bark as natural dyes for textile dyeing: Process conditions and process stability. *Coloration Technology*, 123 (4): 271-279.  
<https://doi.org/10.1111/j.1478-4408.2007.00095.x>.
3. Casey, J. P., 1960: *Pulp and Paper Chemistry and Chemical Technology II*. New York: Interscience Publishers, Inc., pp. 955-1000.
4. Clark, J. D. A., 1978: *Fibrillation and fiber bonding. Pulp technology and treatment for paper (A Pulp and Paper Book)*. M. Freeman Publications, pp. 160-180.
5. Feng, X. X.; Zhang, L. L.; Chen, J. Y.; Zhang, J. C., 2007: New insights into solar UV-protective properties of natural dye. *Journal of Cleaner Production*, 15 (4): 366-372.  
<https://doi.org/10.1016/j.jclepro.2005.11.003>.
6. Gençer, A., 2015: The utilization of Kiwi (*Actinidia deliciosa*) prunings waste for kraft paper and the effect of the bark on paper properties. *Drewno*, 58 (194): 103-113.  
<https://doi.org/10.12841/wood.1644-3985.084.08>.
7. Gencer, A.; Can, A., 2016: Investigation of dyestuff obtained from Elderberry (*Sambucus Nigra* L.) Seeds in the coloring Process of Paper. *International Forestry Symposium (IFS 2016)*, pp. 736-740, 07-10 December 2016, Kastamonu, Turkey.
8. Gençer, A.; Gül Türkmen, H., 2016: Determination of paper production conditions of wild cherry heartwood and sapwood. *Journal of Bartın Faculty of Forestry*, 18 (1): 23-31.

9. Gençer, A.; Eroğlu, H.; Karakurt, H., 2006: Utilization of Black Liquor from KOH-Air Paper Pulp Production Method as a Fertilizer in Broad Beans (*Vicia faba*) Cultivation. *Ecology*, 15 (61): 56-60.
10. Gençer, A.; Onat, S. M.; Can, A.; Özgül, U.; Sivrikaya, H.; Yurdakurban, F., 2016: Effect of sodium ascorbate on weathering performance of NaOH pulping and paper. *Drewno*, 59 (198): 49-60. <https://doi.org/10.12841/wood.1644-3985.171.11>.
11. Hale, D. J., 1969: *Pulp and Paper Manufacture*, 2<sup>nd</sup> ed., vol. I. The Pulping of Wood. McGraw-Hill Book Company.
12. Hon, D., 1981: Yellowing of Modern Papers, Preservation of Paper and Textiles of Historic and Artistic Value. American Chemical Society. *Advances in Chemistry*, 193, Chapter 10: 119-141. <https://doi.org/10.1021/ba-1981-0193.ch010>.
13. Khan, M. A.; Ul-Islam, S.; Mohammad, F., 2016: Extraction of natural dye from walnut bark and its dyeing properties on wool yarn. *Journal of Natural Fibers*, 13 (4): 458-469. <https://doi.org/10.1080/15440478.2015.1055033>.
14. Konuklar, M., 2011: A new method investigation of paper conservation, Doctoral thesis. Ankara University, Institute of Natural and Applied Sciences, Ankara.
15. Mirjalili, M.; Nazarpour, K.; Karimi, L., 2011: Extraction and identification of dye from walnut green husks for silk dyeing. *Asian Journal of Chemistry*, 23 (3): 1055.
16. Peşman, E., 2010: Determination of ink removal and bleaching properties of old news and magazine papers, Doctoral thesis. Karadeniz Technical University, Institute of Natural and Applied Sciences, Trabzon.
17. Reddy, N.; Yang, Y., 2009: Properties and potential applications of natural cellulose fibers from the bark of the cotton stalks. *Bioresource Technology*, 100 (14): 3563-3569. <https://doi.org/10.1016/j.biortech.2009.02.047>.
18. Stavropoulos, W. S., 1988: What can packaging manufacturers do about municipal solid waste? *TAPPI Journal*, 71 (3): 209-211.
19. Suchsland, O.; Woodson, G. E., 1986: *Fiberboard Manufacturing Practices in the United States*. United States Department of Agriculture, Forest Service, Agriculture Handbook No. 640: 263.
20. Tutak, M.; Benli, H., 2012: Dyeing properties of textiles by Turkish hazelnut (*Corylus colurna*): leaves, coat, shell and dice. *Coloration Technology*, 128 (6): 454-458. <https://doi.org/10.1111/j.1478-4408.2012.00399.x>.
21. Zou, H.; Liukkonen, B.; Genco, C. J.; Miller, W., 2000: Influence of kraft pulping on the kinetics of oxygen delignification. *TAPPI Journal*, 83 (2): 65-71.
22. \*\*\*ASTM G53, 1988: Standard practice for operating light and water exposure apparatus for exposure of non-metallic materials.\*\*\*ISO 5269-2, 2013: Pulps preparation of laboratory sheets for physical testing. Part 2: Rapid-Köthem method.
23. \*\*\*ISO 7724-2, 1984: Paints and varnishes-Colorimetry. Part 2: Color measurement, ISO Standard.
24. \*\*\*TAPPI T519 om-02, 2002: Diffuse Opacity of Paper (d/0 paper backing).

**Corresponding address:**

AHMET CAN

Bartın University  
Faculty of Forestry  
Department of Forest Industrial Engineering  
74100 Bartın, TURKEY  
e-mail: [acan@bartin.edu.tr](mailto:acan@bartin.edu.tr); [6116acan@gmail.com](mailto:6116acan@gmail.com)

Elif Topaloglu<sup>1</sup>

# Effect of Accelerated Weathering Test on Selected Properties of Bamboo, Scots Pine and Oriental Beech Wood Treated with Waterborne Preservatives

Utjecaj ubrzanog izlaganja vremenskim utjecajima na svojstva bambusa, drva bora i drva bukve obrađenih zaštitnim sredstvima na bazi vode

**Original scientific paper • Izvorni znanstveni rad**

Received – prispjelo: 12. 12. 2018.

Accepted – prihvaćeno: 20. 11. 2019.

UDK: 630\*812.31; 630\*812.71; 630\*812.72; 630\*814.11; 630\*829

<https://doi.org/10.5552/drvind.2019.1855>

**ABSTRACT** • This paper investigates the changes in density, compression strength parallel to grain, static modulus of rupture and modulus of elasticity of untreated (control) and waterborne-treated bamboo (*Phyllostachys bambusoides*), Scots pine (*Pinus sylvestris*) and Oriental beech (*Fagus orientalis*) specimens subjected to accelerated weathering using an accelerated weathering chamber for 672 hours. Wolmanit-CB (CCB), tanalith-E (Tan-E), amine copper quat-1900 (ACQ) and boric acid-borax (BB) were used as waterborne preservatives. The retention value of bamboo specimens was lower than that of wood specimens due to the difference in anatomical structure of bamboo. The value of density, compression strength parallel to grain, static modulus of rupture and modulus of elasticity of treated bamboo and wood were generally higher than those of untreated specimens after accelerated weathering. ACQ treatment generally provided the best protection against weathering in all mechanical tests for both bamboo and wood specimens, while CCB treatment provided an effective protection against weathering in compression strength for Oriental beech. BB treatment provided the least protection against weathering for bamboo and wood specimens compared to other waterborne preservatives.

**Keywords:** accelerated weathering, bamboo, mechanical properties, waterborne preservative, wood

**SAŽETAK** • U radu je istraživana promjena gustoće, čvrstoće na tlak u smjeru vlaknaca, modula loma i modula elastičnosti neobrađenih (kontrolnih) uzoraka i uzoraka obrađenih zaštitnim sredstvima na bazi vode nakon 672

<sup>1</sup> Author is assistant professor at Giresun University, Technical Sciences Vocational School, Department of Architecture and Urban Planning, Giresun, Turkey.

<sup>1</sup> Autor je docent Sveučilišta Giresum, Strukovna škola tehničkih znanosti, Zavod za arhitekturu i urbanizam, Giresun, Turska.

sata ubrzanog izlaganja vremenskim utjecajima u komori. Kao zaštitna sredstva na bazi vode primijenjeni su Wolmanit-CB (CCB), tanalith-E (Tan-E), aminski bakreni quat-1900 (ACQ) i borna kiselina – boraks (BB). Zbog razlike u anatomskoj građi retencija uzoraka bambusa bila je manja od retencije uzoraka drva. Nakon ubrzanog izlaganja vremenskim utjecajima vrijednosti gustoće, čvrstoće na tlak u smjeru vlaknaca, modula loma i modula elastičnosti uzoraka bambusa i drva obrađenih zaštitnim sredstvima na bazi vode bile su veće od vrijednosti neobrađenih uzoraka. Zaštitno sredstvo ACQ u osnovi je osiguralo najbolju zaštitu pri izlaganju vremenskim utjecajima, što se pokazalo u svim mehaničkim ispitivanjima uzoraka bambusa i drva, dok je zaštitnim sredstvom CCB postignuta odgovarajuća zaštita bukova drva od vremenskih utjecaja glede čvrstoće na tlak. Zaštitno sredstvo BB pokazalo je najmanju sposobnost zaštite uzoraka bambusa i drva pri izlaganju vremenskim utjecajima od ostalih zaštitnih sredstava na bazi vode.

**Ključne riječi:** ubrzano izlaganje vremenskim utjecajima, bambus, mehanička svojstva, zaštitna sredstva na bazi vode, drvo

## 1 INTRODUCTION

### 1. UVOD

The slow deterioration of materials subjected to the weather is defined as weathering. The reasons for deterioration are factors such as sunlight, moisture, chemicals, abrasion by wind and biological factors (Rowell, 2005). Deterioration processes by weathering cause changes in the physical, chemical and mechanical properties of materials (Wang *et al.*, 2005; Beg and Pickering, 2008; Azwa *et al.*, 2013). Wood, a natural durable material, is known all over the world for its functional and attractive engineering and constructional properties. Wood material is subject to environmental deterioration as other biological materials. A combination of heat, light and water causes weathering when wood is exposed to the outdoors above ground (Feist and Hon, 1984), and the service life of wood is affected adversely, especially when used outdoors (Asif, 2009). The ultraviolet (UV) radiation is an important factor that initiates the process of weathering. The UV radiation degrades wood structural components (lignin and carbohydrates) (Williams, 2005; Miklečić and Jirouš-Rajković, 2011). During the process of weathering the appearance of wood changes and wood fibers gradually deteriorate (Lebow and Anthony, 2012). Original surfaces become rough and the color of these surfaces changes, and wood becomes brittle by losing its surface coherence during outdoor weathering of smooth wood. Lignin degradation occurs when the UV light is absorbed by lignin on the wood surface, and the loss of strength and of polymerization degree occurs when cellulose is exposed to sunlight (Feist, 1983; Feist and Hon, 1984). Also, Feist (1983) stated that the various weathering effects (physical, chemical, etc.) have little effect on compressive strength, modulus of rupture and modulus of elasticity of wood.

Bamboo, a rapid growing plant, is used for a wide variety purposes such as household products, furniture, building applications, and in construction as structural materials (Lee *et al.*, 2001; Li, 2004). Color changes and cracks occur on the surface of the bamboo used in external conditions and exposed to UV light. This reduces the quality of bamboo and affects its use in external conditions (Yu *et al.*, 2018). Furthermore, bamboo is known to be subject to attack by moulds and blue stain infestation. Improving the durability of bamboo, which has rapid

growing, high strength, low price, and biodegradability properties, is important for uses such as building and construction materials (Kim *et al.*, 2008). Different impregnation methods have been applied with different preservatives in order to enhance the service life of bamboo and investigate the durability of bamboo. Various studies were performed on basidiomycete tests and soft rot tests by Leithoff and Peek (2001), on the termite and decay resistance as a field trial by Jiang (2008), on the decay fungi attack by Wahab *et al.* (2006), on mould fungi attack by Sun *et al.* (2012), on termite resistance by Manalo and Garcia (2012), and on fungal resistance by Kumar *et al.* (2018).

Wood can be protected against weathering, and the preservative and finishing treatments can improve its durability (Asif, 2009). Chromic acid, chemical modification, paints and stains, water repellent preservatives and copper-based preservatives are among the methods that protect wood against weathering (Williams, 2005). Also, acetylation, etherification and grafting benzophenone UV light absorbers are methods that protect wood surface against photodiscoloration (Rowell *et al.*, 1993; Grelier *et al.*, 2000). The preservatives can be generally classified into three groups: (1) preservative oils, (2) organic solvent solutions, (3) waterborne salts (Feist and Hon, 1984). Impregnation applied with water-soluble salts such as copper, chromium and iron is one of the methods used to protect wood materials against UV effect (Temiz, 2005). There are many types of waterborne preservatives, and they are suitable for indoor and outdoor uses and contribute to the reduction of weathering effects on wood in service. Copper, chromate and arsenic (CCA) compounds are generally known formulations, but copper-chromium and copper-chromium-boron combinations are also used (Asif, 2009). In addition, ammoniacal copper borate (ACB), ammoniacal copper zinc arsenate (ACZA), copper quaternary (ACQ), copper xylogen (CX-A), and copper azole (CA-B) are among the water-borne soluble copper formulations used in recent years (Lebow *et al.*, 2003; Freeman and McIntyre, 2008). Winandy (1988) stated that waterborne preservative formulations generally may reduce the resistance of wood because they oxidize the component of wood cell wall. Furthermore, boron compounds, such as boric acid (BA) and borax (BX), are well known preservative chemicals especially used as fire retardants to protect

wood (Toker *et al.*, 2008; Simsek and Baysal, 2015). The low mammalian toxicity, low volatility and protection of wood against fungi and insects, are considered as advantages of borates, but its important disadvantage is weak resistance against leaching from the treated wood (Yalinkilic *et al.*, 1999; Baysal *et al.*, 2007). Simsek *et al.* (2010) found that the modulus of rupture and compression strength parallel to grain of Oriental beech and scots pine, treated with aqueous solutions of borates, decreased. Toker *et al.* (2008) determined that borate treatments reduced compression strength parallel to grain of Calabrian pine and Oriental beech wood compared to untreated wood.

In literature, there is more information on the weathering of treated and/or untreated wood than on bamboo. However, there are few reports on the effect of accelerated weathering on physical and mechanical properties of treated and/or untreated bamboo. The mechanical properties of both wood and bamboo, as industrial material in outdoor conditions, are important for use. This study aims to reveal the effect of accelerated weathering on various properties of untreated and waterborne-treated bamboo (*Phyllostachys bambusoides*), Oriental beech (*Fagus orientalis*) and Scots pine (*Pinus sylvestris*) specimens, and to evaluate the performance of the preservatives used in this study. Untreated and waterborne-treated test specimens were exposed to accelerated weathering test and the changes in density, compression strength parallel to grain, static modulus of rupture and modulus of elasticity were compared with those of untreated specimens.

## 2 MATERIALS AND METHODS

### 2. MATERIJALI I METODE

#### 2.1 Materials

##### 2.1. Materijali

The experimental materials of the study, bamboo culms and Scots pine and Oriental beech logs, were taken from Trabzon, Turkey. The selected bamboo culms have a bottom diameter of 45 mm, a top diameter of 30 mm, and a length of 8-9 m. Bottom portions of culms were used in order to obtain the maximum wall thickness required for measurements. Node parts of bamboo culms were cut out because node parts have a complicated structure and reduce strength properties (Tomak *et al.*, 2012). The wood specimens were cut from sapwood part of stem woods without branches and bamboo specimens were cut from internode section of culms, both of the same dimensions. Then, all specimens were placed in an air conditioning room with a temperature of 20 °C and a relative humidity of 65 % for four weeks before the impregnation process.

#### 2.2 Impregnation process and accelerated weathering test

##### 2.2. Postupci impregniranja i ubrzano izlaganje vremenskim utjecajima

Four wood preservatives with 3 % aqueous solutions were used: BB as a mixture of boric acid and borax (7:3 ratio), amine copper quat-1900 (ACQ), wolmanit-CB (CCB) and tanalith-E (Tan-E). First, vacuum

at 600 mm/Hg was applied on test specimens for 30 minutes, and then atmospheric pressure was applied for 60 minutes. As the retention values of the Scots pine and bamboo specimens were determined in our previous study (Baysal *et al.* 2016), beech wood specimens were weighted to determine the amount of preservative solution absorbed (*G*) in this study. In order to provide the fixation of copper based preservatives, the specimens were kept for 7 days in room conditions. Then, test specimens were conditioned at 20 °C temperature and 65 % relative humidity for three weeks. The retention value was calculated for beech wood specimens according to Eq 1,

$$R = (G \times C) / V \times 10 \quad (1)$$

Where *G* is the amount of preservative solution absorbed by test specimens (kg), *C* is the concentration of preservative solution (%) and *V* is the volume of test specimens (m<sup>3</sup>).

The accelerated weathering test was carried out in a QUV weathering test device (Q-Lab, USA) according to ASTM G154 (2012) standard. Test specimens were subjected to 8 h UV light irradiation followed by 4 h condensation in the QUV weathering test device. The mean irradiance was 0.89 W/m<sup>2</sup> at 340 nm wavelengths. The temperature of the condensation cycle was 50 °C and the temperature of the light irradiation cycle was 60 °C. The test specimens were exposed to a total of 672 hours of weathering for 4 weeks.

#### 2.3 Density measurement

##### 2.3. Mjerenje gustoće

Small clear specimens with dimensions of 4 mm × 10 mm × 20 mm (radial × tangential × longitudinal) were used for density measurement. Treated and untreated specimens were dried to constant mass at (103±2) °C oven dry temperature after the accelerated weathering test. The dried specimens were weighed on a precision scale, and their three dimensions were measured by digital calipers and their volumes were calculated. Oven-dry density (g/cm<sup>3</sup>) was determined by dividing oven dry mass (g) of specimen by oven dry volume (cm<sup>3</sup>) of the specimen (Baysal *et al.*, 2004).

#### 2.4 Mechanical tests

##### 2.4. Mehanička ispitivanja

Static modulus of rupture (*MOR*), static modulus of elasticity (*MOE*), and compression strength parallel to grain (*CS*) of treated and untreated specimens were tested by a universal testing machine after the accelerated weathering test. Static *MOR* and *MOE* test specimens, with 4 mm in depth, 10 mm in width and 200 mm in length, were applied to three-point bending test with a span of 150 mm, as reported by Tran (2010). Test specimens, with dimensions of 4 mm in depth, 10 mm in width and 20 mm in length, were used for compression strength parallel to grain test. Static *MOR* and *MOE*, and *CS* tests were carried out according to ISO 13061-3, ISO 13061-4 and ISO 13061-17 standards, respectively, with modified specimen dimensions. For determination of density and mechanical properties, ten specimens were used for each group, treated and untreated.

**2.5 Statistical analysis**

2.5. Statistička analiza

The effect of accelerated weathering on density, static MOR and MOE, and compression strength of test specimens in comparison with untreated specimens was analyzed with a significance level of 5 %. One-way analysis of variance (ANOVA) was performed and Duncan test was applied to identify the differences among treatments.

**3 RESULTS AND DISCUSSION**

3. REZULTATI I RASPRAVA

**3.1 Retention of preservatives in test specimens**

3.1. Retencija zaštitnih sredstava u uzorcima

Table 1 presents the retention values of preservatives in bamboo, Scots pine and Oriental beech specimens.

The retention values of preservatives in bamboo and Scots pine were determined in our previous study (Baysal *et al.*, 2016). As shown in Table 1, the retention values of bamboo, Scots pine and Oriental beech specimens ranged from 4.63-4.88 kg/m<sup>3</sup>, 14.61-16.32 kg/m<sup>3</sup> and 14.16-15.59 kg/m<sup>3</sup>, respectively. Lee *et al.* (2001) determined that the average CCA retentions of bamboo and southern pine specimens were 1.49 and 0.88 kg/m<sup>3</sup>, and 7.12 and 4.61 kg/m<sup>3</sup>, respectively. They reported that the preservative penetration of bamboo was more difficult than that of southern pine under similar impregnation requirements. In this study, retention values of wood were relatively higher than those of bamboo. Anatomical properties of bamboo culm affect preservation treatment, and the lateral flow of liquids is limited because bamboo has radial cells only in the node section (Tang, 2013). ANOVA showed that the difference between the retention values was significant ( $p < 0.05$ ) for Oriental beech and Scots pine, while the difference

was insignificant ( $p > 0.05$ ) for bamboo. The highest retention values of Oriental beech and Scots pine were determined as 15.59 kg/m<sup>3</sup> and 16.32 kg/m<sup>3</sup> for ACQ and CCB treatment, respectively. Zhou (2012) stated that the different densities and physical properties between early wood and late wood could affect the preservative distribution in treated wood. Furthermore, Ding *et al.* (2008) concluded that wood species with maximum porosities showed maximum retention ratios.

**3.2 Density values**

3.2. Vrijednosti gustoće

Density values (kg/m<sup>3</sup>) of bamboo and wood specimens are summarized in Table 2.

The density values of bamboo were relatively higher than those of wood for treated and untreated specimens. Although bamboo is a heterogeneous and lignocelluloses material like wood (Chaowana, 2013), it differs from wood in terms of many features, and differences in the anatomical characteristics of bamboo and wood result in considerably different density and surface properties of both materials (Wang and Ren, 2008). The highest density values of bamboo specimens were determined to be 760 and 770 kg/m<sup>3</sup> for bamboo treated with CCB and ACQ, respectively. The highest density values of wood specimens were determined to be 500 kg/m<sup>3</sup> for Scots pine treated with ACQ, and 710 and 720 kg/m<sup>3</sup> for Oriental beech treated with ACQ and CCB, respectively. The lowest density values were determined to be 720, 430 and 660 kg/m<sup>3</sup> for untreated specimens of bamboo, Scots pine and Oriental beech, respectively. According to test results, the treatment with waterborne preservatives, especially ACQ and CCB, increased the density of bamboo and wood specimens after weathering. This result may be attributed to the increased retention of the specimens, because as the weight per unit volume of wood increa-

**Table 1** Average retention (kg/m<sup>3</sup>) of treated bamboo and wood specimens

**Tablica 1.** Prosječna retencija (kg/m<sup>3</sup>) uzoraka bambusa i drva

Wood preservatives <i>Zaštitno sredstvo za drvo</i>	Bamboo / <i>Bambus*</i>	Scots pine / <i>Drvo bora*</i>	Oriental beech / <i>Drvo bukve</i>
TAN-E	4.78 (0.56) <sup>a</sup>	14.61 (0.46) <sup>b</sup>	14.16 (0.70) <sup>b</sup>
ACQ	4.83 (0.45) <sup>a</sup>	15.75 (0.76) <sup>ab</sup>	15.59 (0.76) <sup>a</sup>
CCB	4.88 (0.76) <sup>a</sup>	16.32 (0.47) <sup>a</sup>	14.49 (0.65) <sup>b</sup>
BB	4.63 (0.56) <sup>a</sup>	15.35 (0.71) <sup>ab</sup>	14.23 (0.62) <sup>b</sup>

Note: Standard deviations are given in parenthesis, superscript letters within columns show significant differences at the significance level of 0.05. / *Napomena: u zagradama su navedene standardne devijacije, a slova iza zagrada obilježavaju značajnu razliku uz razinu značajnosti 0,05.*

\*The results obtained from Baysal *et al.* (2016). / *Rezultati su preuzeti od Baysal et al. (2016.).*

**Table 2** Density values (kg/m<sup>3</sup>) of specimens after accelerated weathering

**Tablica 2.** Vrijednosti gustoće (kg/m<sup>3</sup>) uzoraka nakon ubrzanog izlaganja vremenskim utjecajima

Treatment / <i>Tretman</i>	<i>n</i>	Bamboo / <i>Bambus*</i>	Scots pine / <i>Drvo bora*</i>	Oriental beech / <i>Drvo bukve</i>
TAN-E	10	740 (40)ab	480 (30)ab	690 (10)b
ACQ	10	770 (30)a	500 (20)a	710 (20)a
CCB	10	760 (70)a	480 (20)ab	720 (20)a
BB	10	740 (30)ab	470 (20)b	690 (10)b
Untreated / <i>Netretirano</i>	10	720 (40)b	430 (30)c	660 (20)c

Note: Standard deviations are given in parenthesis, superscript letters within columns show significant differences at the significance level of 0.05, n is the number of specimens. / *Napomena: u zagradama su navedene standardne devijacije, slova iza zagrada obilježavaju značajnu razliku uz razinu značajnosti 0,05, n je broj uzoraka.*

ses, its density will increase. Ding *et al.* (2008) concluded that polymer retention and impregnation rate were highly correlated with wood porosity, and found that the density values of six wood species treated with methyl methacrylate increased from 45 to 130 % depending on the species.

### 3.3 Mechanical tests

#### 3.3. Mehanička ispitivanja

##### 3.3.1 Compression strength parallel to grain

###### 3.3.1. Čvrstoća na tlak u smjeru vlakana

The compression strength parallel to grain (*CS*) values of bamboo and wood specimens are presented in Table 3.

The *CS* of treated and untreated bamboo was higher compared to treated and untreated wood specimens. The highest *CS* value of bamboo specimens was determined to be 61.12 MPa for ACQ-treated specimens. The highest *CS* values of wood specimens were determined to be 38.10 MPa and 50.62 MPa for ACQ-treated Scots pine and CCB-treated Oriental beech, respectively. The lowest *CS* values were determined to be 56.82 MPa, 34.44 MPa and 44.07 MPa for untreated bamboo, Scots pine and Oriental beech specimens, respectively. According to the results of ANOVA test, the significant differences ( $p < 0.05$ ) were found among the treatment groups after accelerated weathering, and these differences were clearer for Scots pine and Oriental beech than for bamboo (Table 3). The results showed that all treated bamboo and wood specimens had higher *CS* values compared to untreated control after accelerated weathering. Copper based preservatives are formed in waterborne formulations and copper decelerates photodegradation caused by UV radiation (Freeman and McIntyre, 2008). In addition, Cornfield *et al.* (1994) found that CCA and copper azole protect the wood against weathering and found no loss of lignin on the surface of impregnated and weathered samples. The above mentioned results may be the reason why compression strength values of treated specimens are higher than those of untreated ones after accelerated weathering.

The middle lamella of wood contains higher lignin than cell walls and photodegradation occurs in the middle lamella (Williams, 2005). Partial degradation of hemicelluloses and lignin in the first stage of weathering (Kim *et al.*, 2008) and the depolymerization of lignin and cellulose cause the reduction of some chemical, physical and biological properties of wood (Grelier *et al.* 2000). The reason why untreated speci-

mens have lower compression strength than treated specimens can be attributed to the decrease of lignin. It can be said that ACQ treatment for bamboo and Scots pine, and CCB treatment for Oriental beech provided the most effective protection, while BB was the least effective preservative against accelerated weathering. For bamboo, TAN-E provided a protective effect close to that of ACQ, while CCB and BB had the same protective effect. The protective efficiency of preservatives for Scots pine and Oriental beech, respectively, can be listed as follows: ACQ>Tan-E>CCB>BB>Untreated and CCB>ACQ>Tan-E>BB>Untreated.

The copper based preservatives have more effect on compression strength than boron compounds. This is probably related to the fact that copper slows photodegradation by UV radiation and water (Freeman and McIntyre, 2008). The increase in the amount of absorbed copper with the increase of the amount of lignin in wood was reported by Temiz *et al.* (2004). In addition, the increasing lignin content has a positive effect on compression strength (Gindl and Teischinger, 2002). Borate treatments decreased compression strength parallel to grain of wood specimens compared to untreated control specimens (Simsek *et al.*, 2010). In addition, Toker *et al.* (2008) reported that the compression strength of beech and pine specimens treated with boron compounds was lower than that of untreated control specimens. According to the results of this study, BB treatment was the least effective preservative; however, it provided protection against weathering in compression strength of Scots pine and Oriental beech but not of bamboo specimens.

##### 3.3.2 Static modulus of rupture and modulus of elasticity

###### 3.3.2. Modul loma i modul elastičnosti

The static modulus of rupture (*MOR*) and modulus of elasticity (*MOE*) values of bamboo and wood specimens are given in Table 4.

As shown in Table 4, the static *MOR* and *MOE* values of bamboo were higher than those of wood specimens. As reported by Huang and Fei (2017), bamboo fibres had more strength, elasticity and ductility than pine and fir fibres. In addition, the parenchymatous ground tissue and vascular bundles that are embedded in it define the anatomical structure of bamboo, while wood is composed of assorted types of cells such as parenchyma cell, tracheid and fibre (Wang and Ren, 2008). The highest *MOR* values were found to be 180.40 MPa,

**Table 3** Compression strength values (MPa) of specimens after accelerated weathering

**Tablica 3.** Vrijednosti čvrstoće na tlak (MPa) uzoraka nakon ubrzanog izlaganja vremenskim utjecajima

Treatment / <i>Tretman</i>	<i>n</i>	Bamboo / <i>Bambus</i> *	Scots pine / <i>Drvo bora</i> *	Oriental beech / <i>Drvo bukve</i>
TAN-E	10	60.01 (2.49)ab	37.43 (0.36)b	47.35 (0.39)c
ACQ	10	61.12 (2.90)a	38.10 (0.04)a	49.31 (0.36)b
CCB	10	58.22 (2.14)bc	37.13 (0.29)c	50.62 (0.32)a
BB	10	58.18 (2.04)bc	36.19 (0.33)d	46.06 (0.33)d
Untreated / <i>Netretirano</i>	10	56.82 (2.17)c	34.44 (0.34)e	44.07 (0.45)e

Note: Standard deviations are given in parenthesis, superscript letters within columns show significant differences at the significance level of 0.05, *n* is the number of specimens. / *Napomena:* u zagradama su navedene standardne devijacije, slova iza zagrada obilježavaju značajnu razliku uz razinu značajnosti 0,05, *n* je broj uzoraka.



**Table 4** Static *MOR* and *MOE* values (MPa) of specimens after accelerated weathering

**Tablica 4.** Vrijednosti *MOR* i *MOE* (MPa) uzoraka nakon ubrzanog izlaganja vremenskim utjecajima

Treatment <i>Tretman</i>	<i>n</i>	<i>MOR</i>			<i>MOE</i> ( $\times 10^2$ )		
		Bamboo <i>Bambus*</i>	Scots pine <i>Drvo bora*</i>	Oriental beech <i>Drvo bukve</i>	Bamboo <i>Bambus*</i>	Scots pine <i>Drvo bora*</i>	Oriental beech <i>Drvo bukve</i>
TAN-E	10	175.60 (3.66) <sup>b</sup>	89.40 (1.17) <sup>a</sup>	116.50 (1.72) <sup>b</sup>	157.40 (14.70) <sup>a</sup>	91.75 (2.73) <sup>b</sup>	118.34 (4.34) <sup>b</sup>
ACQ	10	180.40 (4.40) <sup>a</sup>	90.60 (2.32) <sup>a</sup>	121.00 (1.05) <sup>a</sup>	158.53 (11.81) <sup>a</sup>	96.81 (2.43) <sup>a</sup>	122.90 (4.77) <sup>a</sup>
CCB	10	175.20 (3.49) <sup>b</sup>	85.30 (1.89) <sup>b</sup>	112.60 (2.32) <sup>c</sup>	157.65 (12.62) <sup>a</sup>	95.20 (2.89) <sup>a</sup>	113.90 (4.56) <sup>c</sup>
BB	10	171.20 (3.21) <sup>c</sup>	85.20 (1.69) <sup>b</sup>	106.10 (2.28) <sup>d</sup>	144.25 (11.91) <sup>b</sup>	90.52 (3.89) <sup>b</sup>	110.95 (4.18) <sup>cd</sup>
Untreated <i>Netretirano</i>	10	168.00 (4.24) <sup>c</sup>	79.03 (0.68) <sup>c</sup>	105.30 (2.06) <sup>d</sup>	142.73 (14.28) <sup>b</sup>	85.10 (2.21) <sup>c</sup>	108.31 (3.63) <sup>d</sup>

Note: Standard deviations are given in parenthesis, superscript letters within columns show significant differences at the significance level of 0.05, *n* is the number of specimens. / Napomena: u zagradama su navedene standardne devijacije, slova iza zagrada obilježavaju značajnu razliku uz razinu značajnosti 0,05, *n* je broj uzoraka.

90.60 and 89.40 MPa, and 121 MPa for ACQ-treated bamboo, ACQ and Tan-E-treated Scots pine, and ACQ-treated Oriental beech, respectively. Generally, the ACQ-treated bamboo and wood specimens showed higher *MOR* values than those of other preservatives. It was understood that Tan-E provided an effective protection to the *MOR* strength of Scots pine – similar to that of ACQ (Table 4). The lowest *MOR* values were determined to be 168 and 171.20 MPa, 79.03 MPa, and 105.30 and 106.10 MPa for untreated and BB-treated bamboo, untreated Scots pine, and untreated and BB-treated Oriental beech, respectively. These results indicated that BB was not effective for the *MOR* strength of bamboo and Oriental beech against weathering. Tan-E and CCB provided the same protection against weathering for bamboo specimens, while Tan-E and ACQ provided the same protection for Scots pine. The *MOR* values of Oriental beech specimens after 672 h of accelerated weathering test were classified as follows: ACQ>Tan-E>CCB>BB=Untreated.

The highest *MOE* values were found to be 158.53 ( $\times 10^2$ ), 157.65 ( $\times 10^2$ ) and 157.40 ( $\times 10^2$ ) MPa, 96.81 ( $\times 10^2$ ) and 95.20 ( $\times 10^2$ ) MPa, and 122.90 ( $\times 10^2$ ) MPa for ACQ, CCB and Tan-E-treated bamboo, ACQ and CCB-treated Scots pine, and ACQ-treated Oriental beech specimens, respectively. The lowest *MOE* values were determined to be 142.73 ( $\times 10^2$ ) and 144.25 ( $\times 10^2$ ) MPa, 85.10 ( $\times 10^2$ ) MPa, and 108.31 ( $\times 10^2$ ) MPa for untreated and BB-treated bamboo, untreated Scots pine, and untreated Oriental beech specimens, respectively. ACQ, Tan-E and CCB for *MOE* of bamboo; ACQ and CCB for *MOE* of Scots pine and ACQ for *MOE* of Oriental beech provided an effective protection against weathering. BB did not provide an effective protection for *MOE* of bamboo and Oriental beech, while it provided protection against weathering for *MOE* of Scots pine. ANOVA test results revealed that there were significant differences ( $p<0.05$ ) in *MOR* and *MOE* values for bamboo and wood specimens. In general, ACQ treatment provided the most effective protection for both *MOR* and *MOE* of bamboo and wood specimens after accelerated weathering in this study. Yildiz *et al.* (2004) found that Tanalith E-3491 increased the modulus of elasticity and ACQ-1900 increased the modulus of rupture of yellow pine, while Wolmanit CX-8 increased both modulus of rupture and modulus of elasticity of yellow pine compared to control. Liu *et al.* (1994)

searched the effect of copper chemicals on the natural weathering of treated southern yellow pine early wood. They determined that 2 % ACQ provided more effective protection against weathering than other preservatives.

Results showed that BB treatment did not provide effective protection against accelerated weathering for *MOR* and *MOE* of bamboo and Oriental beech specimens, while providing effective protection for Scots pine. Toker *et al.* (2009) reported that boron compounds induced a decrease in *MOR* and *MOE* values of pine and beech specimens. The treated timber has poor or good resistance to weathering depending on the type of preservative (Feist and Williams, 1991; Cornfield *et al.*, 1994). Chemicals usually used in waterborne salt preservatives, such as copper, chromium, arsenic, and ammonia, possibly cause damage to mechanical properties of wood by interacting with it (Lebow, 2010). Bendtsen *et al.* (1983) found that ammoniacal copper arsenate (ACA) and chromated copper arsenate (CCA) preservatives did not adversely affect the modulus of elasticity of longleaf pine sapwood, and CCA reduced modulus of rupture depending on kiln drying, while ACA had no effect on modulus of rupture. Despite the above-mentioned and although certain preservatives influence the wood strength, they can also provide protection against or during weathering. Furthermore, Liu *et al.* (1994) concluded that ACQ treatment decelerated primarily the photodegradation of wood by hindering the formation of carbonyls and delignification during weathering. The results of this study revealed that the compression strength of untreated and weathered Scots pine and Oriental beech specimens were significantly lower than those of the treated and weathered ones. In addition, *MOR* and *MOE* of the untreated and weathered Scots pine specimens were significantly lower than those of the treated and weathered ones. The reductions in the strength values of untreated and weathered specimens may be associated with the breakdown and depolymerization of lignin and cell wall components during weathering (Derbyshire and Miller, 1981; Feist, 1983).

#### 4 CONCLUSIONS

##### 4. ZAKLJUČAK

In this study, the effect of accelerated weathering on density, compression strength parallel to grain, sta-

tic modulus of rupture and modulus of elasticity of bamboo and wood specimens treated with waterborne preservatives was examined. The retention value of bamboo was relatively lower than that of Scots pine and Oriental beech specimens due to the difference in anatomical structure of bamboo. All the preservatives increased the density of bamboo, Scots pine and Oriental beech specimens compared to untreated specimens. ACQ treatment for bamboo and Scots pine, and CCB treatment for Oriental beech showed the best protection against weathering in compression strength. ACQ treatment provided the best protection against weathering in *MOR* and *MOE* for both bamboo and wood specimens. BB was the preservative with the least effect on preserving the strength values of the bamboo and wood specimens against weathering. The results obtained in this study are considered to be important in the selection of waterborne preservatives to be used against weathering for both wood and bamboo.

#### Acknowledgements – Zahvala

The author would like to thank Prof. Dr. Ergun Baysal for accelerated weathering test measurements at the Department of Woodworking Industrial Engineering, Mugla Sitki Kocman University, Turkey.

## 5 REFERENCES

### 5. LITERATURA

- Asif, M., 2009: Sustainability of timber, wood and bamboo in construction, Sustainability of Construction Materials. Khatib, J. M. (ed.): Woodhead Publishing, Cambridge, UK, 31-54.
- Azwa, Z. N.; Yousif, B. F.; Manalo, A. C.; Karunasena, W., 2013: A review on the degradability of polymeric composites based on natural fibres. *Materials and Design*, 47: 424-442.
- Baysal, E.; Peker, H.; Colak, M., 2004: Physical properties of heaven wood treated with borates and water repellents. *Erciyes University Science Institute Journal*, 20 (1): 55-65.
- Baysal, E.; Yalinkilic, M. K.; Altinok, M.; Sonmez, A.; Peker, H.; Colak, M., 2007: Some physical, biological, mechanical, and fire properties of wood polymer composite (WPC) pretreated with boric acid and borax mixture. *Construction and Building Materials*, 21 (9): 1879-1885. <https://doi.org/10.1016/j.conbuildmat.2006.05.026>.
- Baysal, E.; Tomak, E. D.; Topaloglu, E.; Pesman, E., 2016: Surface properties of bamboo and Scots pine impregnated with boron and copper based wood preservatives after accelerated weathering. *Maderas. Ciencia y tecnología*, 18 (2): 253-264. <http://dx.doi.org/10.4067/S0718-221X2016005000023>.
- Beg, M. D. H.; Pickering, K. L., 2008: Accelerated weathering of unbleached and bleached kraft wood fibre reinforced polypropylene composites. *Polymer Degradation and Stability*, 93 (10): 1939-1946. <https://doi.org/10.1016/j.polymdegradstab.2008.06.012>.
- Bendtsen, B. A.; Gjovik, L. R.; Verrill, S. P., 1983: Mechanical properties of longleaf pine treated with waterborne salt preservatives. Research paper FPL-United States Department of Agriculture, Forest Service, Forest Products Laboratory (USA).
- Chaowana, P., 2013: Bamboo: An alternative raw material for wood and wood-based composites. *Journal of Materials Science Research*, 2 (2): 90-102. <https://doi.org/10.5539/jmsr.v2n2p90>.
- Cornfield, J. A.; Hale, B.; Fettis, G., 1994: A comparison of analytical and visual techniques used for assessment of weathering properties of chromium and copper azole treated timber. International Research Group on Wood Preservation IRG/WP 94-20023.
- Derbyshire, H.; Miller, E. R., 1981: The photodegradation of wood during solar irradiation. *Holz als Roh- und Werkstoff*, 39 (8): 341-350. <https://doi.org/10.1007/bf02608404>.
- Ding, W. D.; Koubaa, A.; Chaala, A.; Belem, T.; Krause, C., 2008: Relationship between wood porosity, wood density and methyl methacrylate impregnation rate. *Wood Material Science and Engineering*, 3 (1-2): 62-70. <https://doi.org/10.1080/17480270802607947>.
- Feist, W. C., 1983: Weathering and protection of wood. In: Proceedings, seventy-ninth annual meeting of the American Wood-Preservers' Association, April 17-20, Kansas City, 79: 195-205.
- Feist, W. C.; Hon, D. N. S., 1984: Chemistry of weathering and protection. In: Rowell, R. M. (ed.): The chemistry of solid wood. Advances in chemistry series 207. Washington, DC: American Chemical Society, pp. 401-451 (Chapter 11).
- Feist, W. C.; Williams, R. S., 1991: Weathering durability of chromium-treated southern pine. *Forest Products Journal*, 41 (1): 8-14.
- Freeman, M. H.; McIntyre, C. R., 2008: A comprehensive review of copper-based wood preservatives. *Forest Products Journal*, 58 (11): 6-27.
- Gindl, W.; Teischinger, A., 2002: Axial compression strength of Norway spruce related to structural variability and lignin content. *Composites, Part A: Applied Science and Manufacturing*, 33 (12): 1623-1628. [https://doi.org/10.1016/s1359-835x\(02\)00182-3](https://doi.org/10.1016/s1359-835x(02)00182-3).
- Grelier, S.; Castellan, A.; Kamdem, D. P., 2000: Photoprotection of copper-amine-treated pine. *Wood and Fiber Science*, 32 (2): 196-202.
- Huang, Y.; Fei, B., 2017: Comparison of the mechanical characteristics of fibers and cell walls from moso bamboo and wood. *BioResources*, 12 (4): 8230-8239.
- Jiang, M., 2008: Field trial of copper treated moso bamboo in Southern China. International Research Group on Wood Preservation, IRG/WP 08-30455.
- Kim, J. S.; Lee, K. H.; Cha, M. Y.; Kim, Y. S., 2008: Anatomical, physical and chemical changes of bamboo (*Phyllostachys pubescence*) during weathering processes. International Research Group on Wood Preservation, IRG/WP 08-10650.
- Kumar, A.; Ryparovà, P.; Kasal, B.; Adamopoulos, S.; Hajek, P., 2018: Resistance of bamboo scrimber against white-rot and brown-rot fungi. *Wood Material Science and Engineering*, 1-7. <https://doi.org/10.1080/17480272.2018.1475420>.
- Lebow, S.; Anthony, R. W., 2012: Guide for use of wood preservatives in historic structures. General Technical Report FPL-GTR-217. Madison, WI: U.S. Department of Agriculture, Forest Service, Forest Products Laboratory.
- Lebow, S. T., 2010: Wood preservation, Wood handbook: wood as an engineering material, chapter 15. General technical report FPL-GTR-190. Madison, WI: US Department of Agriculture, Forest Service, Forest Products Laboratory.
- Lebow, S.; Winandy, J.; Bender, D., 2003: Treated wood in transition: a look at CCA and the candidates to replace it. *Frame Building News*, p.p. 32-38.

25. Lee, A. W.; Chen, G.; Tainter, F. H., 2001: Comparative treatability of moso bamboo and southern pine with CCA preservative using a commercial schedule. *Bioresource Technology*, 77 (1): 87-88.  
[https://doi.org/10.1016/S0960-8524\(00\)00145-0](https://doi.org/10.1016/S0960-8524(00)00145-0).
26. Leithoff, H.; Peek, R. D., 2001: Heat treatment of bamboo. International Research Group on Wood Preservation IRG/WP 01-40216.
27. Li, X., 2004: Physical, chemical, and mechanical properties of bamboo and its utilization potential for fiberboard manufacturing, dissertation. Louisiana State University.
28. Liu, R.; Ruddick, J. N. R.; Jin, L., 1994: The influence of copper (II) chemicals on the weathering of treated wood. Part I. ACQ treatment of wood on its weathering. International Research Group on Wood Preservation, IRG/WP 94-30040.
29. Manalo, R. D.; Garcia, C. M., 2012: Termite resistance of thermally-modified *Dendrocalamus asper* (Schultes f.) Backer ex Heyne. *Insects*, 3 (2): 390-395.  
<https://doi.org/10.3390/insects3020390>.
30. Miklečić, J.; Jirouš-Rajković, V., 2011: Accelerated weathering of coated and uncoated beech wood modified with citric acid. *Drvna industrija*, 62 (4): 277-282.  
<https://doi.org/10.5552/drind.2011.1116>.
31. Rowell, R. M.; Lichtenberg, R. S.; Larsson, P., 1993. Stability of acetylated wood to environmental changes. *Wood and Fiber Science*, 25 (4): 359-364.
32. Rowell, R. M., 2005: Handbook of wood chemistry and wood composites. Florida: CRC Press. p.p. 487.
33. Sun, F.; Bao, B.; Ma, L.; Chen, A.; Duan, X., 2012: Mould-resistance of bamboo treated with the compound of chitosan-copper complex and organic fungicides. *Journal of Wood Science*, 58 (1): 51-56.  
<https://doi.org/10.1007/s10086-011-1223-9>.
34. Simsek, H.; Baysal, E.; Peker, H., 2010: Some mechanical properties and decay resistance of wood impregnated with environmentally-friendly borates. *Construction and Building Materials*, 24 (11): 2279-2284.  
<https://doi.org/10.1016/j.conbuildmat.2010.04.028>.
35. Simsek, H.; Baysal, E., 2015: Some physical and mechanical properties of borate-treated Oriental beech wood. *Drvna industrija*, 66 (2): 97-103.  
<https://doi.org/10.5552/drind.2015.1356>.
36. Tang, T. K. H., 2013: Preservation and drying of commercial bamboo species of Vietnam, dissertation. University Hamburg, Hamburg.
37. Temiz, A.; Yildiz, U. C.; Gezer, E. D.; Yildiz, S.; Dizman, E., 2004: Interaction of copper based preservatives with wood. *Artvin Coruh University Journal of Forestry Faculty*, 5 (2): 204-211.
38. Temiz, A., 2005: The effect of simulated weathering on preservative treated wood, PhD Thesis. Karadeniz Technical University, Trabzon, Turkey.
39. Toker, H.; Baysal, E.; Ozcifici, A.; Altınok, M.; Sönmez, A.; Yapıcı, F.; Altun, S., 2008: An investigation on compression parallel to grain values of wood impregnated with some boron compounds. *Wood Research*, 53 (4): 59-67.
40. Toker, H.; Baysal, E.; Simsek, H.; Senel, A.; Sonmez, A.; Altınok, M.; Ozcifici, A.; Yapıcı, F., 2009: Effects of some environmentally-friendly fire retardant boron compounds on modulus of rupture and modulus of elasticity of wood. *Wood Research*, 54 (1): 77-88.
41. Tomak, E. D.; Topaloglu, E.; Ay, N.; Yildiz, U. C., 2012: Effect of accelerated aging on some physical and mechanical properties of bamboo. *Wood Science and Technology*, 46 (5): 905-918.  
<https://doi.org/10.1007/s00226-011-0454-7>.
42. Tran, V. H., 2010: Growth and quality of indigenous bamboo species in the mountainous regions of Northern Vietnam, dissertation. Georg-August-Universität.
43. Wahab, R.; Sudin, M.; Mustapa, T.; Yunus, A. A. M., 2006: Durability performance of *Gigantochloa scortechinii* through laboratory fungal decay tests. *Research Journal of Microbiology*, 1 (2): 198-202.  
<https://doi.org/10.3923/jm.2006.198.202>.
44. Wang, W.; Sain, M.; Cooper, P. A., 2005: Hygrothermal weathering of rice hull/HDPE composites under extreme climatic conditions. *Polymer Degradation and Stability*, 90 (3): 540-545.  
<https://doi.org/10.1016/j.polymdegradstab.2005.03.014>.
45. Wang, X.; Ren, H., 2008: Comparative study of the photo-discoloration of moso bamboo (*Phyllostachys pubescens* Mazel) and two wood species. *Applied Surface Science*, 254 (21): 7029-7034.  
<https://doi.org/10.1016/j.apsusc.2008.05.121>.
46. Williams, R. S., 2005: Weathering of wood, Handbook of wood chemistry and wood composites, 7: 139-185.
47. Winandy, J. E., 1988: Effects of treatment and redrying on mechanical properties of wood. Wood protection techniques and the use of treated wood in construction. Forest Products Research Society, 54-62.
48. Yalinkilic, M. K.; Gezer, E. D.; Takahashi, M.; Demirci, Z.; Ilhan, R.; Imamura, Y., 1999: Boron addition to non- or low-formaldehyde cross-linking reagents to enhance biological resistance and dimensional stability of wood. *Holz als Roh-und Werkstoff*, 57 (5): 351-357.  
<https://doi.org/10.1007/s001070050358>.
49. Yildiz, U. C.; Temiz, A.; Gezer, E. D.; Yildiz, S., 2004: Effects of the wood preservatives on mechanical properties of yellow pine (*Pinus sylvestris* L.) wood. *Building and Environment*, 39 (9): 1071-1075.  
<https://doi.org/10.1016/j.buildenv.2004.01.032>.
50. Yu, H. X.; Pan, X.; Xu, M. P.; Yang, W. M.; Wang, J.; Zhuang, X. W., 2018: Surface chemical changes analysis of UV-light irradiated Moso bamboo (*Phyllostachys pubescens* Mazel). *Royal Society Open Science*, 5 (6): 180110. <https://doi.org/10.1098/rsos.180110>.
51. Zhou, G., 2012: Extraction of preservative components from treated wood waste, PhD Thesis. Graduate Department of Forestry, University of Toronto.
52. \*\*\*ASTM G154, 2012: Standard practice for operating fluorescent ultraviolet (UV) lamp apparatus for exposure of nonmetallic materials.
53. \*\*\*ISO 13061-17, 2017: Physical and mechanical properties of wood – Test methods for small clear wood specimens, Part 17: Determination of ultimate stress in compression parallel to grain.
54. \*\*\*ISO 13061-3, 2014: Physical and mechanical properties of wood – Test methods for small clear wood specimens, Part 3: Determination of ultimate strength in static bending.
55. \*\*\*ISO 13061-4, 2014: Physical and mechanical properties of wood – Test methods for small clear wood specimens, Part 4: Determination of modulus of elasticity in static bending.

**Corresponding address:**

Assist. Prof. ELİF TOPALOĞLU, PhD

Department of Architecture and Urban Planning  
 Technical Sciences Vocational School  
 Giresun University  
 28200, Giresun, TURKEY  
 e-mail: elif.topaloglu@giresun.edu.tr

# Influence of Layered Structure of Composite Timber Floor Boards on Their Hardness

## Utjecaj strukture slojeva na tvrdoću višeslojnih podnih obloga

Original scientific paper • Izvorni znanstveni rad

Received – prispjelo: 12. 12. 2018.

Accepted – prihvaćeno: 20. 11. 2019.

UDK: 630\*812.731; 630\*832.284; 630\*833.18

<https://doi.org/10.5552/drvind.2019.1856>

**ABSTRACT** • The possibility of using composite elements of flooring pine veneers with knotholes for the production of supporting layers has been determined. This assessment was made on the basis of the Brinell hardness measurement of the face layer of five-layer composites with empty spots in their structure imitating knotholes of various diameters (10, 20 and 50 mm). The dependencies obtained from empirical determinations were supported by numerical analysis. It was found that it is possible to use veneers with defects (empty spots) with a diameter of up to 20 mm to produce composites of three and more layers of wood (counting from the face layer). The anatomical section of the exposed wood on the face (radial cross-section, tangential section) of the layered composite does not affect the obtained hardness values.

**Keywords:** veneer, composite, flooring material, knotholes, hardness

**SAŽETAK** • Ispitivanjem je potvrđena mogućnost uporabe furnira od borova drva s rupama od kvrga kao srednjeg sloja u proizvodnji višeslojnih podnih obloga. Ta je procjena napravljena na temelju mjerenja tvrdoće prema Brinellu gaznog sloja peteroslojne podne obloge s rupama različitih promjera (10, 20 i 50 mm) unutar strukture obloge koje simuliraju rupe od kvrga. Ovisnosti dobivene iz empirijskih rezultata potkrijepljene su računskom analizom. Utvrđeno je da je za proizvodnju podnih obloga od tri i više slojeva (brojeći od gaznog sloja) moguće upotrijebiti furnire s greškama (s neispunjenim rupama) promjera do 20 mm. Anatomski presjek izloženog drva na licu višeslojne podne obloge (radijalni i tangenti presjek) ne utječe na vrijednosti tvrdoće.

**Ključne riječi:** furnir, višeslojna podna obloga, rupe od kvrga, tvrdoća

### 1 INTRODUCTION

#### 1. UVOD

According to the European Federation of the Parquet Industry (FEP), 80.4 million m<sup>2</sup> of parquets were produced in Europe in 2016. 80 % of parquet production included multi-layered materials (excluding laminate floor panels) (FEP, 2018a). Poland maintains top position among producers (20.08 %), followed by

Sweden (16.99 %), Austria (14.02 %), and Germany (11.97 %). It should be noted that, according to FEP, wood flooring element can only be called “parquet” if its top layer is made of a solid wood with a minimum thickness of 2.5 mm (FEP, 2018b). Multi-layered structure increases the shape stability of flooring products and reduces the dimensional changes in relation to solid wood elements by up to 75 % (KEN’S YARD,

<sup>1</sup> Authors are researchers at Warsaw University of Life Sciences – SGGW, Faculty of Wood Technology, Warsaw, Poland.

<sup>1</sup> Autori su istraživači Sveučilišta prirodnih znanosti u Varšavi, Drvnotehnološki fakultet, Varšava, Poljska.

2018). Current trends in the development of the wood flooring industry include (Kozera, 2016): (1) optimisation of wood consumption (especially of high quality timber); (2) improvement in the quality of surface processing and joints; (3) development of easy, fast and permanent assembly technology of floor elements; (4) rich colouring and varied surface structure possibilities; (5) high durability and resistance of timber floor boards; (6) renovation possibilities.

In multi-layered floor materials, the support layer can be made of solid wood boards or peripherally cut veneers. In both cases, these raw materials are loaded with structural defects that decrease their strength parameters (Kretschmann, 2010). These defects can be eliminated or limited at the production stage. If veneers are used as load-bearing layers, the knots, especially loosed, are substantial defects. Their diameter can range from a few millimetres to several dozen. The negative influence of knots is manifested in the lowering of the tensile, bending and compression strength along the fibres and the modulus of elasticity (Phillips *et al.*, 1981). This influence is caused, among other things, by the discontinuity of stresses due to the different orientation of wood fibres. In laboratory tests, knots can be treated the same as holes (Bano, 2009, Guindos and Guaita, 2013). In a multi-layered composite, negative influence of knots or holes on strength parameters is smaller than in solid wood. This is related to their presence only in one layer of material. These spots are a potential source for the propagation of cracks during loading. The filling of knotholes requires additional technological steps in the manufacturing process of composite timber floor boards. Some layered materials (e.g. floor boards), tend to be less exposed to typical bending loads. In this case, the hardness of the material plays a greater role. Numerous studies presented in the literature indicate that hardness of wood and wood-based materials is affected by its density and moisture content (Kollman and Cote, 1968, Holmberg, 2000, Han *et al.*, 2007, Raymond, 2008, Franek *et al.*, 2009). The Brinell method (Schwab, 1990) gives the most reliable results of measuring surface hardness. It allows to determine the real variability of surface hardness in particular anatomical directions and differences in hardness on the width of growth rings, which is confirmed by the studies of Hirata *et al.* (2001). However, Doyle and Walker (1984) draw attention to the inaccuracy of measurement in the Brinell method resulting from the relaxation of the steel ball impression. Hardness of the layered system is influenced both by the outer (surface) layer and its support (load-bearing layers). There is very few information in literature related to the effect of support layers on the hardness of the surface layer in composites. However, it is to be expected that possible free spaces located under the surface layer may affect the reduction in its hardness. This phenomenon will depend both: on the free spaces area (holes) and its position in relation to the surface layer.

The aim of this work was to determine the effect of knotholes located in the load-bearing layers of a five-layer wood composite on its strength parameters and the Brinell hardness of the surface layer.

## 2 MATERIALS AND METHODS

### 2. MATERIJALI I METODE

The research was carried out using five-layer timber floor boards with a nominal thickness of 15 mm. The surface layer of the composite was sawn material - oak boards (*Quercus robur* L.). Four other layers (load-bearing layers) were made of circumferentially cut pine veneer (*Pinus sylvestris* L.). The individual layers were arranged to each other in a cross-shaped manner, providing an angle of 90 degrees between the fibres of the next layer. Oak boards had a nominal thickness of 3 mm and a moisture content of approx. 5 %. Two variants of surface layer material were used during testing, different in terms of the anatomical cross-section of wood on the wide surface of planks: radial and tangential. Pine veneers had a nominal thickness of 3.2 mm and a moisture content of approx. 5 %. The thickness of the veneer resulted from the desire to limit the number of the load-bearing layers and thus the number of glue lines, while maintaining the final thickness of the entire floor panel. 3 mm thick veneer is used industrially for the production of LVL or plywood. Materials for all layers of floor boards were produced under industrial conditions with the preservation of standard technological conditions. An adhesive based on an industrial urea-formaldehyde resin (UF) was applied to consecutive layers. An industrial hardener was added to the resin in the amount of 5 % by weight, enabling the composite pressing process to be carried out within 120 s at 120 °C. The composites were produced with the use of laboratory hydraulic press at a unit pressure of 1.5 MPa.

The effect of knotholes of various diameters located in selected layers of the composite on its hardness was determined.

The following tests were carried out:

- hardness of the composite according to EN 1534:2011 Wooden floor - Determination of resistance to indentation (Brinell method) - Test method;
- density profile to determine density distribution in individual layers of the composite.

#### 2.1 Brinell hardness test

##### 2.1. Tvrdóća prema Brinellu

For the testing, samples with dimensions of 330 mm × 150 mm (length × width) and a thickness resulting from the combination of a surface layer (3.0 mm) and four veneers (load-bearing layers – 4 × 3.2 mm) were used (Figure 1). All layers were glued together with the direction of the grain in adjacent layers at right angles. The grain of the surface layer was parallel to the long edge of the panel. In the supporting layers (second and third, respectively), round gaps were prepared with diameters of: 10 mm, 20 mm and 50 mm (at one panel two gaps of each diameter) simulating knotholes. Location of gaps resulted from guidelines of the standard EN 1534:2011, which defines minimum distances between hardness measurement points. Control (reference) samples without round gaps were also prepared and tested.

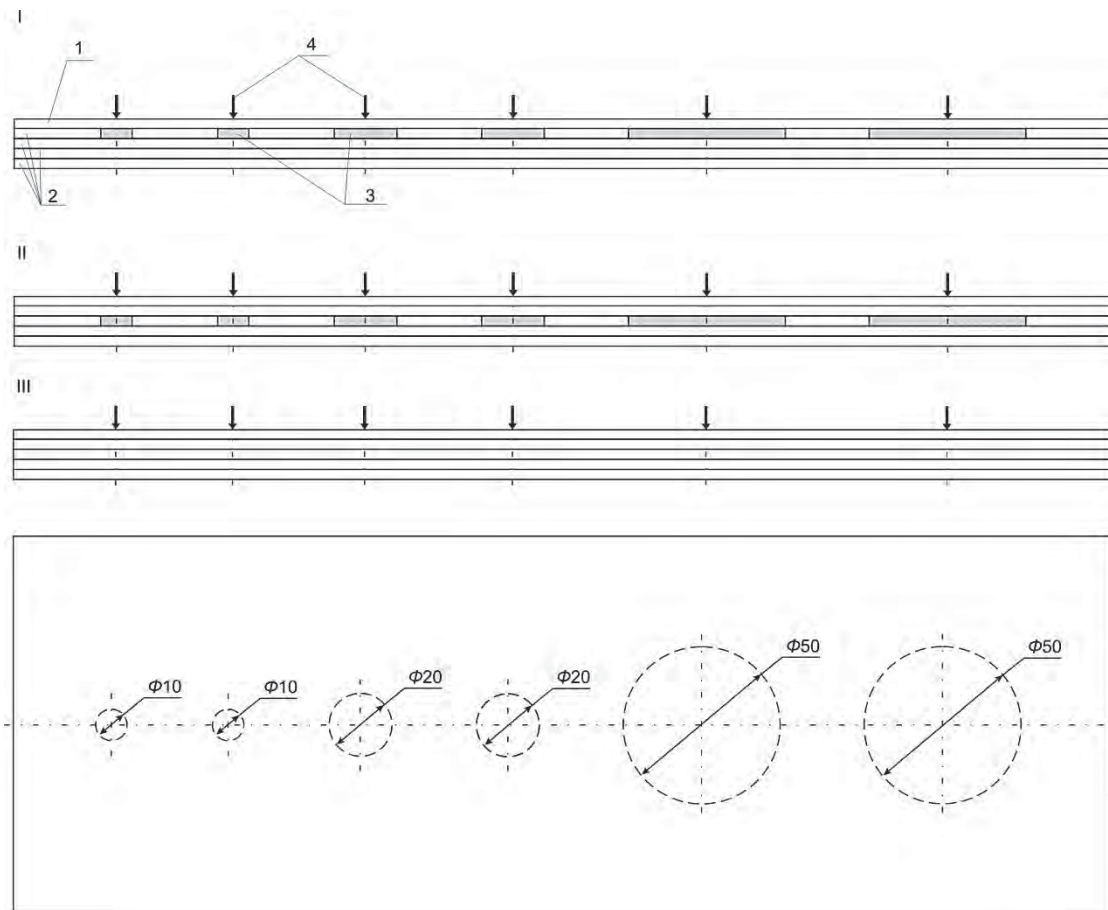

**Figure 1** Samples for Brinell hardness test (I, II – variants of samples with round gaps simulating knotholes within the first and second sublayer, III – control variant, 1 – surface layer – oak wood, 2 – load-bearing layers – pine wood, 3 – round gaps, 4 – hardness measurement points on the surface layer)

**Slika 1.** Uzorci za mjerenje tvrdoće prema Brinellu (I, II – varijante uzoraka s rupama koje simuliraju rupe od kvrga u prvome i drugom podsloju, III – kontrolna varijanta, 1 – gazni sloj: drvo hrasta, 2 – središnji slojevi – drvo bora, 3 – rupe, 4 – mjesta za mjerenje tvrdoće na gaznom sloju)

Brinell hardness test was carried out with the use of CV-3000LDB equipment (CV Instruments, Bowers Group) in accordance with EN 1534:2011 standard. During testing a predetermined load of 1000 N was applied to a carbide ball of 10 mm diameter. It was held for a 20 second period and then removed. The resulting impression was measured with a microscope across two diameters (at right angles to each other) and these results were averaged. For each variant of samples and each grain layout of the surface layer (radial and tangential), 12 impressions were made.

## 2.2 Density profile determination

### 2.2. Određivanje profila gustoće

The study was conducted with the use of DAX GreCon Density Analyzer. Density distribution was determined on samples with dimensions: 50 mm × 50 mm × 15 mm. The distance between adjacent measurement points was 0.02 mm, and the measurement speed was 0.05 mm/s.

## 2.3 Numerical analysis

### 2.3. Računska analiza

To confirm possible dependencies, a numerical analysis was performed in SolidWorks Simulation environment. A model referring to the Brinell hardness

test according to EN 1534: 2011 was created. The tested material was five layered composite timber floor board with oak surface layer (3 mm thick) and 4 other layers made of pine wood (4 mm × 3.2 mm thick). The material properties used for FE-model are summarised in Table 1. The anisotropy of wood-based material was modelled using orthotropic properties. A static model with linear elastic material properties was used to study the stress distribution. The elastic constants adopted in the FEM analysis were taken from previous experimental work on small clear specimens of pine wood (Burawska, 2016). Material parameters for oak wood were selected on the basis of reports from literature (Kollmann and Cote, 1968; Krzysik, 1975).

The individual layers of the composite were arranged to each other in a cross-shaped manner and a “bonded” contact between them was established. Then, the composite was subjected to a load of 1000 N, applied on the surface of a circle with a diameter of 10 mm. Then, in load-bearing layers (second or third), round gaps with diameters of 10 mm, 20 mm, 30 mm, 40 mm and 50 mm were made successively. The axes of round gaps were in the axis of the applied load. A solid standard mesh with a global size of approximately 1mm was used, compacted in the vicinity of gaps

**Table 1** Material parameters of oak and pine wood – based on reports from literature (Kollmann and Cote, 1968; Krzysik, 1975)**Tablica 1.** Svojstva drva hrasta i drva bora na temelju podataka iz literature (Kollmann and Cote, 1968.; Krzysik, 1975.)

	$E_1$ N/mm <sup>2</sup>	$E_2$ N/mm <sup>2</sup>	$E_3$ N/mm <sup>2</sup>	$\mu_{12}$	$\mu_{13}$	$\mu_{23}$	$G_{12}$ N/mm <sup>2</sup>	$G_{13}$ N/mm <sup>2</sup>	$G_{23}$ N/mm <sup>2</sup>
Oak / Drvo hrasta	13000	2190	990	0.5	0.43	0.62	1320	400	780
Pine / Drvo bora	15000	1200	750	0.42	0.37	0.47	1070	107	1007

and applied force. The total number of elements in each analysed computing case was about 3,900,000, and the number of nodes about 605,000, respectively. The default failure criterion was related to the compressive strength across fibres of the five-layer composite overrun (6 N/mm<sup>2</sup>).

### 3 RESULTS AND DISCUSSION

#### 3. REZULTATI I RASPRAVA

Hardness of composite timber floor boards is an important utility feature, strictly dependent on its density (Hirata *et al.*, 2001), and in particular on the density of the surface layer. Tested layered materials were characterised by an average density of 618 kg/m<sup>3</sup>; however, they differed in their thickness (Figure 2).

Surface layer of the composite made of oak boards (*Quercus robur* L.) had an average density of around 680 kg/m<sup>3</sup>. The load-bearing layers made of pine veneer (*Pinus sylvestris* L.) were characterised by a density in the range of 411 - 778 kg/m<sup>3</sup>, while welds reached a density above 1000 kg/m<sup>3</sup>. During the gluing process, partial compression of pine wood occurred, evident in higher density of layers 1 and 5 (compared to layer 3). Additionally, adhesive penetrated the voids and irregularities in the surface area of individual veneers and hardened, which also influenced the material density in a weld zone (Lou *et al.*, 2015).

The results of the Brinell hardness of the surface layer obtained during tests are presented in Table 2.

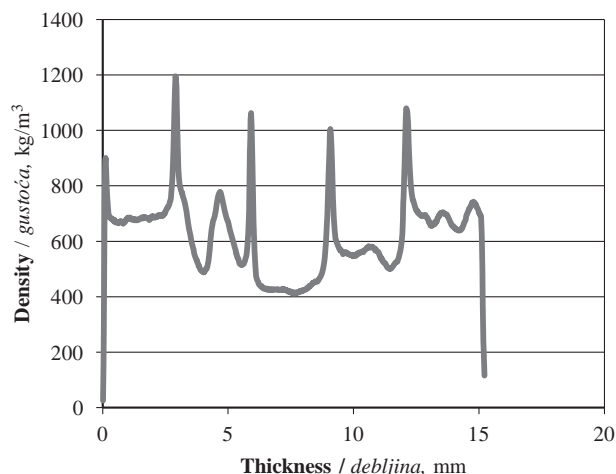
**Figure 2** Exemplary density profile of layered composite – variant III (control)**Slika 2.** Primjer profila gustoće višeslojne podne obloge – varijanta III (kontrola)

Multi-layered composites without any round gaps in their structure were characterised by an average Brinell hardness of the surface layer of 45.9 N/mm<sup>2</sup>.

Similar hardness results were reported regarding flooring materials made of cork oak (*Quercus suber* L.) – around 56 N/mm<sup>2</sup> and Portuguese oak (*Quercus faginea* L.) – around 50 N/mm<sup>2</sup> (Knapic *et al.*, 2012). Tudor *et al.* (2018) stated that the hardness of parquets with a surface layer made of bark with a density of 700 kg/m<sup>3</sup> is around 39 N/mm<sup>2</sup>. Knapic *et al.* (2012), in

**Table 2** Results of Brinell hardness of tested variants of layered wood composites**Tablica 2.** Rezultati tvrdoće prema Brinellu ispitivanih varijanti višeslojnih podnih obloga

Anatomical cross-section of surface layer Anatomski presjek gaznog sloja	Brinell hardness Tvrdoća prema Brinellu		Control no round gaps (variant III) Kontrola bez rupa (varijanta III)	Diameter of round gap located in layer 2 (variant I), mm			Diameter of round gap located in layer 3 (variant II), mm		
				Promjer rupa u drugom sloju (varijanta I), mm			Promjer rupa u trećem sloju (varijanta II), mm		
				10	20	50	10	20	50
Radial radijalni presjek	average	N/mm <sup>2</sup>	45.9 <sup>b,A</sup>	22.2 <sup>a</sup>	-	-	39.5 <sup>b,A</sup>	43.3 <sup>A</sup>	39.3 <sup>A</sup>
	max		62.4	33.8	-	-	49.9	56.3	50.8
	min		37.9	14.8	-	-	32.3	31.0	29.5
	stand. dev.		8.8	6.2	-	-	5.5	8.3	7.7
	COV		%	19.1	28	-	-	13.9	19.1
Tangential tangenti presjek	average	N/mm <sup>2</sup>	44.5 <sup>b,A</sup>	21.6 <sup>a</sup>	-	-	36.0 <sup>b,A</sup>	38.6 <sup>A</sup>	45.7 <sup>A</sup>
	max		63.4	28.8	-	-	59.5	56.6	61.1
	min		34.2	14.0	-	-	25.5	26.1	36.5
	stand. dev.		9.5	6.2	-	-	8.7	9.2	9.5
	COV		%	21.3	29.0	-	-	24.2	23.9

COV – coefficient of variation / koeficijent varijacije

\*a, b – homogeneous groups for the analysis of the impact of round gaps (diameter 10 mm) location / \*a, b – homogene grupe za analizu utjecaja položaja rupa (promjer 10 mm)

\*\*A – homogeneous groups for the analysis of the impact of round gaps (diameter 10 mm, 20 mm, 50 mm) located in layer 3 / \*\*A – homogene grupe za analizu utjecaja rupa (promjer 10, 20 i 50 mm) smještenih u trećem sloju



**Figure 3** Sample indentations in the surface of layered composite samples with round gaps simulating knotholes located in layer 2 (variant I) after hardness testing: a) control sample, b) sample with a 10 mm round gap, c) sample with a 20 mm round gap, d) sample with a 50 mm round gap

**Slika 3.** Udubljenje na površini uzoraka višeslojne podne obloge s rupama u drugom sloju koje simuliraju rupe od kvruga (varijanta I) nakon ispitivanja tvrdoće: a) kontrolni uzorak, b) uzorak s rupom promjera 10 mm, c) uzorak s rupom promjera 20 mm, d) uzorak s rupom promjera 50 mm

turn, stated that softwood materials usually have much lower Brinell hardness values (in the range of 13-25 N/mm<sup>2</sup>). With respect to conducted tests, it can be generally stated that unfilled round gaps located in the composite load-bearing layers (second or third, respectively), depending on their location and diameter, significantly affect its hardness.

The arrangement of round gaps simulating knots with diameters of 20 and 50 mm in layer 2 caused deflection of the surface layer as well as cracks (Figure 3). That is why the obtained results could be inconclusive. In the case of 10 mm diameter round gaps, a statistically significant decrease in the hardness of the composite was noted, reaching over 50 % of the initial hardness (without a gap in the supporting layer).

A variance analysis showed a significant effect of the layer containing round gaps (Table 3). Round gaps located in layer 3 of the composite (variant II) did not significantly change its hardness with respect to control (Table 4). It is worth noting that virtually in all tested variants (both with unfilled gaps in layer 3 and

control), similar values of variability coefficients were recorded.

Despite the lack of a statistically significant decrease in Brinell hardness values for all tested cases of variant II (in relation to control), attention should be paid to the high local elasticity of wood composites, especially when round gaps of 50 mm diameter were placed in layer 3. In this case, during hardness test, a visible deflection of the composite surface layer occurred as a result of lack of the support (free space). However, noticeable deflection of material did not cause visible damage (cracks) on the surface of the oak planks, but it could lead to the formation of hard-to-detect microcracks, which ultimately weakened the examined cross-section. The deflection of surface layer during the test could also have influenced the superficial gain in hardness value, especially in case of tangential anatomical cross-section of surface layer. As a result of the materials deflection, ball indicator could give impression of a smaller diameter on its oak surface layer. All obtained hardness values exceeded 10 N/mm<sup>2</sup>, which is the mini-

**Table 3** ANOVA table – place of empty spot and cross-section of top layer

**Tablica 3.** ANOVA tablica – položaj rupa i presjek gaznog sloja

Source of variance <i>Izvor odstupanja</i>	SS	Df	MS	F	p	P (%)
Anatomical cross-section of surface layer (CS) <i>anatomski presjek gaznog sloja (CS)</i>	44.01	1	44.01	0.75	0.389	0.62
Layer with round gap (LRG) / <i>sloj s rupama (LRG)</i>	4157.02	2	2078.51	35.66	0.000	59.21
CS x LRG	21.98	2	10.99	0.19	0.829	0.31
Error / <i>pogreška</i>	2797.79	48	58.29			39.85

SS – sum of squared deviations from the mean value, Df – degrees of freedom, MS – mean square ( $MS = SS/Df$ ),

F – test value, p – probability of error, X – percentage effect of factors on the analysed parameter / SS – zbroj kvadratnih odstupanja od srednje vrijednosti, Df – stupnjevi slobode, MS – srednji kvadrat ( $MS = SS/Df$ ), F – vrijednost ispitivanja, p – vjerojatnost pogreške, X – postotni utjecaj čimbenika na analizirani parametar

**Table 4** ANOVA table – unfilled round gap in layer 3 of the composite with respect to control

**Tablica 4.** ANOVA tablica – neispunjena rupa u trećem sloju višeslojne podne obloge s obzirom na kontrolni uzorak

Source of variance <i>Izvor odstupanja</i>	SS	Df	MS	F	p	P (%)
Anatomical cross-section of surface layer (CS) <i>anatomski presjek gaznog sloja (CS)</i>	12.30	1	12.30	0.18	0.676	0.21
Layer with round gap (LRG) / <i>sloj s rupama (LRG)</i>	559.00	3	186.30	2.67	0.054	9.69
CS x LRG	305.30	3	101.80	1.46	0.234	5.29
Error / <i>pogreška</i>	4892.10	70	69.90			84.80

SS – sum of squared deviations from the mean value, Df – degrees of freedom, MS – mean square ( $MS = SS/Df$ ),

F – test value, p – probability of error, X – percentage effect of factors on the analysed parameter / SS – zbroj kvadratnih odstupanja od srednje vrijednosti, Df – stupnjevi slobode, MS – srednji kvadrat ( $MS = SS/Df$ ), F – vrijednost ispitivanja, p – vjerojatnost pogreške, X – postotni utjecaj čimbenika na analizirani parametar



**Table 5** Hardness requirements for different flooring applications (EN 14354:2017)

**Tablica 5.** Zahtijevana tvrdoća drvenih podnih obloga s obzirom na mjesto uporabe (EN 14354:2017)

Level of use / Stupanj opterećenja		Hardness / Tvrdoća, N/mm <sup>2</sup>
Domestic / Kućna uporaba	Moderate / umjeren	≥ 10
	General / normalan	≥ 20
	Heavy / velik	≥ 20
Commercial / Javna uporaba	Moderate / umjeren	≥ 30
	General / normalan	≥ 40
	Heavy / velik	≥ 40

imum acceptable value for wooden floors in several European standards. The EN 14354:2017 standard specifies hardness reference values for floor materials depending on various end uses (Table 5).

Based on presented data (Table 2 and 5), it could be noticed that all tested multi-layered composites can be used in all domestic applications. In case when gaps are located in layer 3, tested composites can also be used in commercial applications with moderate traffic.

Tests showed that there is no influence of an anatomical cross-section of surface layer (radial, tangential) on Brinell hardness, which was also confirmed by

statistical variance analysis (Tables 3 and 4). This is also consistent with the literature (e.g. Kretschmann, 2010).

Table 6 presents the results of the numerical analysis carried out for individual variants of wood composites. Minimum and maximum values of stresses were read in the vicinity of the applied force and round gap simulating the knot. Figures 4, 5 and 6 show maps of normal stresses occurred in case of 1000 N loading ( $\sigma_x$ ,  $\sigma_y$  and  $\sigma_z$ ).

The control variant (without gaps) was characterised by the smallest values of normal stresses in all di-

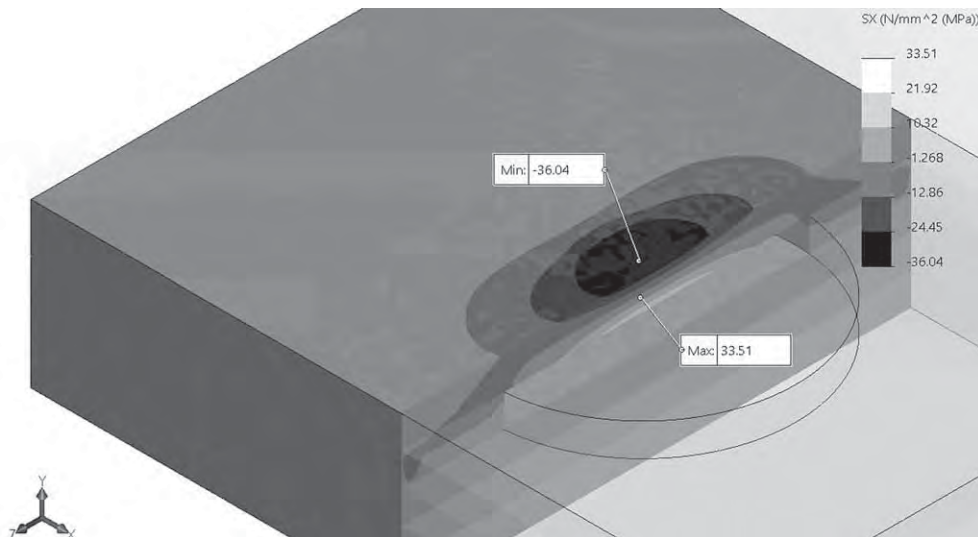

**Figure 4** Map of normal stress  $\sigma_x$  (1000 N load, round gap diameter 30 mm)

**Slika 4.** Prikaz normalnog naprezanja  $\sigma_x$  (opterećenje 1000 N, rupa promjera 30 mm)

**Table 6** Results of numerical analysis of wood composite variants

**Tablica 6.** Rezultati računске analize varijanti višeslojnih podnih obloga

		$\sigma_x$ max	$\sigma_x$ min	$\sigma_y$ max	$\sigma_y$ min	$\sigma_z$ max	$\sigma_z$ min	Deflection, mm Progib, mm
		N/mm <sup>2</sup>						
Control (variant III) Kontrola (varijanta III)		2.6	-7.1	1.7	-14.7	6.7	-26.7	-0.05
Diameter of round gap located in layer 2 (variant I) Promjer rupe u drugom sloju (varijanta I)	10 mm	11.1	-21.7	7.5	-23.7	61.3	-75.6	-0.11
	20 mm	25.1	-28.8	4.7	-35.8	122.0	-138.0	-0.31
	30 mm	33.5	-36.0	6.6	-41.1	157.0	-176.0	-0.58
Diameter of round gap located in layer 3 (variant II) Promjer rupe u trećem sloju (varijanta II)	40 mm	42.4	-44.3	27.8	-49.7	189.0	-211.0	-1.00
	50 mm	43.1	-49.0	20.7	-42.0	192.0	-229.0	-1.38
	10 mm	25.2	-11.4	1.7	-14.8	15.7	-33.8	-0.06
Diameter of round gap located in layer 3 (variant II) Promjer rupe u trećem sloju (varijanta II)	20 mm	38.6	-27.0	1.8	-14.8	18.0	-51.0	-0.11
	30 mm	51.1	-32.7	2.6	-14.8	25.6	-62.5	-0.18
	40 mm	62.4	-41.5	5.7	-15.0	33.3	-71.1	-0.27
	50 mm	40.8	-77.9	5.9	-15.7	68.4	-73.5	-0.36

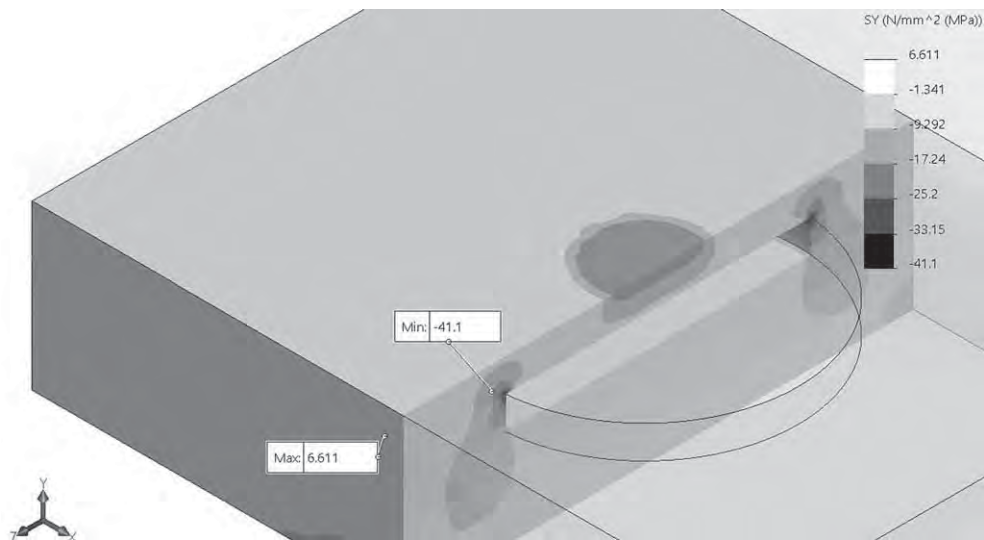

**Figure 5** Map of normal stress  $\sigma_y$  (1000 N load, round gap diameter 30 mm)  
**Slika 5.** Prikaz normalnog naprezanja  $\sigma_y$  (opterećenje 1000 N, rupa promjera 30 mm)

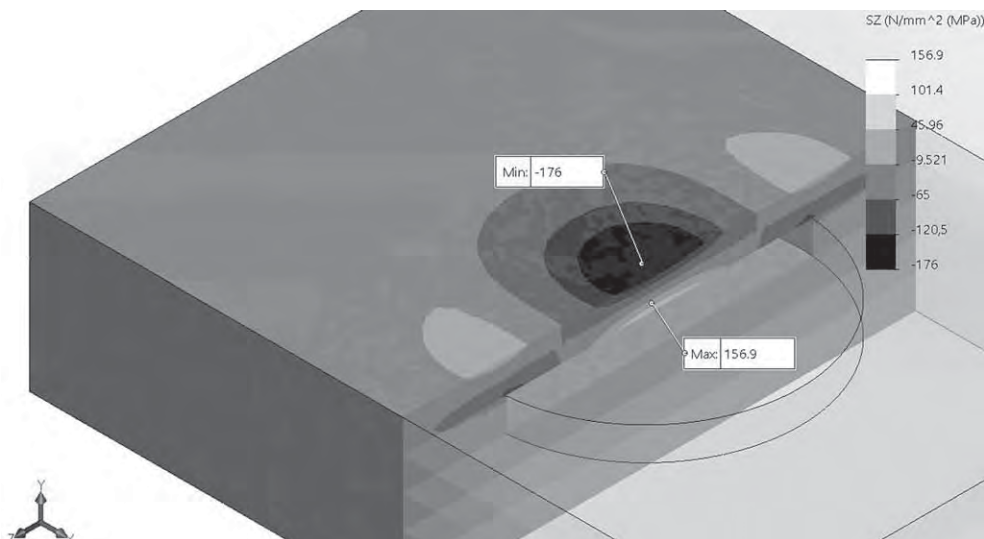

**Figure 6** Map of normal stress  $\sigma_z$  (1000 N load, round gap diameter 30 mm)  
**Slika 6.** Prikaz normalnog naprezanja  $\sigma_z$  (opterećenje 1000 N, rupa promjera 30 mm)

rections ( $\sigma_x$ ,  $\sigma_y$  and  $\sigma_z$ ) in relation to composites with material defects in their layout. With the increase in the diameter of round gaps simulating defect (both in layer 2 and 3), the values of deflections increase, as well as individual stress components in most cases. Round gaps located in layer 3 of the composite (variant II) affect the values of stresses in respective layers to a very limited extent. It should be noted that there is no impact of gaps of any diameter located in layer 3 on stress values  $\sigma_y$  (in the load plane). In the case of gaps located in layer 2, the impact of the hole, even with a diameter of 10 mm, is manifested by a significant increase in all stress components as well as deflection, resulting from the lack of direct material support within the defect.

#### 4 CONCLUSIONS 4. ZAKLJUČAK

It is possible to use veneers with defects (unfilled gaps) with a diameter of up to 20 mm as an internal

layer (3rd or subsequent, counting from the surface layer) of multi-layered composite.

The Brinell hardness, determined on the longitudinal sections of oak wood as surface layer of layered composite, is around 45.2 N/mm<sup>2</sup>. When using veneer with defect (round unfilled gap of diameter up to 20 mm) as a layer 3 or subsequent, hardness values of surface layer are in the range of 36.0 - 43.3 N/mm<sup>2</sup>.

The anatomical cross-section of the surface layer (radial, tangential) does not affect the hardness values of multi-layered composite.

#### Acknowledgements – Zahvala

The authors are grateful for the support of the National Centre for Research and Development, Poland, under “Environment, agriculture and forestry” – BIOSTRATEG strategic R&D programme, agreement No. BIOSTRATEG2/298950/1/NCBR/2016.

## 5 REFERENCES

### 5. LITERATURA

1. Bano, V., 2009: Numerical analysis of wood strength loss due to presence of knots, PhD thesis. Polytechnic University of Madrid. Madrid.
2. Burawska, I., 2015: Local reinforcement of pine structural timber (*Pinus sylvestris* L.), PhD thesis. Warsaw University of Life Sciences – SGGW.
3. Doyle, J.; Walker, J. C. F., 1984: Indentation hardness of wood. *Wood Fibre Science*, 17 (3): 369-376.
4. Franek, F.; Badisch, E.; Kirchgaßner, M., 2009: Advanced methods for characterisation of abrasion/erosion resistance of wear protection materials. *FME Transactions*, 2 (37): 61-70.
5. Guindos, P.; Guaita, M., 2013: A three-dimensional wood material model to simulate the behavior of wood with any type of knot at the macro-scale. *Wood Science and Technology*, 47: 585-599. <http://dx.doi.org/10.1007/s00226-012-0517-4>.
6. Han, G.; Wu, Q.; Lu, J. Z., 2007: The influence of fines content and panel density on properties of mixed hardwood oriented strand boards. *Wood Fiber Science*, 39 (1): 2-15.
7. Hirata, S.; Ohta, M.; Honma, Y., 2001: Hardness distribution on wood surface. *Journal of Wood Science*, 47(1): 1-7. <http://dx.doi.org/10.1007/BF00776637>.
8. Holmberg, H., 2000: Influence of grain angle on Brinell hardness of Scots pine (*Pinus sylvestris* L.), *Holz als Roh- und Werkstoff*, 58 (1/2): 91-95. <http://dx.doi.org/10.1007/s001070050392>.
9. Knapic, S.; Machado, J. S.; Pereira, H., 2012: Properties of cork oak wood related to solid wood flooring performance. *Construction and Building Materials*, 30: 569-573. <http://dx.doi.org/10.1016/j.conbuildmat.2011.11.014>.
10. Kollmann, F. F. P.; Cote, W. A., 1968: Principles of wood science and technology. *Solid Wood*. Springer-Verlag Berlin Heidelberg, New York, pp. 592.
11. Kozera, D., 2016: Innovation in the wood flooring production. In: Proceedings of The National scientific and technical conference: Innovation in the Polish wood sector – strengths and weaknesses, Warsaw, May 12, 2016, p.p. 37-40 (in Polish).
12. Kretschmann, D. E., 2010: Mechanical properties of wood. In: *Wood handbook – Wood as an engineering material*. Centennial edition. General technical report FPL; GTR-190, Ross, R. J. (ed.). Madison, Wisconsin: U.S. Department of Agriculture, Forest Service, Forest Products Laboratory, pp. 100-145.
13. Krzysik, F., 1975: *Wood science*. Państwowe Wydawnictwo Naukowe. Warsaw, p.p. 663 (in Polish).
14. Luo, J.; Luo, J.; Gao, Q.; Li, J., 2015: Effects of heat treatment on wet shear strength of plywood bonded with soybean meal-based adhesive. *Industrial Crops and Products*, 63: 281-286. <http://dx.doi.org/10.1016/j.indcrop.2014.09.054>.
15. Phillips, G. E.; Bodig, J.; Goodman, J. R., 1981: Flow grain analogy. *Wood Science*, 14: 55-64.
16. Raymond, C., 2008: Influence of wood density and fibre length on properties of medium density fibreboard manufactured from *Pinus radiata*. *Appita Journal: Journal of the Technical Association of the Australian and New Zealand Pulp and Paper Industry*, 60 (3): 204-208.
17. Schwab, E., 1990: Die Härte von Laubhölzern für die Parkettherstellung [*The hardness of hardwoods for parquet production*]. *Holz als Roh- und Werkstoff*, 48 (2): 47-51 (in German). <https://doi.org/10.1007/BF02610703>.
18. Tudor, E. M.; Barbu, M. C.; Petutschnigg, A.; Réh, R., 2018: Added-value for wood bark as a coating layer for flooring tiles. *Journal of Cleaner Production*, 170: 1354-1360. <http://dx.doi.org/10.1016/j.jclepro.2017.09.156>.
19. \*\*\*EN 14354, 2017: Wood-based panels – wood veneer floor coverings. CEN, European Committee for Standardization, Brussels, Belgium, p.p. 51.
20. \*\*\*EN 1534, 2010: Wood flooring. Determination of resistance to indentation. Test method. CEN, European Committee for Standardization, Brussels, Belgium, pp. 9.
21. \*\*\*FEP, 2018a: The Parquet Industry. Facing the future with optimism (online). [http://www.parquet.net/files/2017\\_-\\_FEP\\_-\\_Market\\_-\\_June\\_PR.pdf](http://www.parquet.net/files/2017_-_FEP_-_Market_-_June_PR.pdf) (Accessed May 17, 2018).
22. \*\*\*FEP, 2018b: The Parquet Industry. Parquet (online). [http://www.parquet.net/files/2017\\_-\\_FEP\\_-\\_Parquet.pdf](http://www.parquet.net/files/2017_-_FEP_-_Parquet.pdf) (Accessed May 17, 2018).
23. \*\*\*KEN'S YARD, 2018: Why is engineered wood flooring better than solid wood? (online). <http://www.kensyard.co.uk/product-guides/why-is-engineered-flooring-better-than-solid/> (Accessed May 28, 2018).

### Corresponding address:

PIOTR BORYSIUK

Warsaw University of Life Sciences – SGGW  
 Faculty of Wood Technology  
 Nowoursynowska Str. 159, 02-776 Warsaw, POLAND  
 e-mail: piotr\_borysiuk@sggw.pl

# Consumer Perception of Environmentally Sustainable Products of Slovak Wood Processing Enterprises

## Korisnička percepcija ekološki održivih proizvoda slovačkih drvoprerađivačkih poduzeća

### Original scientific paper • Izvorni znanstveni rad

Received – prispjelo: 5. 4. 2019.

Accepted – prihvaćeno: 20. 11. 2019.

UDK: 502; 630\*7

<https://doi.org/10.5552/drvind.2019.1922>

**ABSTRACT** • To provide environmentally sustainable development of a wood processing enterprise, it is necessary to implement environmentally sustainable products. The study focuses on identifying the factors of consumer perception of environmentally sustainable wood processing products and recommends how to ensure such product development. The main objective of the research was to survey the perception of environmentally sustainable wood processing products by consumers and to identify the factors that consumers take into account when making purchasing decisions. The survey was conducted by the method of questionnaire, addressing 754 adult inhabitants of Slovakia. The results revealed that the most frequently indicated reason for purchasing environmentally sustainable wood processing products was that they had a positive impact on health. The most commonly identified reason why consumers do not buy these products was their high price. The survey results should help understand the needs of consumers with regard to the environmental aspects of wood processing products, and thus ensure better satisfaction of their environmental needs.

**Keywords:** environment; sustainable development; environmental sustainable wood processing product; consumer; purchase; wood processing enterprise

**SAŽETAK** • Kako bi se osigurao održivi razvoj drvoprerađivačkog poduzeća, u proizvodnju je potrebno uvesti ekološki održive proizvode. U fokusu istraživanja ovog rada bilo je identificiranje čimbenika korisničkih percepcija o ekološki održivim drvnim proizvodima i davanje preporuka za osiguranje razvoja takvih proizvoda. Glavni je cilj istraživanja bio metodom anketiranja korisnika utvrditi što oni razumijevaju pod pojmom ekološki održivih

<sup>1</sup> Author is associate professor at Matej Bel University, Faculty of Economics, Banská Bystrica, Slovakia. <sup>2</sup> Author is associate professor at Technical University in Zvolen, Faculty of Wood Science and Technology, Zvolen, Slovakia. <sup>3</sup> Author is associate professor at Matej Bel University, Faculty of Economics, Banská Bystrica, Slovakia. <sup>4</sup> Author is professor at University of Zagreb, Faculty of Forestry, Zagreb, Croatia. <sup>5</sup> Author is researcher at Matej Bel University, Faculty of Economics, Banská Bystrica, Slovakia.

<sup>1</sup> Autor je izvanredni profesor Sveučilišta Matej Bel, Ekonomski fakultet, Banska Bystrica, Slovačka. <sup>2</sup> Autor je izvanredni profesor Tehničkog sveučilišta u Zvolenu, Fakultet drvene znanosti i tehnologije, Zvolen, Slovačka. <sup>3</sup> Autor je izvanredni profesor Sveučilišta Matej Bel, Ekonomski fakultet, Banska Bystrica, Slovačka. <sup>4</sup> Autor je profesor Sveučilišta u Zagrebu, Šumarski fakultet, Zagreb, Hrvatska. <sup>5</sup> Autor je istraživač Sveučilišta Matej Bel, Ekonomski fakultet, Banska Bystrica, Slovačka.

drvnih proizvoda i utvrđivanje onih čimbenika koje kupci uzimaju u obzir pri donošenju odluke o kupnji. Anketa je provedena metodom upitnika, pri čemu su anketirane 754 odrasle osobe s boravištem u Slovačkoj. Rezultati istraživanja pokazali su da je najčešći razlog za kupnju ekološki održivih drvnih proizvoda to što oni pozitivno utječu na zdravlje. Ono što su ispitanici najčešće naveli kao razlog da ne kupe određeni proizvod jest njegova visoka cijena. Rezultati istraživanja trebali bi pomoći u razumijevanju potreba korisnika drvnih proizvoda s obzirom na ekološki aspekt proizvoda, a time pridonijeti i boljem zadovoljavanju njihovih ekološki motiviranih potreba.

**Ključne riječi:** okoliš, održivi razvoj, ekološki održivi drvoprerađivački proizvodi, korisnik, kupnja, drvoprerađivačko poduzeće

## 1 INTRODUCTION

### 1. UVOD

Wood is a renewable, universal, and generally available and accessible raw material that can be used to make virtually anything. Wood can be easily processed, possesses outstanding construction qualities, and is hard, firm, and flexible. Besides this, wood has good thermal properties, which is a result of energy and heat radiation from the material. It is an attractive, natural, and noble material, which represents the most perspective ecological material of the future. It offers ideal opportunities for zero-waste processing, while being recyclable and environmentally friendly in its formation and disposal (Sedliačiková *et al.*, 2016). At present, wood-processing industry in Slovakia makes products in a total value of €3 billion, and provides approximately 40,000 working positions. It thus represents an important factor for sustainable employment in rural areas (Hajduchová *et al.*, 2016).

The objective of ecological innovations is to achieve demonstrable progress towards the goal of sustainable development, by reducing environmental impacts or achieving greater efficiency and responsibility for the use of natural resources and energy. Areas that have the greatest potential for ecological innovations include the wood processing and energy sectors, transportation, waste management, and the information and communication technologies. Radical eco-innovations then include more product functionality, raw material efficiency, recyclability, zero waste in the end of the product life cycle, and the use of local raw materials to eliminate the transport of materials (Zhou and Minshall, 2014).

These and many other features can define an environmentally sustainable product (ESP) as one of eco-innovations. In addition to other aspects, the ESP is a result of sustainable business activities, where there is an equally strong need to introduce eco-technologies and eco-innovations. Such change is then one of the steps of an enterprise to gradually contribute to the goal of sustainable development. According to Benčíková and Poliak (2016), such progress can be achieved through ecological innovations, however, not only in the environmental sector. It is necessary to adopt a systematic approach and implement environmental insight into sustainable development policies.

Introducing radical innovations at any stage of the product life cycle, or resolving environmental issues in different areas, such as choosing the right material, efficient energy consumption and pollution pre-

vention, are ways for an enterprise to make its products sustainable, while achieving their higher competitiveness (Dangelico and Pujari, 2010). Hosseinpour *et al.* (2015), and Malá *et al.* (2017a) state that ESP is a product that reduces the burden on the environment in terms of raw material, energy, emission quantity, waste water, solid waste, and other environmental damage, during the whole product lifetime cycle. An environmentally sustainable and innovative product is characterized by taking into account the possibilities of recyclability and disposal during its life cycle, as well as the possibility of using materials that are recycled or recyclable, that are non-toxic and do not pollute the environment, or have a lower impact (Malá, 2017b). According to Herchen (2007), Dubihlela and Ngxukumeshe (2016), for enterprises, an ESP is defined in four areas: biodegradable, renewable, recyclable, and environmentally safe. Shamraiz *et al.* (2018) state that, if there is interest in making the product more sustainable and hence environmental, it is necessary to take care of the design of the product with primary concern for product durability, repair, modernization, dismantling and production from sustainable materials. Paluš *et al.* (2018) state that the significance of wood and paper products originating from certified sustainable sources has been increasing worldwide during the last two decades along with interest and concern for global sustainability issues. Forest certification is a voluntary verification tool that has been gaining importance not only as an independent verification tool in the wood processing industry but also as an influencer in private and public purchasing policies and as a component of emerging wood harvesting and trade legality schemes.

Besides acting in a socially responsible way, attempting to improve the image and brand name of the enterprise, trying to reduce and save costs, as well as due to an effort to maintain environmental responsibility, enterprises are committed to offer an ESP. That is why there is an increase in the consumers in the market who implement their interest in the environment not only into their everyday life but also in terms of making purchasing decisions. However, this is influenced by several factors. Statistics show that almost 50 % of consumers are interested in the environmental criteria of products and services (Chen *et al.*, 2018). This change in consumer perception started more than a decade ago.

The Boston Consulting Group conducted a global survey in 2009 to assess ecological attitudes and purchase behavior. The research sample was made up of more than 9,000 respondents from nine countries of the

world. The most important findings are as follows: consumer expects high standards in the field of ecology; and is confident that an enterprise can do more than an individual in terms of environmental protection; however, the uncertainty related to all it concerns is relatively high; the consumer is willing to pay a little more for an organic product; while the added value of the product is demanding – it is tastier, healthier, safer, or has the ability to save money or save energy. At the same time, a more significant barrier than the high price of such products, according to the consumer, appears to be the lack of awareness and a perceived lack of offer. Consumer considers purchase behavior to be an important way to show environmental responsibility. Approximately one half of respondents buy organic products regularly or occasionally. Interestingly, almost all respondents admit that they are confused when buying organic products, with regard to finding it hard to define what the attribute ‘ecological’ means, what benefits are associated with it, and which products can in fact be labeled as ecological. No less significant was the fact that, from the point of view of sources for their information, consumers expressed highest confidence in consumer reports, followed by scientific and academic publications, while producers were only placed eighth (Manget *et al.*, 2009).

The examples of criteria that the consumer evaluates in this type of purchase are: recyclability, biodegradability, material and energy production, transport distance from producer to consumer, and others (Musová, 2013).

Tweeneboah and Braihman (2011), and Tanner and Kast (2003) found out that consumers are insufficiently informed about ESP, which affects their purchasing decisions. According to Makatouni (2002), the ESP is often connected with environmentally sustainable business activities. Consumers place high demands on enterprises from the ecological point of view, and in particular, they require quality of the products, which they are willing to pay for. It is therefore a challenge for enterprises to decide which steps will be taken and which product life-cycles will be considered the most important in the process of creating and delivering quality and ESP to the market.

The research of ESP development, which is the object of this study, is based on the assessment of the ESP perception by Slovak consumers of wood-processing SMEs. The research results were obtained by testing the statistical hypotheses. Based on the findings, recommendations were formulated for the wood-processing SMEs in Slovakia to ensure environmentally sustainable development of their products, according to the requirement of Slovak consumers.

## 2 MATERIALS AND METHODS

### 2. MATERIJALI I METODE

The research was conducted in two phases. In the first phase, in 2017, a secondary research was conducted, aimed at the analysis of the domestic and foreign literature, in order to compare the opinions of different

authors concerning the given problem, as well as to develop theoretical foundations for the questionnaire. The second phase, carried out in 2018, was based on a primary research, which was done through the questioning method – a questionnaire. The objective of the research was to identify the perception of an ESP by consumers, as well as the factors that consumers take into account when deciding about purchasing the ESPs of wood-processing enterprises in Slovakia.

Based on the theoretical backgrounds and empirical studies on the subject (Nozarah, 2016; Chen *et al.*, 2018; Pinto *et al.*, 2016; Chen *et al.*, 2015; Roman *et al.*, 2015; and Ali and Amir, 2016), hypothesis H<sub>0</sub> was formulated, which assumes that most Slovaks agree with the claim that it is necessary to offer ESPs of wood-processing and forestry SMEs. From the initial hypothesis, four partial hypotheses emerged:

H<sub>1</sub>: It is assumed that more women than men have encountered the term of an ESP of wood processing and forestry SMEs.

H<sub>2</sub>: It is assumed that ESP quality is important to consumers, regardless of their income.

H<sub>3</sub>: It is assumed that most respondents are willing to pay more for an ESP of wood processing and forestry SMEs than for a regular product.

H<sub>4</sub>: It is assumed that the most important factor that affects the decision to buy an ESP of wood-processing and forestry SMEs is the price.

To verify the assumptions, the research used methods of inference statistics (Chi-square test, the Binomial test, the Friedman test, the Wilcoxon test and the level compliance test), methods of descriptive statistics (relative frequency, cumulative relative frequency, and methods of distribution description), and data visualization (mean, modus, median, graphs, and frequency tables). The representativeness of the sample was tested by Chi-square test, using the chosen variables. Friedman test was used to analyze the significance of differences between related samples, and the Wilcoxon test assessed the agreement between the responses in two different samples.

### 2.1 Data collection

#### 2.1. Prikupljanje podataka

The data collection was specifically designed to determine the perception of an ESP by consumer, and to identify the factors that consumer take into account when deciding about purchasing the ESPs of wood-processing enterprises in Slovakia. The questionnaire was designed in two parts:

Part A – seven questions: characteristics of respondents (A1 – A7), and

Part B – six questions: how respondents perceive an ESP of wood processing SMEs in Slovakia and how their purchasing decision are affected (B1 – B6).

Part A was focused on characteristics of respondents (gender, age, level of education, employment status, monthly income, region, residence. Part B consisted of six questions aimed at finding out how respondents perceive an ESP from wood processing SMEs in Slovakia and how their purchasing decisions are affected.

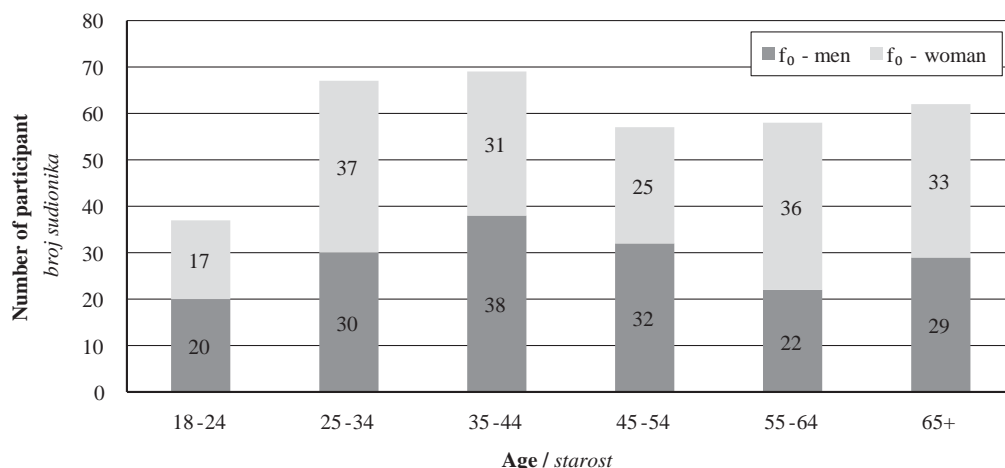

**Figure 1** Respondents according to age and gender  
**Slika 1.** Ispitanici prema dobi i spolu

The survey identified whether respondents have already encountered the concept of an ESP. The level of agreement with the statements about the ESP was identified. Subsequently, the factors that respondents take into account when deciding to buy ESP of wood-processing SMEs, and the reasons why respondents buy or do not buy them, were determined. At the same time, the intensity of the perception of price was observed.

## 2.2 Characteristics of respondents

### 2.2. Osobine ispitanika

754 respondents participated in the survey, and the questionnaire was distributed by email. ESPs of wood processing SMEs were the object, and the adult inhabitants of Slovakia were the subject of the research. In order to ensure the representativeness of the sample, 350 correctly filled in questionnaires were used (46.42 % response rate). 171 men and 179 women participated in the survey. Most respondents (Figure 1) were aged between 35-44 (69) and between 25-34 (67). Least respondents were aged between 18-24 (37) and 45-54 (57).

Considering the level of their education (Figure 2), most respondents (226) claim to have completed secondary education, of which 99 have completed the secondary education without the graduation exam, and 127 with. Fewer respondents have achieved the master's degree (56) and doctoral degree (4).

The majority of respondents are full-time employed (54.6 %), freelancers or entrepreneurs (13.7 %) and retired (17.1 %). The least represented group was that of housewives/househusbands (0.3 %), disabled (1.1 %), and the unemployed (1.4 %). In terms of monthly net income, the largest group consists of respondents with the income between €201-400 (22 %) and €401-600 (24.9 %). Least respondents were from the income group above €1,500 (3.1 %), and up to €200 (4.9 %). The majority of our respondents (76.9 %) are from income groups between €201-1,000. The respondents answered the question about their residence, where 22.9 % stated to live in town over 50,000 inhabitants, 37.7 % in a town up to 50,000 inhabitants, and 39.1 % live in a village. Most respondents are from the Prešov region (29.7 %), Banská Bystrica region

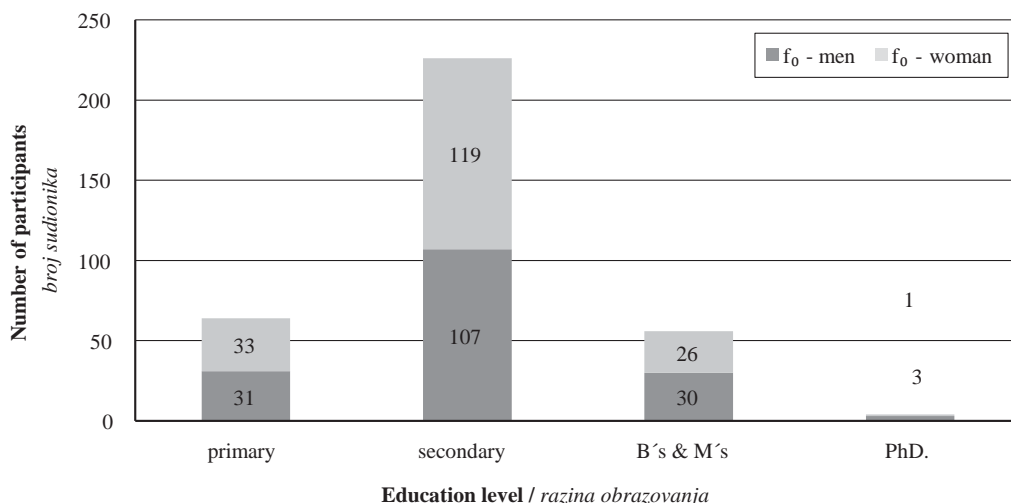

**Figure 2** Respondents according to education level and gender  
**Slika 2.** Ispitanici prema stupnju obrazovanja i spolu

**Table 1** Chi-square test of representability of respondent sample

**Tablica 1.** X<sup>2</sup>-test reprezentativnosti uzorka ispitanika

Statistical testing / Statističko testiranje					
Gender / Spol		Age / Starost		Education / Obrazovanje	
Chi-square / X <sup>2</sup>	.000 <sup>a</sup>	Chi-square / X <sup>2</sup>	.011 <sup>a</sup>	Chi-square / X <sup>2</sup>	.234 <sup>a</sup>
Degrees of freedom <i>Stupanj slobode</i>	1	Degrees of freedom <i>Stupanj slobode</i>	5	Degrees of freedom <i>Stupanj slobode</i>	4
p-value <i>Vrijednost p</i>	.983	p-value <i>Vrijednost p</i>	1.000	p-value <i>Vrijednost p</i>	.994
a. 0 cells, (0 %) have expected frequencies less than 5. The minimum expected cell frequency is 170.8. <i>a. očekivanje od 0 (0 %) manje je od 5. Najmanje očekivana frekvencija iznosi 170,8.</i>		a. 0 cells (.0 %) have expected frequencies less than 5. The minimum expected cell frequency is 37.1. <i>a. očekivanje od 0 (0 %) manje je od 5. Najmanje očekivana frekvencija iznosi 37,1.</i>		a. 1 cell (20.0 %) have expected frequencies less than 5. The minimum expected cell frequency is 3.2. <i>a. očekivanje od 1 (20 %) manje je od 5. Najmanje očekivana frekvencija iznosi 3,2.</i>	

(27.7 %), and Žilina region (23.7 %). The least represented (2 %) were regions of Nitra and Trenčín.

The sample representativeness (Table 1), according to the selected criteria – gender, age and the achieved level of education, was tested by the Chi-square test, and was confirmed in all cases ( $p\text{-value}_{\text{gender}} = 0.983$ ,  $p\text{-value}_{\text{age}} = 1.0$ ,  $p\text{-value}_{\text{education}} = 0.994$ ).

**2.3 Methods of research analysis**

**2.3. Metode analize rezultata istraživanja**

The survey data were analyzed by descriptive methods, graphic visualization, and statistical analysis.

The second part of the questionnaire consisted of six questions aimed at finding out how Slovak respondents perceive a green product of wood-processing enterprises, and what influences their purchasing behavior. Question B1 attempted to find out if respondents have already encountered the term green product, and this question relates to hypothesis H<sub>1</sub>. Question B2 focused on finding out the degree of consent with statements about a green product. It is evaluated by Likert scale, where 1 represents strong agreement and 4 represents strong disagreement. Likert scale enables evaluation of both the attitude of the respondent and its intensity. Question B3 asked which factors respondents take into account when making purchasing decisions about the green product. Respondents could choose from 1 – always, 2 – often, 3 – sometimes, and 4 – never take into account. Evaluation of question B3 relates to hypothesis H<sub>2</sub>. Questions B4 and B5 asked about the reasons why respondents purchase, or do not purchase, green products. Respondents were asked to choose three most relevant factors. Evaluation of question B5 relates to hypothesis H<sub>4</sub>. Question B6 investigated the intensity of price perception by respondents, while focusing on finding out how much respondents are willing to pay for a green product. The evaluation of question B6 is related to hypothesis H<sub>3</sub>.

The representativeness of the sample according to the selected criteria – gender, age and achieved education was tested by the Chi-square test, as stated above. The Chi-square test is the sum of amplified differences between the observed (O) and expected (E) values, divided by the expected frequency (E):

$$\chi^2 = \sum_{i=1}^N \frac{(O_i - E_i)^2}{E_i} \tag{1}$$

Pearson’s Chi-square goodness of fit test is based on a frequency table and tests the statistical hypothesis that the frequencies in each category are equal to the expected (theoretical) frequencies (Kaščáková and Nedel’ová, 2010).

The hypotheses were tested at a significance level of 0.05.

When evaluating the research results, the applied methods of testing statistical hypotheses were: the binomial test, Chi-square test, Friedman test, Wilcoxon test, and the methods of descriptive statistics and data visualization.

Hypotheses H<sub>1</sub> and H<sub>2</sub> were verified by the significance test of Spearman’s correlation coefficient. Correlation is interdependence of two or more variable quantities, and the correlation coefficient may achieve values between -1 to +1. Value -1 represents the highest negative, and +1 the highest positive correlation, while value 0 means no correlation (Kaščáková and Nedel’ová, 2010). This coefficient enabled us to investigate the dependence of respondents’ answers on gender, age, income, and the achieved level of education. If p-value is lower than 0.05, there is correlation between the signs. If the value of the correlation coefficient is negative with regard to gender, it means that more agreement was expressed by women than men; With age, it means that older age categories agree more than younger respondents; with income, it indicates that those with higher income agree more than those with lower income; and with the level of education, more agreement is achieved by those with higher educational level. If p-value is higher than 0.05, it means that the responses to questions are independent of the individual criteria.

To test hypothesis H<sub>3</sub>, the exact binomial test was used, as this test validates statistical hypothesis related to the ratio of agreement of the basic sample with the constant. Binomial distribution has parameters n and π<sub>0</sub>; if  $x < (n-x)$  and  $p > \pi_0$ , then the alternative hypothesis is  $\pi > \pi_0$ .

To test hypothesis H<sub>4</sub>, the Friedman and Wilcoxon tests were used. The Friedman test is the non-pa-



metric alternative to the one-way ANOVA test (Analysis of Variance) with repeated measures. It is used to test the differences between groups when the measured dependent variable is ordinal. It can also be used for continuous data that has violated the assumptions necessary to run the one-way ANOVA with repeated measures (e.g. data that has marked deviations from normality). In case the hypothesis concerning the agreement of the levels of different dependent choices is rejected, it is possible to compare the pairs of choices aiming at the identification of the significant differences between the levels of responses, i.e. to continue testing with the use of the Wilcoxon test. The Wilcoxon signed-rank test is the nonparametric test equivalent to the dependent *t*-test. As the Wilcoxon signed-rank test does not assume normality in the data, it can be used when this assumption has been violated and the use of the dependent *t*-test is not recommended. It can be used to compare two sets of ordinal data.

### 3 RESULTS AND DISCUSSION

#### 3. REZULTATI I RASPRAVA

##### 3.1 Results of empirical research

##### 3.1. Rezultati iskustvenog istraživanja

The questions B1 of the questionnaire focused on whether respondents had already encountered the concept of an ESP. Up to 73.4 % of respondents have already encountered the concept of an ESP and 26.6 % indicated the option of not knowing this concept. The evaluation is connected with hypothesis H<sub>1</sub>, which suggests that more men than women have already encountered the term ESP. Spearman's rank correlation coefficient revealed that the answers to the question were gender-independent (*p*-value = 0.067). Based on this, the H<sub>1</sub> hypothesis was rejected. At the same time, the survey determined that the answers to this question are independent of age (*p*-value = 0.54), income (*p*-value = 0.243) and the respondents education (*p*-value = 0.953). The questionnaire then surveyed what the respondents consider to be an ESP (question B2). Fifteen statements were presented to the respondents, and they had to indicate the degree of consent on the Likert scale for each statement. The Friedman test confirmed that the statements about what an ESP is, are not equally important for respondents in terms of their consent level (*p*-value = 0.0). By means of the Wilcoxon signed-rank test, it was verified which statements were not equally significant. It can be stated that Slovaks mostly agree with the statement that an ESP is an environmentally friendly product. Up to 91 % of Slovaks indicated that they agree or strongly agree with this statement. Slovaks also agree with the statement that an ESP is recyclable, that its use has a minimum nega-

cept of an ESP. Up to 73.4 % of respondents have already encountered the concept of an ESP and 26.6 % indicated the option of not knowing this concept. The evaluation is connected with hypothesis H<sub>1</sub>, which suggests that more men than women have already encountered the term ESP. Spearman's rank correlation coefficient revealed that the answers to the question were gender-independent (*p*-value = 0.067). Based on this, the H<sub>1</sub> hypothesis was rejected. At the same time, the survey determined that the answers to this question are independent of age (*p*-value = 0.54), income (*p*-value = 0.243) and the respondents education (*p*-value = 0.953). The questionnaire then surveyed what the respondents consider to be an ESP (question B2). Fifteen statements were presented to the respondents, and they had to indicate the degree of consent on the Likert scale for each statement. The Friedman test confirmed that the statements about what an ESP is, are not equally important for respondents in terms of their consent level (*p*-value = 0.0). By means of the Wilcoxon signed-rank test, it was verified which statements were not equally significant. It can be stated that Slovaks mostly agree with the statement that an ESP is an environmentally friendly product. Up to 91 % of Slovaks indicated that they agree or strongly agree with this statement. Slovaks also agree with the statement that an ESP is recyclable, that its use has a minimum nega-

**Table 2** Factors taken into account by consumers when deciding to purchase an ESP

**Tablica 2.** Čimbenici koje korisnici uzimaju u obzir pri donošenju odluke o kupnji ekološki održivog proizvoda

Friedman test / Friedmanov test		Wilcoxon signed-rank test / Wilcoxonov test							
Number of observations <i>Broj opažanja</i>	221		c - a	b - c	f - b	h - f	l - h	k - l	n - k
Chi-square / $X^2$	1336.74	Testing statistics <i>Statistika testiranja</i>	-0.765a	-4.878a	-2.426b	-4.021a	-0.327a	-2.954a	-5.821a
Number of degrees of freedom <i>Broj stupnjeva slobode</i>	14	p-value <i>Vrijednost p</i>	0.450	0.000	0.015	0.000	0.744	0.003	0.000
p-value <i>Vrijednost p</i>	0.000		g - n	d - g	j - d	i - j	m - i	e - m	o - e
		Testing statistics <i>Statistika testiranja</i>	-3.137a	-6.876a	-0.960b	-2.915a	-0.831b	-0.853a	-5.844a
	p-value <i>Vrijednost p</i>	0.002	0.000	0.337	0.004	0.406	0.394	0.000	
Legend: a. Product quality / <i>kvaliteta proizvoda</i> b. Product safety / <i>sigurnost proizvoda</i> c. Product price / <i>cijena proizvoda</i> d. Product recyclability / <i>oporabivost proizvoda</i> e. Recyclability of product packaging / <i>oporabivost ambalaže proizvoda</i> f. Warranty period / <i>jamstveni rok</i> g. Environmentally friendly product / <i>prihvatljivost proizvoda za okoliš</i> h. Energy efficiency / <i>energetska učinkovitost</i> i. Biodegradable product / <i>biorazgradivost proizvoda</i> j. Reduces waste / <i>ne pridonosi povećanju otpada</i> k. Made in Slovakia / <i>proizveden u Slovačkoj</i> l. Simplicity of use / <i>jednostavnost uporabe</i> m. Ecological label / <i>ekološka oznaka</i> n. Produced from natural materials / <i>proizvod od prirodnih materijala</i> o. Ecologically transported / <i>ekološki transport</i>									

tive impact on the environment, and an environmental label. The least agreement was observed with the statement that it is a product that is transported in an environmentally friendly way.

Based on the results of the level compliance test, it can be concluded that the agreement with the statement that the ESP is environmentally friendly is independent of the gender ( $p$ -value = 0.181), age ( $p$ -value = 0.111), education ( $p$ -value = 0.679), and income of the respondents ( $p$ -value = 0.384). The level compliance test confirmed dependence of the statement that ESP is recyclable. Respondents with the university degree agree with this statement more ( $p$ -value = 0.049,  $r$  = -0.116). At the same time, women are more inclined to claim that ESP is a healthy product ( $p$ -value 0.019,  $r$  = -0.133), high quality product ( $p$ -value 0.003,  $r$  = -0.174) and ecologically transported ( $p$ -value 0.033,  $r$  = -0.145). Respondents with higher income ( $p$ -value = 0.014,  $r$  = -0.169) agree with the statement that ESP is the product for whose production alternative energy sources are used. Based on the survey results, it can be concluded that consumer perception of an ESP is mainly linked to its positive environmental impact. Recyclability of the product is perceived as an important part of it.

Subsequently, the survey focused on the factors considered by consumers when deciding to buy an ESP (question B3). According to frequencies of the answers to the given options, it can be stated that consumers most often indicated that they always take into account the price and quality of the product. The Friedman test confirmed that the options are not equally significant ( $p$ -value = 0). Next, the Wilcoxon signed-rank test determined the order of significance of individual statements (Table 2).

Slovaks most often take into account the quality and price of the product. This is followed by product safety and the warranty period. They also take into consideration the energy efficiency and ease of use. The product biodegradability, ecological label, and the recyclability of the product packaging are considered

least relevant. Ecological transport of the product took the last place.

The level compliance test determined that product quality is important to consumers regardless of their gender ( $p$ -value = 0.081), age ( $p$ -value = 0.178), education ( $p$ -value = 0.278), and income ( $p$ -value = 0.14). Thus, hypothesis  $H_2$  was confirmed, which assumes that quality of the ESP is important to consumers regardless of their income. Hypothesis  $H_2$  is accepted. In terms of price, more women than men consider this factor when buying ESP ( $p$ -value = 0.041,  $r$  = -0.109). Also, women more frequently take into account whether the product is made of natural materials ( $p$ -value = 0.015,  $r$  = -0.155). Younger respondents consider whether the product is recyclable ( $p$ -value = 0.021,  $r$  = 0.128), while most of these factors are taken into account by higher-income respondents.

In addition, there are reasons why consumers did or did not purchase the products (questions B4 and B5).

Most frequently indicated reasons for purchasing ESP were that ESPs have a positive impact on health, are of high quality, and provide good feeling. This is followed by good brand name of the product, care about the health of the whole family, healthy lifestyle, reasonable price, high efficiency of the product (e.g. saving energy), and convincing advertising. The other factors are ecological packaging, the fact that consumers save money, and the attractive design of the products. The least indicated reasons for the purchase were the improvement of consumer's own image, the fact that the products save time, and the products' good availability. The level compliance test determined that the majority of the reasons for purchasing environmental products was independent of gender, age, education, and income of the respondents ( $p$ -value was greater than 0.05). The only dependence in this case was found in the possibility of having a positive impact on the health of the consumer, where this factor is taken into account by respondents with lower education ( $p$ -value = 0.019,  $r$  = 0.125). These respondents also consider

**Table 3** Reasons why respondents do not purchase ESPs

**Tablica 3.** Razlozi zbog koji ispitanici ne kupuju ekološki održive proizvode

Friedman test / Friedmanov test		Wilcoxon signed-rank test / Wilcoxonov test							
Number of observations <i>Broj opažanja</i>	350		e - c	d - e	b - d	g - b	a - g	h - a	f - h
Chi-square / $X^2$	547.444	Testing statistics <i>Statistika testiranja</i>	-4.041a	-0.244a	-6.265a	-2.294a	-2.661a	-0.480a	-0.707a
Number of degrees of freedom <i>Broj stupnjeva slobode</i>	7	p-value <i>Vrijednost p</i>	0.000	0.807	0.000	0.022	0.008	0.631	0.480
p-value <i>Vrijednost p</i>	0.000	Legend: a. Distrust in ESP / <i>nepovjerenje u ekološki održive proizvode</i> b. I am not sure about the quality of such products / „ <i>Nisam siguran u kvalitetu takvih proizvoda.</i> “ c. They are too expensive / <i>preskupi su</i> d. They are less available on the market / <i>rjeđe su dostupni na tržištu</i> e. There is little information about ESP / <i>premalo je informacija o ekološki održivim proizvodima</i> f. They are not suitable for everyday use / <i>nisu prikladni za svakodnevnu uporabu</i> g. They do not offer any benefits for me / „ <i>Od njih nemam nikakve koristi.</i> “							

**Table 4** Reasons why respondents do not purchase ESPs**Tablica 4.** Razlozi zbog koji ispitanici ne kupuju ekološki održive proizvode

Binomial test / Binomni test					
o15_code	Category Kategorija	Number of observations Broj opažanja	Sampling rate Frekvencija odgovora	Test portion Mjera testa	Bilateral p-value Bilateralna vrijednost p
Group 1 / Skupina 1.	1.00	215	0.61	0.50	0.000
Group 2 / Skupina 2.	0.00	135	0.39		
Total / Ukupno		350	1.00		

the fact that environmental product has a positive impact on family health ( $p$ -value = 0.015,  $r$  = 0.130). The reason that ESP saves energy is taken into account more by women than men ( $p$ -value = 0.007,  $r$  = -0.144).

The most frequently indicated reason for not purchasing ESPs was their high price (Table 3). Based on this finding, hypothesis  $H_4$  was accepted. Frequently identified reasons also included little information on ESPs, and poor market accessibility. The next reasons were 'I am not sure of their quality' and 'They do not offer any benefits to me'. The least indicated reasons were distrust in ESPs and their unsuitability for everyday use. The level compliance test revealed that price, as the most important reason why respondents do not purchase ESP, is independent of their gender ( $p$ -value = 0.49), age ( $p$ -value = 0.935) and education ( $p$ -value = 0.38). Dependence on the income of respondents was confirmed ( $p$ -value = 0.0). Women do not buy ESPs because they distrust them ( $p$ -value = 0.033,  $r$  = -0.114), and the products do not offer any benefits to them ( $p$ -value = 0.030,  $r$  = -0.116). The reason why the ESPs are not suitable for everyday use was indicated more by older respondents than the younger ones ( $p$ -value = 0.0180,  $r$  = -0.126), while it was mostly respondents with lower education who were not sure about the product quality ( $p$ -value = 0.003,  $r$  = 0.158).

The last surveyed subject was the perception of price. The survey verified how much respondents were willing to pay for the ESP (question B6). Up to 34 % of respondents are willing to pay the same price for an ESP as for a regular product; 4.6 % are willing to buy these products if they are less expensive, and 5.4 % say they do not care about the price. Hypothesis  $H_3$ , which assumes that most Slovaks are willing to pay for an ESP more than for a regular product, is associated with the evaluation of this statement. By a binomial test (Table 4), hypothesis  $H_3$  was confirmed ( $p$ -value = 0).

Based on the survey results, it can be stated that most Slovaks agree with the statement that it is necessary to offer ESPs. Enterprises should consider introducing environmental activities that result in providing ESPs, and thus contribute to environmental protection. The survey has also revealed that most Slovaks are willing to pay more for an ESP than for a regular one. On the other hand, the price is the most important factor that affects them when deciding about the product purchase. It can be claimed that Slovaks are interested in purchasing ESPs; however, they are significantly influenced by the product price.

### 3.2 Suggestions on implementing ESP innovations in Slovak wood-processing SMEs

3.2. Prijedlozi za uvođenje inovacija ekološki održivih proizvoda u mala i srednja poduzeća u Slovačkoj preradi drva

Wood-processing enterprises offer a number of options to make an effective contribution to sustainable development and to offer consumers an ESP as a result of their activities.

There are several causes of environmental damage, an important position among them being held by those that are related to entrepreneurial activities and ecologically inappropriate concept of products (Ve-tráková *et al.*, 2013). Improvement of environmental conditions and reduction of the negative impacts of civilization on the environment cannot be achieved without the participation of business entities. The offer of ESPs motivates consumers to consume without regret, and at the same time, it ensures sustainable development. Such concept is accepted positively by both the enterprises and the ecologists. Wood-processing enterprises should have a responsible attitude towards the environment, and manifest long-term commitment to sustainable development of their business, by implementing environmentally sustainable activities and offering ESPs.

The survey determined that most Slovaks have already encountered the concept of an ESP of wood-processing SMEs. The responses were independent of gender, income, age and education. Therefore, it can be stated that there is an increasing interest in ESPs from wood-processing SMEs in Slovakia, and that Slovaks are interested in the products whose consumption does not burden the environment. Based on the survey results, it is possible to conclude that consumer perception of ESP is mainly linked to its positive environmental impact. The recyclability of the product is perceived as its important component. It was interesting to find out that most Slovaks agree with the statement that it is necessary for wood-processing enterprises to include ESPs in their offer ( $H_0$ ). Research of several authors conducted in Asian, European, and African countries (Chen *et al.*, 2018; Pinto *et al.*, 2016; Barber *et al.*, 2009) also confirmed an increasing trend of consumer interest in purchasing ESPs.

When deciding to buy an ESP from wood-processing SMEs, quality is important for consumers regardless of their age, gender, education or income. The same result regarding the relationship between the

level of education and the use of ESP was proved by a study of Shamsi and Siddiqui (2017). Most frequently indicated reasons for purchasing these products were that they have a positive impact on health, that they are of high quality, and provide a good feeling. This is followed by product safety and the length of warranty period. Consumers also take into consideration the energy efficiency and simplicity of use. The product biodegradability, ecological label and recyclability of the product packaging are considered to be less relevant. The last place is held by the ecological transport of the product. Similar results were obtained by Liao (2013), who found that the factors that influence consumer behaviour when purchasing ESP are as follows: the product saves resources and energy; it is made of recyclable materials; it is reusable and recyclable; and does not burden the environment. Based on the research findings, it is possible to agree with the results of a Taiwanese and Spanish researcher (Lai *et al.*, 2003; Leal-Rodriguez *et al.*, 2017; Yang *et al.*, 2017), who claim that ESP development should focus on energy saving, pollution prevention, waste recycling, and non-toxic product design.

The most frequently indicated reason for not purchasing ESPs was their high price (H4), a trend that was also observed by the European Commission ([www.ec.europa.eu](http://www.ec.europa.eu)). Frequently identified reasons included little information on ESP and poor market accessibility. On the one hand, it was concluded that consumers are interested in such products, but on the other, they often do not know the added value that the ESP generates. The consumer is not aware of the benefits of ESP, such as reducing the amount of waste, which may be viewed as an opportunity for wood-processing enterprises to use the environmental characteristics of products as a competitive advantage. Lower prices and the right advertisement of a new ESP can open new business opportunities and thus contribute to the increase in profits (Biernacka and Sedliačiková, 2012). We can agree with the European researchers (Schiederig *et al.*, 2012; Albort-Morant *et al.*, 2018, Malá *et al.*, 2017a), who claim that consumers should be informed about the fact that by purchasing an ESP, they contribute to the protection of the environment, and also about how the enterprise protects the environment. Consumers, who are sufficiently informed about ESPs, believe that the purchase of these products is beneficial to the environment, which has a positive impact on their purchasing decisions and on prioritizing ESP (H3), which was also suggested by Taiwanese researchers (Norazah, 2016). Providing true information about the environmental aspects of products also influences the consumer confidence in the enterprise (Chen *et al.*, 2015). All environmental activities performed by an enterprise lead to the creation of an ESP or service, so the enterprise should keep its consumers informed of that fact (Pekkanen *et al.*, 2018). If an enterprise chooses an appropriate innovative marketing strategy to highlight the environmental components of the product and its sustainable business activities, it should also increase the sales. Besides this, the product gains

interest of both current and potential European consumers, while the enterprise improves its image and strengthens its sustainable competitive advantage (Buhl *et al.*, 2016). Based on the research results, wood-processing enterprises are recommended to provide true information about the quality of the products they offer. If consumers have true and complete information, they can avoid buying products that they are not interested in, and thus reduce the cost of service, repairs, complaints, or additional shipping costs. An enterprise that sells ESPs should pay attention to informing the consumer of the nature of ESP, why its purchase is more favourable than a traditional equivalent, and what benefits it brings to the environment and to the consumer (Liu *et al.*, 2017). Similarly, enterprises should inform their consumers about the best ways to care for the product, which can extend the lifetime of the product, thus avoiding the waste of money and natural resources of the planet. We agree with the recommendations of Pinto *et al.* (2016) to educate consumer on ESP claims. This will enhance consumer loyalty and increase the sale of ESPs. It is necessary to emphasize the information about how to use the product properly, and how to dispose of it correctly. What is essential in this respect is to inform and educate the consumer about the benefits of ecological thinking associated with adequate action.

Most Slovaks are willing to pay more for products and services of wood-processing enterprises that have a positive influence on the environment, which relates to product quality (H<sub>2</sub>). The same results were achieved by Taiwanese, Malaysian and Romanian researchers (Chen *et al.*, 2015; Ghazali *et al.*, 2017; Roman *et al.*, 2015). A Pakistani researcher (Ali and Amir, 2016) found that, if an enterprise produces more ESPs, consumers tend to buy more of its products.

Reducing negative impacts of products throughout their life cycle is the basis for ESP development. Wood processing enterprises that develop ESPs face several challenges. One of the main challenges is to integrate the environmental and conventional features of the product (e.g. by avoiding compromises between the products' qualitative and environmental characteristics).

Consumers and their requirements should represent the foundation for a wood-processing enterprise to implement initiatives for ESP development. Sustainable consumption was seen to have the leading growth rate (Liu *et al.*, 2017), as also confirmed by our research.

Various authors from Australia, Europe, and Asia (Sedliačiková *et al.*, 2014; Fraj-Andres and Martínez-Salinas, 2007; Syaekhoni *et al.*, 2017) found that, if an enterprise invests in ESP development, it can achieve effective use of its sources, quick return on investment, increase in sales, improve business image, ensure product differentiation from competition, and penetrate into new markets more easily.

Protecting the environment by reducing waste and consumption of natural resources and energy provides many entrepreneurial opportunities for sustaina-

ble development. This development should result in innovations for wood-processing enterprises that would lead them to provide products and services that meet consumer requirements and environmentally friendly production and consumption.

#### 4 CONCLUSIONS 4. ZAKLJUČAK

Based on the analysis of the theoretical foundations of the given problem, and on the results of our research, it has been found out that, following the perception of consumers, wood-processing enterprises should focus their ESP development on three areas – energy saving, pollution prevention, and waste recycling. The main objective of the research has been achieved.

Our research has revealed how adult Slovaks understand the term ESP. They were asked about their opinion on how important it was for wood-processing enterprises to offer ESPs, with the focus on finding out their concerns when purchasing these products; the reasons why they purchase or do not purchase ESPs, and the intensity of their perception of the ESP price. Most respondents understand the term ESP as ecologically friendly and healthy.

Consistent with hypothesis  $H_0$ , the results of our research revealed that most Slovaks agree with the statement that it is necessary to provide ESPs in the market. Hypothesis  $H_0$  was accepted.

Our research has confirmed that as much as 73.4 % of respondents have already encountered the term ESP, while 26.6 % have never heard of this concept. In line with hypothesis  $H_1$ , which suggests that more men than women have already encountered the term ESP of wood-processing enterprises, it was proved, by applying the Spearman rank correlation coefficient test, that the responses are independent of gender. Based on this, hypothesis  $H_1$  was rejected.

Hypothesis  $H_2$  assumed that the quality of ESPs of wood-processing enterprises is important to consumers, regardless of their income, which was confirmed by the level compliance test ( $p$ -value = 0.14). Thus hypothesis  $H_2$ , which assumes that the quality of the ESP is important to consumers regardless of their income, was confirmed. Hypothesis  $H_2$  was accepted.

As many as 34 % of respondents were willing to pay the same price for an ESP of wood-processing enterprises as they would for a regular one, 4.6 % would pay less, and 5.4 % claimed that the price was irrelevant for them. Hypothesis  $H_3$ , which assumed that the majority of Slovaks would pay more for the ESP as they would for a regular product, was confirmed by binomial test. Hypothesis  $H_3$  was accepted.

The most frequently indicated reason for not purchasing ESP from wood processing enterprises was their high price ( $H_4$ ). The results of our research confirmed hypothesis  $H_4$ .

The summary of the research results leads to the following conclusions: the most indicated reasons to buy ESPs from wood-processing enterprises are that

these products have a positive impact on the health of consumers, and are of high quality. Most Slovaks are willing to pay more for the products that have a positive environmental impact of such wood-processing enterprises.

The findings and conclusions of the present research are limited in that the research focused on wood-processing enterprises, while more precise and applicable results could be achieved with the focus on more industries. Therefore, future research should focus on specific differences between implementing the development of ESPs, as well as on differences between the respective industries. Since the research was conducted on a sample of the adult population of Slovakia, further exploration could be extended to the population of the European Union or to comparing the perception of an ESP by Slovak consumers (consumers of the European Union) with the consumers outside the EU.

#### Acknowledgements – Zahvala

The paper has been written as a partial result of the projects VEGA No.1/0318/19 and No. 1/0010/17 and projects APVV-18-0520, APVV-18-0378, APVV-17-0456 and APVV-17-0583.

#### 5 REFERENCES 5. LITERATURA

1. Albort-Morant, G.; Henseler, J.; Cepeda-Carrión, G.; Leal, Rodríguez, A. L., 2018: Potential and realized absorptive capacity as complementary drivers of green product and process innovation performance. *Sustainability*, 10: 1-20. <https://doi.org/10.3390/su10020381>.
2. Ali, M.; Amir, M., 2016: Pro-environmental products: Marketing influence on consumer purchase decision. *Arabian Journal of Business and Management Review*, 5 (6): 1-15.
3. Barber, N.; Taylor, C.; Strick, S., 2009: Wine consumers' environmental knowledge and attitudes: Influence on willingness to purchase. *International Journal of Wine Research*, 1: 59-72. <https://doi.org/10.2147/IJWR.S4649>.
4. Benčíková, D.; Poliak, P., 2016: Intercultural competences in international organizations. Globalization and its socio-economic consequences: In: Proceedings of the 16th International Scientific Conference, Rajecké Teplice, Slovakia.
5. Biernacka, J.; Sedliačiková, M., 2012: Selected Ratio and Bankruptcy Early-Warning Method Analysis of Competitiveness of Wood Sector Companies. *Drvna industrija*, 63 (3): 187-193. <https://doi.org/10.5552/drind.2012.1212>.
6. Buhl, A.; Blazejewski, S.; Dittmer, F., 2016: The Merrier: Why and How Employee-Driven Eco-Innovation Enhances Environmental and Competitive Advantage. *Sustainability*, 8 (9): 946. <https://doi.org/10.3390/su8090946>.
7. Chen, Ch. Ch.; Chen, Ch. W.; Tung, Y. Ch., 2018: Exploring the consumer behaviour of intention to purchase green products in belt and road countries: an empirical analysis. *Sustainability*, 10 (3): 1-18. <https://doi.org/10.3390/su10030854>.
8. Chen, Y. S.; Lin, Ch. Y.; Weng, Ch. S., 2015: The influence of environmental friendliness on green trust: The

- mediation effects of green satisfaction and green perceived quality. *Sustainability*, 7 (8): 10135-10152. <https://doi.org/10.3390/su70810135>.
9. Dangelico, R. M.; Pujari, D., 2010: Mainstreaming Green Product Innovation: Why and How Companies Integrate Environmental Sustainability. *Journal of Business Ethics*, 95 (3): 471-486. <https://doi.org/10.1007/s10551-010-0434-0>.
  10. Dubihlela, J.; Ngxukumeshe, T., 2016: Eco-friendly Retail Product Attributes, Customer Attributes and the Repurchase Intentions of South African Consumers. *International Business & Economics Research Journal*, 15 (3): 163-174. <https://doi.org/10.19030/iber.v15i4.9754>.
  11. Fraj-Andres, E.; Martínez-Salinas, E., 2007: Impact of environmental knowledge on ecological consumer behaviour: an empirical analysis. *Journal of International Consumer Marketing*, 19 (3): 73-102. [https://doi.org/10.1300/J046v19n03\\_05](https://doi.org/10.1300/J046v19n03_05).
  12. Ghazali, I.; Abdul-Rashid, S. H.; Dawal, S. Z. M.; Aoyama, H.; Tontowi, A. E.; Sakundarini, S., 2017: Cultural influences on choosing green products: An empirical study in Malaysia. *Sustainable development*, 25 (6): 655-670. <https://doi.org/10.1002/sd.1685>.
  13. Herchen, O., 2007: *Corporate Social Responsibility*. Nordested, Germany: Books on Demand.
  14. Hosseinpour, A.; Peng, Q.; Gu, P., 2015: A benchmark-based method for sustainable product design. *Benchmarking. An International Journal*, 22 (4): 643-664. <https://doi.org/10.1108/BIJ-09-2014-0092>.
  15. Kaščáková, A.; Nedel'ová, G., 2010: Štatistické metódy pre spoločenskú a humanitnú vedu. Banská Bystrica, SK: Univerzita Mateja Bela v Banskej Bystrici.
  16. Lai, S. B.; Wen, C. T.; Chen, Y. S., 2003: The exploration of the relationship between the environmental pressure and the corporate competitive advantage. In: *Proceedings of the 2003 CSMOT Academic Conference*, Hsin-Chu, Taiwan.
  17. Leal-Rodríguez, A. L.; Ariza-Montes, A. J.; Morales-Fernández, E.; Albort-Morant, G., 2017: Green innovation, indeed a cornerstone in linking market requests and business performance. Evidence from the Spanish automotive components industry. *Technological Forecasting and Social Change*, 129: 185-193. <https://doi.org/10.1016/j.techfore.2017.07.021>.
  18. Liao, Ch. S.; Chuang, H. K.; Gao, Ch. T., 2013: Going green: Integrating customer requirements into green product designs. Available online: <http://psrcentre.org/images/extramages/19%20812103.pdf> (Accessed April 9, 2018).
  19. Liu, Y.; Qu, Y.; Lei, Z.; Jia, H., 2017: Understanding the evolution of sustainable consumption research. *Sustainable development*, 25 (5): 414-430. <https://doi.org/10.1002/sd.1671>.
  20. Makatouni, A., 2002: What motivates consumers to buy organic food in the UK?: Results from a qualitative study. *British Food Journal*, 104 (3, 4, 5): 345-352. <https://doi.org/10.1108/00070700210425769>.
  21. Malá, D.; Sedliačiková, M.; Dusak, M.; Kaščáková, A.; Musová, Z.; Klementová, J., 2017a: Green Logistics in the Context of Sustainable Development in Small and Medium Enterprises. *Drvna industrija*, 68 (1): 69-79. <https://doi.org/10.5552/drind.2017.1620>.
  22. Malá, D.; Sedliačiková, M.; Kaščáková, A.; Benčíková, D.; Vavrová, K.; Bikar, M., 2017b: Green Logistics in Slovak Small and Medium Wood-Processing Enterprises. *BioResources*, 12 (3): 5155-5173. <https://doi.org/10.15376/biores.12.3.5155-5173>.
  23. Manget, J.; Roche, C.; Munnich, F., 2009: *Capturing the green advantage for Consumer companies*. Boston, USA: Boston Consulting Group.
  24. Musová, Z., 2013: *Spoločenská zodpovednosť v marketingovej praxi podnikov*. Banská Bystrica, SK: Univerzita Mateja Bela, Ekonomická fakulta v Banskej Bystrici.
  25. Norazah, M. S., 2016: Consumer environmental concern and green product purchase in Malaysia: Structural effects of consumption values. *Journal of Cleaner Production*, 132: 204-214. <https://doi.org/10.1016/j.jclepro.2015.09.087>.
  26. Paluš, H.; Parobek, J.; Volosky, R.; Motik, D.; Oblak, L.; Jošt, M.; Glavonjić, B.; Dudík, R.; Wanat, L., 2018: The status of chain-of custody certification in the countries of Central and South Europe. *European Journal of Wood and Wood Products*, 76: 669-710. <https://doi.org/10.1007/s00107-017-1261-0>.
  27. Pekkanen, T. L.; Patari, S.; Albadera, L.; Jantunen, A., 2018: Who cares about product sustainability information at the moment of Purchase? *Sustainable development*, 26 (3): 229-242. <https://doi.org/10.1002/sd.1697>.
  28. Pinto, D. C.; Herter, M. M.; Nique, W. M.; Borges, A., 2016: Green consumers and their identities: How identities change the motivation for green consumption. *International Journal of Consumer Studies*, 40 (6): 742-754. <https://doi.org/10.1111/ijcs.12282>.
  29. Roman, T.; Bostan, I.; Manolica, A.; Mitrica, I., 2015: Profile of green consumers in Romania in light of sustainability challenges and opportunities. *Sustainability*, 7 (6): 6394-6411. <https://doi.org/10.3390/su7066394>.
  30. Schiederig, T.; Tietze, F.; Herstatt, C., 2012: Green innovation in technology and innovation management – An exploratory literature review. *R&D Manager*, 42 (2): 180-192. <https://doi.org/10.1111/j.1467-9310.2011.00672.x>.
  31. Sedliačiková, M.; Hajduchová, I.; Krištofik, P.; Vizslai, I.; Gaff, M., 2016: Improving the Performance of Small and Medium Wood-Processing Enterprises. *BioResources*, 11 (1): 439-450. <https://doi.org/10.15376/biores.11.1.439-450>.
  32. Sedliačiková, M.; Volcko, I.; Jelacic, D., 2014: Factoring and Forfeiting in Slovakia and Possibilities of its Application in Wood-Working Industry. *Drvna industrija*, 65 (1): 51-57. <https://doi.org/10.5552/drind.2014.1304>.
  33. Shamraiz, A.; Wong, K. Y.; Tseng, M. L.; Wong, W. P., 2018: Sustainable product design and development: A review of tools, applications and research prospects. *Resource, Conservation and Recycling*, 132: 49-61. <https://doi.org/10.1016/j.resconrec.2018.01.020>.
  34. Shamsi, M. S.; Siddiqui, Z. S., 2017: Green Product and Consumer Behavior: An Analytical Study. *Pertanika Journal of Social Science and Humanities*, 25 (4): 1545-1554.
  35. Syaekhoni, M. A.; Alfian, G.; Kwon, Y. S., 2017: Customer purchasing behaviour analysis as alternatives for supporting in-store green marketing decision-making. *Sustainability*, 9 (11): 1-22. <https://doi.org/10.3390/su9112008>.
  36. Tanner, C.; Kast, W., 2003: Promoting sustainable consumption: Determinants of green purchases by Swiss consumers. *Psychology & Marketing*, 20 (10): 883-902. <https://doi.org/10.1002/mar.10101>.
  37. Tweeneboah, E.; Braimah, M., 2011: An exploratory study of the impact of green brand awareness on consumer purchase decisions in Ghana. *Journal of Marketing Development and Competitiveness*, 5: 11-18.

38. Vetráková, M.; Potkány, M.; Hitka, M., 2013: Outsourcing of facility management. *E+M Ekonomie a management*, 16 (1): 80-92.
39. Yang, L.; Dong, S., 2017: Sustainable product strategy in apparel industry with consumer behaviour consideration. *Sustainability*, 9 (6): 1-20.  
<https://doi.org/10.3390/su9060920>.
40. Zhou, Y.; Minshall, T., 2014: Building global products and competing in innovation: the role of Chinese university spin-outs and required innovation capabilities. *International Journal of Technology Management*, 64 (2, 3, 4): 180-209.  
<https://doi.org/10.1504/IJTM.2014.059929>.

**Corresponding address:**

DENISA MALÁ

Matej Bel University in Banská Bystrica  
Faculty of Economics  
Tajovského 10, 975 90 Banská Bystrica, SLOVAKIA  
e-mail: [denisa.mala@umb.sk](mailto:denisa.mala@umb.sk)

# DRVO BIJELOG HRASTA (*Quercus alba* L.)

## NAZIVI

*Quercus alba* L. naziv je drva botaničke vrste iz porodice *Fagaceae*. Trgovački su nazivi te vrste također: american white oak, true white oak, stave oak (SAD, Velika Britanija), amerikanische weißeiche (Njemačka), chéne blanc d'Amérique (Francuska), quercia bianca americana (Italija), bijeli hrast (Hrvatska).

## PODRUČJE RASPROSTRANJENOSTI

Stabla *Quercus alba* L. nalazimo na istoku Sjedinjenih Američkih država (Južni Maine, Jugoistočna Minnesota, Južni i Istočni Teksas, Sjeverna Florida); Kanada (Južni Quebec, Onatrio). Rastu u nizinskim i brežuljakstim predjelima, u zajednici s crvenim hrastom, hikorijem, eukaliptusom, magnolijom i američkim tulipanovcem.

## STABLO

Visina stabla doseže 15 – 20 (30) metara. Čisto deblo dugo je do 15 m, a prsni mu je promjer od 0,6 do 1,2 m. Debla su valjkastog oblika. Kora drva je debela, smeđa.

## DRVO

### Makroskopska obilježja

Bjeljika je bijelkasta do okerasta, a široka je 2 – 8 cm. Srž drva je žutosmeđa do svijetlosmeđa, katkad smeđa. Tekstura drva je gruba i dekorativna. Drvo je prstenasto porozno. Granica goda je vidljiva. Pore ranog drva i krupni drvni traci na poprečnom su presjeku dobro vidljivi golim okom, a pore kasnog drva vidljive su tek s povećalom. Krupni su drvni traci na tangencijalnom presjeku visoki do 40 mm.

### Mikroskopska obilježja

Drvo je prstenasto porozno. Traheje ranog drva pojedinačno su raspoređene ili se pojavljuju u parovima. Traheje kasnog drva raspoređene su radijalno klinasto. Promjer traheja ranog drva iznosi 100...325...425 mikrometara, a gustoća im je 2...3...5 na 1 mm<sup>2</sup> poprečnog presjeka. Promjer traheja kasnog drva je 20...30...40 mikrometara, a gustoća im je 26...38...50 na 1 mm<sup>2</sup> poprečnog presjeka. Volumni udio traheja iznosi oko 25 %.

Traheje ranog drva u srži su ispunjene tilama. Aksijalni je parenhim nepravilno vrpčast (vrlo je uzak), a u kasnom drvu „razbacan“ do mrežast. Volumni udio aksijalnog parenhima iznosi oko 4 %. Staničje drvnih trakova je homogeno.

Drvni se traci pojavljuju u dvije različite veličine, jednoredni i krupni. Jednoredni su visoki 30...40...65 mikrometara, a široki 6...16...24 mikrometara. Krupni su drvni traci visoki 90...260...480 mikrometara, a široki 100...215...300 mikrometara. Gustoća drvnih trakova je 8...9 na 12 mm. Njihov volumni udio iznosi oko 22 %. Drvna vlakanca su libriformska, vlaknaste i vazicentrične traheide. Dugačka su 1030...1360...1770 mikrometara. Debljina staničnih stijenki vlakanca iznosi 2,8...4,5...6,1 mikrometara, a promjeri njihovih lumena su 5,3...7,5...9,6 mikrometara. Volumni je udio vlakanca oko 49 %.

### Fizička svojstva

Gustoća apsolutno suhog drva, $\rho_0$	680...740...785 kg/m <sup>3</sup>
Gustoća prosušenog drva, $\rho_{12-15}$	710...775...820 kg/m <sup>3</sup>
Gustoća sirovog drva, $\rho_s$	oko 1000 kg/m <sup>3</sup>
Poroznost	oko 51 %
Radijalno utezanje, $\beta_r$	4,5...5,5...8,5 %
Tangentno utezanje, $\beta_t$	6,7...9,8...10,8 %
Volumno utezanje, $\beta_v$	11,3...15,6...20,4 %

### Mehanička svojstva

Mehanička svojstva	
Čvrstoća na tlak	46...52...55 MPa
Čvrstoća na vlak, okomito na vlakanca	2,6...4,0...8,6 MPa
Čvrstoća na savijanje	88...111...128 MPa
Čvrstoća na smik	oko 13 MPa
Tvrdoća po Brinellu, paralelno s vlakancima	41...50...61 MPa
Tvrdoća po Brinellu, okomito na vlakanca	27...31...44 MPa
Modul elastičnosti	12,3...15,1 GPa

### TEHNOLOŠKA SVOJSTVA

#### Obradivost

Drvo se dobro ručno i strojno obrađuje. Dobro se lijepi, površinski obrađuje, čavla i vijča. Preporučuje se provesti predušenje. Mokro drvo u dodiru sa željezom mijenja boju u plavo crnu.



### Sušenje

Drvo se dobro i polako suši. Ima malu sklonost promjeni oblika i raspucavanju.

### Trajnost i zaštita

Prema normi HRN 350-2, 2005, srž drva *Quercus alba* L. otporna je na gljive uzročnice truleži (razred otpornosti 2) i osjetljiva je na napad termita (razred otpornosti M). Srž je slabo permeabilna (razred 4). Po trajnosti pripada razredu 3 i stoga se nezaštićena može koristiti u interijeru i eksterijeru ali ne u dodiru s tlom.

### Uporaba

Drvo se upotrebljava za izradu furnira, namještaja, podova, prozora i vrata, stuba, željezničkih pragova, rudničkog drva, bačava, lijesova.

### Sirovina

Drvo se isporučuje u obliku trupaca, odnosno kao piljena građa.

### Napomena

*Quercus alba* za sada se ne nalazi na popisu ugroženih vrsta međunarodne organizacije CITES, niti na popisu međunarodne organizacije IUCN. Vodi se kao vrsta drva najmanje zabrinjavajućeg opstanka. Drvo sličnih svojstava imaju vrste *Quercus macrocarpa* Michx., *Q. muehlenbergii* Engelm., *Q. lyrata* Walt., *Q. stellata* Wangenh., *Q. michauxii* Nutt., *Q. prinus* L., *Q. bicolor* Willd., *Q. alba* var. *latiloba* Sarg. Svih osam navedenih vrsta pripadaju skupini bijelih hrastova među koje se ubrajaju i europski *Q. robur* L. i *Q. petraea* (Matt.) Liebl. U uporabi se drvo *Q. alba* može zamijeniti drvom prvih dviju vrsta. Na lokalnim su tržištima bijeli hrastovi poznati i pod imenom rock oak, basket oak, yellow oak, cow oak. Glede tehničkih svojstava drva, razlike među tim vrstama vrlo su malene. Općenito, drvo svih nabrojenih američkih i europskih hrastova iz iste sekcije (*Leucobalanus*) po tehničkim se svojstvima neznatno razlikuju.

prof. dr. sc. Jelena Trajković  
izv. prof. dr. sc. Bogoslav Šefer

## Upute autorima

### Opće odredbe

Časopis *Drvna industrija* objavljuje znanstvene radove (izvorne znanstvene radove, pregledne radove, prethodna priopćenja), stručne radove, izlaganja sa savjetovanja, stručne obavijesti, bibliografske radove, pregledne te ostale priloge s područja biologije, kemije, fizike i tehnologije drva, pulpe i papira te drvnih proizvoda, uključujući i proizvodnu, upravljačku i tržišnu problematiku u drvenoj industriji. Predaja rukopisa podrazumijeva uvjet da rad nije već predan negdje drugdje radi objavljivanja ili da nije već objavljen (osim sažetka, dijelova objavljenih predavanja ili magistarskih radova odnosno disertacija, što mora biti navedeno u napomeni) te da su objavljivanje odobrili svi suautori (ako rad ima više autora) i ovlaštene osobe ustanove u kojoj je istraživanje provedeno. Cjelokupni sadržaj Drvne industrije dostupan je za skidanje s interneta, tiskanje, daljnju distribuciju, čitanje i ponovno korištenje bez ograničenja sve dok se naznače autor(i) i originalni izvor prema Creative Commons Attribution 4.0 International License (CC BY). Autor(i) zadržavaju izdavačka prava bez ograničenja. Znanstveni i stručni radovi objavljuju se na hrvatskome, uz sažetak na engleskome, ili se pak rad objavljuje na engleskome, sa sažetkom na hrvatskom jeziku. Naslov, podnaslovi i svi važni rezultati trebaju biti napisani dvojezično. Ostali se članci uglavnom objavljuju na hrvatskome. Uredništvo osigurava inozemnim autorima prijevod na hrvatski. Znanstveni i stručni radovi podliježu temeljitoj recenziji najmanje dvaju recenzentata. Izbor recenzentata i odluku o klasifikaciji i prihvatanju članka (prema preporukama recenzentata) donosi Urednički odbor.

Svi prilozi podvrgavaju se jezičnoj obradi. Urednici će od autora zahtijevati da tekst prilagode preporukama recenzentata i lektora, te zadržavaju i pravo da predlože skraćivanje ili poboljšanje teksta. Autori su potpuno odgovorni za svoje priloge. Podrazumijeva se da je autor pribavio dozvolu za objavljivanje dijelova teksta što su već negdje objavljeni te da objavljivanje članka ne ugrožava prava pojedinca ili pravne osobe. Radovi moraju izvještavati o istinitim znanstvenim ili tehničkim postignućima. Autori su odgovorni za terminološku i metrološku usklađenost svojih priloga. Radovi se šalju elektroničkom poštom na adresu:

drind@sumfak.hr ili techdi@sumfak.hr

### Upute

Predani radovi smiju sadržavati najviše 15 jednostrano pisanih A4 listova s dvostrukim proredom (30 redaka na stranici), uključujući i tablice, slike te popis literature, dodatke i ostale priloge. Dulje je članke preporučljivo podijeliti na dva ili više nastavaka. Tekst treba biti u *doc formatu*, u potpunosti napisan fontom *Times New Roman* (tekst, grafikoni i slike), normalnim stilom, bez dodatnog uređenja teksta.

Prva stranica poslanog rada treba sadržavati puni naslov, ime(na) i prezime(na) autora, podatke o zaposlenju autora (ustanova, grad i država) te sažetak s ključnim riječima (duljina sažetka približno 1/2 stranice A4).

Posljednja stranica treba sadržavati titule, zanimanje, zvanje i adresu (svakog) autora, s naznakom osobe s kojom će Uredništvo biti u vezi.

Znanstveni i stručni radovi moraju biti sažeti i precizni. Osnovna poglavlja trebaju biti označena odgovarajućim podnaslovima. Napomene se ispisuju na dnu pripadajuće stranice, a obročavaju se susljedno. One koje se odnose na naslov označuju se zvjezdicom, a ostale uzdignutim arapskim brojkama. Napomene koje se odnose na tablice pišu se ispod tablica, a označavaju se uzdignutim malim pisanim slovima, abecednim redom.

Latinska imena trebaju biti pisana kosim slovima (*italicom*), a ako je cijeli tekst pisan kosim slovima, latinska imena trebaju biti podcrtana.

U uvodu treba definirati problem i, koliko je moguće, predočiti granice postojećih spoznaja, tako da se čitateljima koji se ne bave područjem o kojemu je riječ omogući razumijevanje ciljeva rada.

Materijal i metode trebaju biti što preciznije opisane da omoguće drugim znanstvenicima ponavljanje pokusa. Glavni eksperimentalni podaci trebaju biti dvojezično navedeni.

Rezultati trebaju obuhvatiti samo materijal koji se izravno odnosi na predmet. Obvezatna je primjena metričkog sustava. Preporučuje se upotreba SI jedinica. Rjeđe rabljene fizikalne vrijednosti, simboli i jedinice trebaju biti objašnjeni pri njihovu prvom spominjanju u tekstu. Za pisanje formula valja se koristiti Equation Editorom (programom za pisanje formula u MS Wordu). Jedinice se pišu normalnim (uspravnim) slovima, a fizikalni simboli i faktori kosima (*italicom*).

Formule se susljedno obročavaju arapskim brojkama u zagradama, npr. (1) na kraju retka.

Broj slika mora biti ograničen samo na one koje su prijeko potrebne za objašnjenje teksta. Isti podaci ne smiju biti navedeni i u tablici i na slici. Slike i tablice trebaju biti zasebno obročane, arapskim brojkama, a u tekstu se na njih upućuje jasnim naznakama ("tablica 1" ili "slika 1"). Naslovi, zaglavlja, legende i sav ostali tekst u slikama i tablicama treba biti napisan hrvatskim i engleskim jezikom.

Slike je potrebno rasporediti na odgovarajuća mjesta u tekstu, trebaju biti izrađene u rezoluciji 600 dpi, crno-bijele (objavljivanje slika u koloru moguće je na zahtjev autora i uz posebno plaćanje), formata jpg ili tiff, potpune i jasno razumljive bez pozivanja na tekst priloga.

Svi grafikoni i tablice izrađuju se kao crno-bijeli prilozi (osim na zahtjev, uz plaćanje). Tablice i grafikoni trebaju biti na svojim mjestima u tekstu te originalnog formata u kojemu su izrađeni radi naknadnog ubacivanja hrvatskog prijevoda. Ako ne postoji mogućnost za to, potrebno je poslati originalne dokumente u formatu u kojemu su napravljeni (*excel* ili *statistica* format).

Naslovi slika i crteža ne pišu se velikim tiskanim slovima. Crteži i grafikoni trebaju odgovarati stilu časopisa (fontovima i izgledu). Slova i brojke moraju biti dovoljno veliki da budu lako čitljivi nakon smanjenja širine slike ili tablice. Fotomikrografije moraju imati naznaku uvećanja, poželjno u mikrometrima. Uvećanje može biti dodatno naznačeno na kraju naslova slike, npr. "uvećanje 7500 : 1".

Diskusija i zaključak mogu, ako autori žele, biti spojeni u jedan odjeljak. U tom tekstu treba objasniti rezultate s obzirom na problem postavljen u uvodu i u odnosu prema odgovarajućim zapažanjima autora ili drugih istraživača. Valja izbjegavati ponavljanje podataka već iznesenih u odjeljku *Rezultati*. Mogu se razmotriti naznake za daljnja istraživanja ili primjenu. Ako su rezultati i diskusija spojeni u isti odjeljak, zaključke je nužno napisati izdvojeno. Zahvale se navode na kraju rukopisa. Odgovarajuću literaturu treba citirati u tekstu, i to prema harvardskom sustavu (*ime – godina*), npr. (Bađun, 1965). Nadalje, bibliografija mora biti navedena na kraju teksta, i to abecednim redom prezimena autora, s naslovima i potpunim navodima bibliografskih referenci. Popis literature mora biti selektivan, a svaka referenca na kraju mora imati naveden DOI broj, ako ga posjeduje (<http://www.doi.org>) (provjeriti na <http://www.crossref.org>).

### Primjeri navođenja literature

Članci u časopisima: Prezime autora, inicijal(i) osobnog imena, godina: Naslov. Naziv časopisa, godište (ev. broj): stranice (od – do).  
Doi broj.

Primjer

Kärki, T., 2001: Variation of wood density and shrinkage in European aspen (*Populus tremula*). Holz als Roh- und Werkstoff, 59: 79-84. <http://dx.doi.org/10.1007/s001070050479>.

Knjige: Prezime autora, inicijal(i) osobnog imena, godina: Naslov. (ev. izdavač/editor): izdanje (ev. svezak). Mjesto izdanja, izdavač (ev. stranice od – do).

Primjeri

Krpan, J., 1970: Tehnologija furnira i ploča. Drugo izdanje. Zagreb, Tehnička knjiga.

Wilson, J. W.; Wellwood, R. W., 1965: Intra-increment chemical properties of certain western Canadian coniferous species. U: W. A.

Cote, Jr. (Ed.): Cellular Ultrastructure of Woody Plants. Syracuse, N.Y., Syracuse Univ. Press, pp. 551- 559.

Ostale publikacije (brošure, studije itd.)

Müller, D., 1977: Beitrag zur Klassifizierung asiatischer Baumarten. Mitteilung der Bundesforschungsanstalt für Forstund Holzvvirt schaft Hamburg, Nr. 98. Hamburg: M. Wiederbusch.

Web stranice

\*\*\*1997: "Guide to Punctuation" (online), University of Sussex, [www.informatics.sussex.ac.uk/departments/docs/punctuation/node00.html](http://www.informatics.sussex.ac.uk/departments/docs/punctuation/node00.html). First published 1997 (pristupljeno 27. siječnja 2010).

Autoru se prije konačnog tiska šalje pdf rada. Rad je potrebno pažljivo pročitati, ispraviti te vratiti Uredništvu s listom ispravaka te s formularom za prijenos autorskih prava na izdavača. Ispravci su ograničeni samo na tiskarske pogreške: dodaci ili znatnije promjene u radu naplaćuju se. Autori znanstvenih i stručnih radova besplatno dobivaju po jedan primjerak časopisa. Autoru svakog priloga također se dostavlja besplatan primjerak časopisa.

Dodatne informacije o načinu pisanja znanstvenih radova mogu se naći na web adresi:

[www.ease.org.uk/publications/author-guidelines](http://www.ease.org.uk/publications/author-guidelines)

## Instructions for authors

### General terms

The “Drvna industrija” (“Wood Industry”) journal publishes scientific papers (original scientific papers, review papers, previous notes), professional papers, conference papers, professional information, bibliographical and survey articles and other contributions related to biology, chemistry, physics and technology of wood, pulp and paper and wood products, including production, management and marketing issues in the wood industry.

Submission of a paper implies that the work has not been submitted for publication elsewhere or published before (except in the form of an abstract or as part of a published lecture, review or thesis, in which case it must be stated in a footnote); that the publication is approved by all co-authors (if any) and by the authorities of the institution where the research has been carried out. The complete content of the journal *Drvna industrija* (Wood Industry) is available on the Internet permitting any users to download, print, further distribute, read and reuse it with no limits provided that the author(s) and the original source are identified in accordance with the Creative Commons Attribution 4.0 International License (CC BY). The authors retain their copyrights.

The scientific and professional papers shall be published either in Croatian, with an extended summary in English, or in English with an extended summary in Croatian. The titles, headings and all the relevant results shall be presented bilingually. Other articles are generally published in Croatian. The Editor’s Office shall provide the translation into Croatian for foreign authors. The scientific and professional papers will be subject to a thorough review by at least two selected referees. The Editorial Board shall make the choice of reviewers, as well as the decision about the classification of the paper and its acceptance (based on reviewers’ recommendations).

All contributions are subject to proofreading. The editors will require authors to modify the text in the light of the recommendations made by reviewers and language advisers, and they reserve the right to suggest abbreviations and text improvements. Authors are fully responsible for the contents of their contributions. It shall be assumed that the author has obtained the permission for the reproduction of portions of text published elsewhere, and that the publication of the paper in question does not infringe upon any individual or corporate rights. Papers shall report on true scientific or technical achievement. Authors are responsible for the terminological and metrological consistency of their contributions. The contributions are to be submitted by e-mail to the following address: E-mail: [drind@sumfak.hr](mailto:drind@sumfak.hr)

### Details

Papers submitted shall consist of no more than 15 single-sided DIN A-4 sheets of 30 double-spaced lines, including tables, figures and references, appendices and other supplements. Longer papers should be divided into two or more continuing series. The text should be written in doc format, fully written using Times New Roman font (text, graphs and figures), in normal style without additional text editing.

The first page of the paper submitted should contain full title, name(s) of author(s) with professional affiliation (institution, city and state), abstract with keywords (approx. 1/2 sheet DIN A4).

The last page should provide the full titles, posts and address(es) of each author with indication of the contact person for the Editor’s Office.

Scientific and professional papers shall be precise and concise. The main chapters should be characterized by appropriate headings. Footnotes shall be placed at the bottom of the same page and consecutively numbered. Those relating to the title should be marked by an asterisk, others by superscript Arabic numerals. Footnotes relating to the tables shall be printed under the table and marked by small letters in alphabetical order.

Latin names shall be printed in italics and underlined.

Introduction should define the problem and if possible the framework of existing knowledge, to ensure that readers not working in that particular field are able to understand author’s intentions.

Materials and methods should be as precise as possible to enable other scientists to repeat the experiment. The main experimental data should be presented bilingually.

The results should involve only material pertinent to the subject. The metric system shall be used. SI units are recommended. Rarely used physical values, symbols and units should be explained at their first appearance in the text. Formulas should be written by using Equation Editor (program for writing formulas in MS Word). Units shall be written in normal (upright) letters, physical symbols and factors in italics. Formulas shall be consecutively numbered with Arabic numerals in parenthesis (e.g. (1)) at the end of the line.

The number of figures shall be limited to those absolutely necessary for clarification of the text. The same information must not be presented in both a table and a figure. Figures and tables should be numbered separately with Arabic numerals, and should be referred to in the text with clear remarks (“Table 1” or “Figure 1”). Titles, headings, legends and all the other text in figures and tables should be written in both Croatian and English.

Figures should be inserted into the text. They should be of 600 dpi resolution, black and white (color photographs only on request and extra charged), in jpg or tiff format, completely clear and understandable without reference to the text of the contribution.

All graphs and tables shall be black and white (unless requested otherwise with additional payment). Tables and graphs should be inserted into the text in their original format in order to insert them subsequently into the Croatian version. If this is not possible, original document should be sent in the format in which it was made (excel or statistica format).

The captions to figures and drawings shall not be written in block letters. Line drawings and graphs should conform to the style of the journal (font size and appearance). Letters and numbers shall be sufficiently large to be readily legible after reduction of the width of a figure or table. Photomicrographs should have a mark indicating magnification, preferably in micrometers. Magnification can be additionally indicated at the end of the figure title, e.g. “Mag. 7500:1”. Discussion and conclusion may, if desired by authors, be combined into one chapter. This text should interpret the results relating to the problem outlined in the introduction and to related observations by the author(s) or other researchers. Repeating the data already presented in the “Results” chapter should be avoided. Implications for further studies or application may be discussed. A conclusion shall be expressed separately if results and discussion are combined in the same chapter. Acknowledgements are presented at the end of the paper. Relevant literature shall be cited in the text according to the Harvard system (“name – year”), e.g. (Badun, 1965). In addition, the bibliography shall be listed at the end of the text in alphabetical order of the author’s names, together with the title and full quotation of the bibliographical reference. The list of references shall be selective, and each reference shall have its DOI number (<http://www.doi.org>) (check at <http://www.crossref.org>).

### Example of references

Journal articles: Author’s second name, initial(s) of the first name, year: Title. Journal name, volume (ev. issue): pages (from - to). DOI number.

Example:

Kärki, T., 2001: Variation of wood density and shrinkage in European aspen (*Populus tremula*). *Holz als Roh- und Werkstoff*, 59: 79-84. <http://dx.doi.org/10.1007/s001070050479>.

Books:

Author’s second name, initial(s) of the first name, year: Title. (ev. Publisher/editor): edition, (ev. volume). Place of publishing, publisher (ev. pages from - to).

Examples:

Krpan, J. 1970: *Tehnologija furnira i ploča*. Drugo izdanje. Zagreb: Tehnička knjiga.

Wilson, J.W.; Wellwood, R.W. 1965: Intra-increment chemical properties of certain western Canadian coniferous species. U: W.

A. Cote, Jr. (Ed.): *Cellular Ultrastructure of Woody Plants*. Syracuse, N.Y., Syracuse Univ. Press, pp. 551-559.

Other publications (brochures, studies, etc.):

Müller, D. 1977: Beitrag zur Klassifizierung asiatischer Baumarten. Mitteilung der Bundesforschungsanstalt für Forst- und Holzwirtschaft Hamburg, Nr. 98. Hamburg: M. Wiederbusch.

Websites:

\*\*\*1997: “Guide to Punctuation” (online), University of Sussex, [www.informatics.sussex.ac.uk/department/docs/punctuation/node00.html](http://www.informatics.sussex.ac.uk/department/docs/punctuation/node00.html). First published 1997 (Accessed Jan. 27, 2010).

The paper will be sent to the author in pdf format before printing. The paper should be carefully corrected and sent back to the Editor’s Office with the list of corrections made and the form for the transfer of copyrights from the author to the publisher. Corrections should be limited to printing errors; amendments to or changes in the text will be charged. Each contributor will receive 1 copy of the journal.

Further information on the way of writing scientific papers can be found on the following website:

[www.ease.org.uk/publications/author-guidelines](http://www.ease.org.uk/publications/author-guidelines)

# BERNARDA

## KREVETI I MADRACI

dobar san za  
zdrav život



- inovativni individualno prilagođeni kreveti i madraci u veličinama prema želji
- visokokvalitetni kreveti i madraci za hotele, pansionere i apartmane
- kutne garniture, pomoćni ležajevi
- vrhunski ergonomski antibakterijski jastuci
- dječji antibakterijski madraci
- medicinski antidekubitalni madraci i jastuci
- krevetni sustavi za plovila

Inovativnost naših proizvoda potvrđena je mnogobrojnim nagradama diljem Europe



# Bernarda

tourism

Provedite trenutke opuštanja u našim turističkim objektima na otoku Krku ili Varaždinskim Toplicama



vile Bernarda - otok Krk



sobe i apartmani Bernarda - Varaždinske Toplice

THERMODOMINUS

THERMODUX

THERMOREX



GALEKOVIĆ

*Kvaliteta u tradiciji*



#### Tvornica parketa

DUX: Gotovi lakirani masivni klasični parket

DOMINUS: Gotovi lakirani masivni klasični parket - širina 9 cm

REX: Gotovi masivni lakirani podovi - uljeni / lakirani

Termo tretirani podovi: THERMODUX, THERMODOMINUS, THERMOREX

Eksterijeri: fasade, decking



PPS Galeković | Braće Radića 199 A, 10410 Mraclin

Tel.: +385 (0)1 6268 460 • Fax: +385 (0)1 6268 260 | [www.pps-galekovic.hr](http://www.pps-galekovic.hr) | [prodaja@pps-galekovic.hr](mailto:prodaja@pps-galekovic.hr)